



QW-HY15F49EI-ES

QW-HY15F49EW-ES

Dishwasher

EN User Manual





SHARP

Be Original.

Thank you for choosing this product.

This User Manual contains important information on safety and instructions intended to assist you in the operation and maintenance of your appliance.

Please take the time to read this User Manual before using your appliance and keep this book for future reference.

| Icon | Type | Meaning |
|--|-------------------------------|--|
|  | WARNING | Serious injury or death risk |
|  | RISK OF ELECTRIC SHOCK | Dangerous voltage risk |
|  | FIRE | Warning; Risk of fire / flammable materials. |
|  | CAUTION | Injury or property damage risk |
|  | IMPORTANT / NOTE | Operating the system correctly |

CONTENTS

| | |
|--|-----------|
| 1.SAFETY INSTRUCTIONS | 1 |
| 1.1. General Safety Warnings | 1 |
| 1.2. Installation Warnings | 2 |
| 1.3. During Use..... | 3 |
| 2.INSTALLATION | 6 |
| 2.1. Machine Positioning | 6 |
| 2.2. Water Connection | 6 |
| 2.3. Water Inlet Hose | 6 |
| 2.4. Electrical Connection | 7 |
| 2.5. Fitting the Machine Undercounter | 7 |
| 3.TECHNICAL SPECIFICATIONS | 8 |
| 3.1. General Appearance..... | 8 |
| 3.2. Technical Specifications | 8 |
| 4.BEFORE USING THE APPLIANCE | 9 |
| 4.1. Preparing your Dishwasher for first use | 9 |
| 4.2. Salt usage..... | 9 |
| 4.3. Fill the salt | 9 |
| 4.4. Test Strip | 10 |
| 4.5. Water Hardness Table | 10 |
| 4.6. Water Softener System | 10 |
| 4.7. Setting | 10 |
| 4.8. Detergent Usege | 10 |
| 4.9. Filling the Detergent | 11 |
| 4.10. Using Combined Detergents | 11 |
| 4.11. Rinse-aid Usege | 11 |
| 4.12. Filling the Rinse-aid and Setting | 11 |
| 5.LOADING YOUR DISHWASHER | 13 |
| 5.1. Recommendations..... | 13 |
| 5.2. Alternative Basket Loads | 16 |
| 6.PROGRAMME TABLE | 17 |
| 7.THE CONTROL PANEL | 19 |
| 7.1. Changing a Programme | 20 |
| 7.2. Cancelling a Programme | 20 |
| 7.3. Switching the Machine Off..... | 20 |

| | |
|---|-----------|
| 8.CLEANING AND MAINTENANCE | 22 |
| 8.1. Filters | 22 |
| 8.2. Spray Arms | 22 |
| 8.3. Drain Pump | 22 |
| 9.TROUBLESHOOTING | 24 |

1. SAFETY INSTRUCTIONS

1. General Safety Warnings

- Read these instructions carefully before using your appliance and keep this manual for future reference.

 Please check the packaging of your machine before installation and the outer surface of the machine once the packaging has been removed. Do not operate the machine if it appears damaged or if the packaging has been opened.

- Packaging materials protect your machine from any damage that might occur during transportation. The packaging materials are environmentally friendly as they are recyclable. Use of recycled material reduces raw material consumption and decreases waste production.

 This appliance can be used by children aged from 8 years and above, and by persons with reduced physical, sensory or mental capabilities or lack of experience and knowledge if they have been given supervision or instruction concerning the use of the appliance in a safe way and understand hazards involved. Children should not be allowed to play with the appliance.

 Remove packaging and keep it out of reach of children.

 Keep children away from detergents and rinse aids.

 There may be some residue left in the machine after washing. Keep children away from the machine when it is open.

2. Installation Warnings

- Choose a suitable and safe place to install your machine.
- Only original spare parts should be used with the machine.

 Unplug the machine before installation.

 Your machine must only be installed by an authorised service agent. Installation by anyone other than an authorised agent may cause your warranty to be void.

 Check that the indoor electrical fuse system is connected in line with safety regulations.

 All electrical connections must match the values on the plate.

 Ensure the machine does not stand on the electrical supply cable.

 Never use an extension cord or a multiple socket connection.

 The plug should be accessible after the machine is installed.

- After installation, run your machine unloaded for the first time.

 The machine must not be plugged in during positioning.

 Always use the coated plug supplied with your machine.

 If the electrical cable is damaged, it should only be replaced by a qualified electrician.

- Connect the hose directly to the water inlet tap. The pressure supplied by the tap should be a minimum of 0.03 MPa and a maximum of 1 MPa. If the

pressure exceeds 1 MPa, a pressure relief valve must be fitted between the connection.

3. During Usage

- This machine is for domestic use only; do not use it for other purposes. Commercial use will void the guarantee.

 Do not stand, sit or place loads on the open door of the dishwasher.

 Only use detergents and rinse aids produced specifically for dishwashers. Our company is not responsible for any damage that may occur due to misuse.

 Do not drink water from the machine.

 Due to the danger of explosion, do not place any chemical dissolving agents into the machine's washing section.



- Check the heat-resistance of plastic items before washing them in the machine.

 Only put items in the machine which are suitable for dishwashing, and take care not to overfill the baskets.

 Do not open the door while the machine is in operation, hot water may spill out. Safety devices ensure the machine stops if the door is opened.

 The machine door should not be left open. It may cause accidents.

 Place knives and other sharp objects in the cutlery basket in a blade-down position.

  For models with the automatic door-opening system, when the EnergySave option is active, the door will open at the end of a program. To prevent damage to your dishwasher, do not attempt to close

the door for one minute after it has opened. For effective drying, keep the door open for 30 minutes after a programme has ended. Do not stand in front of the door after the auto-open signal sounds.

 In the case of a malfunction, repair should only be performed by an authorised service company, otherwise the warranty will be void.

 Before repair work, the machine should be disconnected from the mains. Do not pull the cable to unplug the machine. Switch off the water tap.

 Operation at a low voltage will cause a decline in performance levels.

 For safety, disconnect the plug once a program has finished.

 To avoid an electric shock, do not unplug the machine with wet hands.

 Pull the plug to disconnect the machine from the mains, never pull on the cord.

RECYCLING

- Some machine components and packaging consist of recyclable materials.
- Plastics are marked with the international abbreviations: (>PE<, >PP<, etc.)
- The cardboard parts consist of recycled paper. They can be put into waste paper containers for recycling.
- Material unsuitable for domestic waste must be disposed of at recycling centres.
- Contact a relevant recycling centre to obtain information about disposal of different materials.

PACKAGING AND THE ENVIRONMENT

- Packaging materials protect your machine from damage that may occur during transportation. The packaging materials are environmentally friendly as they are recyclable. The use of recycled material reduces raw material consumption and therefore decreases waste production.

CE Declaration of Conformity

We declare that our products meet the applicable European Directives, Decisions and Regulations and the requirements listed in the standards referenced.

Disposal of your old machine



The symbol on the product or on its packaging indicates that this product may not be treated as household waste. Instead, it shall be handed over to the applicable collection point for the recycling of electrical and electronic equipment. By ensuring this product is disposed of correctly, you will help prevent potential negative consequences for the environment and human health, which could otherwise be caused by inappropriate waste handling of this product. For more detailed information about recycling of this product,

please contact your local city office, your household waste disposal service or the shop where the product was purchased.

2. INSTALLATION

2.1. Machine positioning

When positioning the machine, place it in an area where dishes can be easily loaded and unloaded. Do not put the machine in an area where the ambient temperature falls below 0°C.

Read all warnings located on the packaging before removing the packaging and positioning the machine.

Place the machine close to a water tap and drain. Take into consideration that the connections will not be altered once the machine is in position.

Do not hold the machine by its door or panel.

Leave an adequate distance around the machine to allow ease of movement when cleaning.



Ensure the water inlet and outlet hoses are not squeezed or trapped and that the machine does not stand on the electrical cable while positioning.

Adjust the feet so the machine is level and balanced. The machine should be placed on flat ground otherwise it will be unstable and the door of the machine will not close properly.

2.2. Water connection

We recommend fitting a filter to your water inlet supply in order to prevent damage to your machine due to contamination (sand, rust, etc.) from indoor plumbing. This will also help prevent yellowing and deposit formation after washing.

Note printing on the water inlet hose! If models are marked with 25°, the water temperature may be max. 25 °C (cold water).

For all other models:

Cold water preferred; hot water max. temperature 60 °C.

2.3. Water inlet hose



WARNING: Use the new water inlet hose supplied with your machine, do not use an old machine's hose.



WARNING: Run water through the new hose before connecting.



WARNING: Connect the hose directly to the water inlet tap. The pressure supplied by the tap should be a minimum of 0.03 MPa and a maximum of 1 MPa. If the pressure exceeds 1 MPa, a pressure relief valve must be fitted between the connection.



WARNING: After the connections are made, turn the tap on fully and check for water leaks. Always turn off the water inlet tap after a wash program has finished.

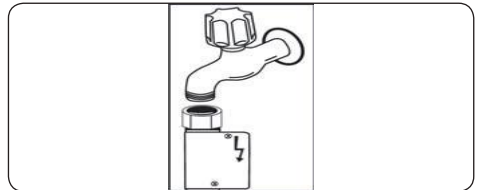

An Aquastop water spout is available with some models. Do not damage it or allow it to become kinked or twisted.

2.4. Electrical connection

! **WARNING:** Your machine is set to operate at 220-240 V. If the mains voltage supply to your machine is 110 V, connect a transformer of 110/220 V and 3000 W between the electrical connection.

! **!** **Connect the product to a grounded outlet protected by a fuse complying with the values in the "Technical Specifications" table.**

! **!** **The earthed plug of the machine must be connected to an earthed outlet supplied by suitable voltage and current.**

! **!** **In the absence of earthing installation, an authorised electrician should carry out an earthing installation. In the case of use without earthing installed, we will not be responsible for any loss of use that may occur.**

! **!** **The plug on this appliance may incorporate 13A fuse depending on the target country. (For Example UK, Saudi Arabia)**

2.5. Fitting the machine undercounter

If you wish to fit your machine undercounter, there must be sufficient space to do so and the wiring-plumbing must be suitable to do so (1). If the space under the countertop is suitable for fitting your machine, remove the worktop as shown in the illustration (2).

! **WARNING:** The countertop, of which the machine will be placed under, must be stable in order to prevent imbalance.

The top panel of the dishwasher must be removed to fit the machine under the countertop.

To remove the top panel, remove the screws that hold it on, located at the rear of the machine. Then, push the panel 1 cm from the front towards the rear and lift it. Adjust the machine feet according to the slope of the floor (3).

Fit your machine by pushing it under the counter taking care not to crush or bend the hoses (4).

! **WARNING:** After removing the top panel of your dishwasher, the machine should be placed in a space of the dimensions shown in the figure below.

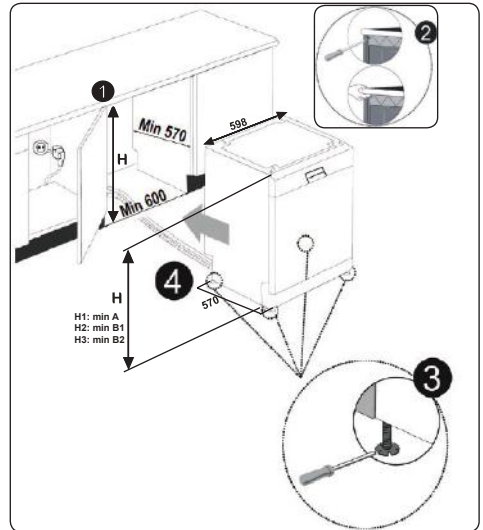

| | A | B | |
|--------------------------|--------------|----------------|----------------|
| | All Products | B ₁ | B ₂ |
| Product's Height (±2 mm) | 820 mm | 830 mm | 835 mm |

A: If there is no felt on the top of the product; you should take into account this product's height.

B1: If there is felt on the top of the product with 2nd basket; you should take into account this product's height.

B2: If there is felt on the top of the product with 3rd basket; you should take into account this product's height.

3. TECHNICAL SPECIFICATIONS

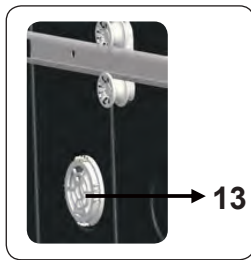
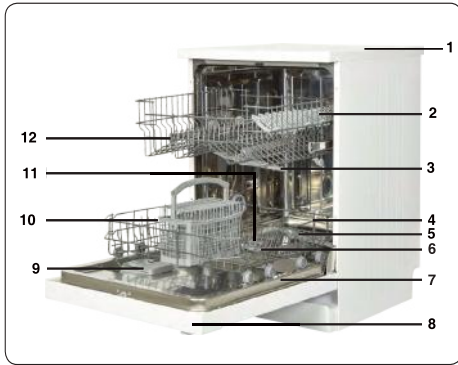

3.1. General appearance

1. Worktop
2. Upper basket with racks
3. Upper spray arm
4. Lower basket
5. Lower spray arm
6. Filters
7. Rating plate
8. Control panel
9. Detergent and rinse-aid dispenser
10. Cutlery basket
11. Salt dispenser
12. Upper basket track latch
13. Super Active Drying Unit: This system provides better drying performance your dishes.

3.2. Technical specifications

| | |
|-------------------------------|---|
| Capacity | 13 place settings |
| Dimensions | |
| Height | 850(mm) |
| Width | 598(mm) |
| Depth | 598(mm) |
| Net weight | 46 (kg) |
| Operating voltage / frequency | 220-240V 50 (Hz) |
| Total current | 10(A) |
| Total power | 1900(W) |
| Water supply pressure | Maximum: 1 (Mpa) Minimum: 0.03 (Mpa) |

4. BEFORE USING THE APPLIANCE

4.1. Preparing your dishwasher for first use

- Make sure the electricity and supply water specifications match the values indicated in the installation instructions for the machine.
- Remove all packaging material inside the machine.
- Set the water softener level.
- Fill the rinse aid compartment.

4.2 Salt usage (IF AVAILABLE)

For a good washing function, the dishwasher needs soft, i.e. less calcareous water. Otherwise, White lime residues will remain on the dishes and the interior equipment. This will negatively affect your machine's washing, drying and shining performance. When water flows through the softener system, the ions forming the hardness are removed from the water and the water reaches the softness required to obtain the best washing result. Depending on the level of hardness of the inflowing water, these ions that harden the water accumulate rapidly inside the softener system. Therefore, the softener system has to be refreshed so that it operates with the same performance also during the next wash. For this purpose, dishwasher salt is used.

Machine can only be used by special dishwasher salt to soften the water. Do not use any small grained or powdered type of salts which can easily soluble. Using any other type of salt can damage your machine.

4.3 Fill the salt (IF AVAILABLE)

To add softener salt, open the salt compartment cap by turning it counter clockwise. **(1)** **(2)** At first use, fill the compartment with 1 kg salt and water **(3)** until it is almost overflowing. If available, using a funnel **(4)** will make filling easier. Replace the cap and close it. After every 20-30 Cycles add salt into your machine until it fills up (approx. 1 kg).

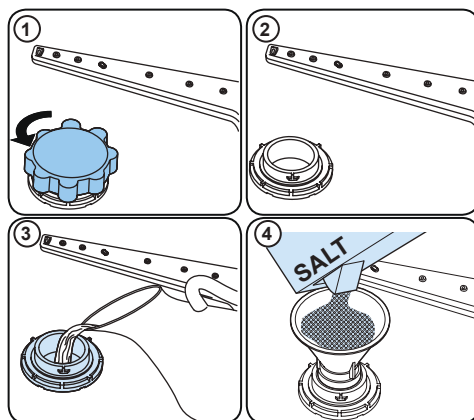







Only add water to the salt compartment on first use.

Use softener salt specifically produced for use in dishwashers.

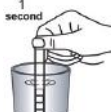
When you start your dishwasher, the salt compartment is filled with water, therefore put the softener salt in prior to starting your machine.

If the softener salt has overflowed and you do not start the machine immediately, run a short washing program to protect your machine against corrosion.

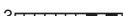
4.4. Test Strip

| Run water through the tap (1min.) | Keep the strip in the water (1sec) | Shake the strip. | Wait (1min.) | Set the hardness level of your machine. |
|--|---|---|---|--|
|  |  |  |  | 1  2  3  4  5  6  |

NOTE: The level is set to 3 as default. If the water is well water or has a hardness level above 90 dF, we recommend that you use filter and refinement devices.

4.5. Water Hardness Table

| Level | German dH | French dF | British dE | Indicator |
|-------|-----------|-----------|------------|-----------------------------|
| 1 | 0-5 | 0-9 | 0-6 | L1 is shown on the display. |
| 2 | 6-11 | 10-20 | 7-14 | L2 is shown on the display. |
| 3 | 12-17 | 21-30 | 15-21 | L3 is shown on the display. |
| 4 | 18-22 | 31-40 | 22-28 | L4 is shown on the display. |
| 5 | 23-31 | 41-55 | 29-39 | L5 is shown on the display. |
| 6 | 32-50 | 56-90 | 40-63 | L6 is shown on the display. |

4.6. Water Softener System

The dishwasher is equipped with a water softener which reduces the hardness in the mains water supply. To find out the hardness level of your tap water, contact your water company or use a test strip (if available).

4.7. Setting

- Press program button when the machine is off position.
- Turn on the machine by pressing On/Off button and continue to press program button at least for 3 seconds.
- If "Hardness set" is recognized "SL" is shown for 2 seconds.
- Release program button. The last setting level is viewed.
- Press program button to set the desired level. At any pressure of program button hardness level is incremented. Hardness level 1 returns after hardness level 6.
- The last selected water hardness level is stored in the memory by turning the machine off with On/Off button.

4.8. Detergent usage

Only use detergents specifically designed for domestic dishwashers. Keep your detergents in cool, dry places out of reach of children.

Add the proper detergent for the selected program to ensure the best performance. The amount of detergent needed depends on the cycle, load size, and soil level of dishes.

Do not fill detergent into the detergent compartment more than required; otherwise you can see whitish streaks or bluish layers on glass and dishes and may cause glass corrosion. Continued use of too much detergent may cause machine damage.

Using little detergent can result in poor cleaning and you can see whitish streaks in hard water.

See the detergent manufacturer's instructions for a further information.

4.9. Filling the detergent

Push the latch to open the dispenser and pour in the detergent.

Close the lid and press it until it locks in place. The dispenser should be refilled just before the start of each programme. If the dishes are heavily soiled, place additional detergent in the pre-wash detergent chamber.

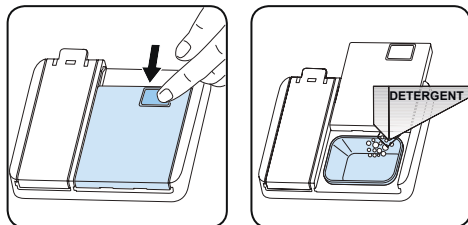

4.10. Using combined detergents

These products should be used according to the manufacturer's instructions.

Never put combined detergents into the interior section or the cutlery basket.

Combined detergents contain not only the detergent but also rinse-aid, salt replacement substances and additional components depending on the combination.

We recommend you do not use combined detergents in short programmes. Please use powder detergents in such programmes.

If you encounter problems when using combined detergents, please contact the detergent manufacturer.

When you stop using combined detergents, make sure that water hardness and rinse aid settings are set to the correct level.

4.11. Rinse-aid usage

The rinse aid helps to dry the dishes without streaks and stains. Rinse-aid is required for stain-free utensils and clear glasses. The

rinse aid is automatically released during the hot rinse phase. If rinse aid dosage setting set too low, whitish stains remains on dishes and dishes do not dry and washed clean.

If rinse aid dosage setting set too height, you can see bluish layers on glass and dishes.

4.12. Filling the rinse-aid and setting

To fill the rinse aid compartment, open the rinse-aid compartment cap. Fill the compartment with rinse aid to the MAX level and then close the cap. Be careful not to overflow the rinse aid compartment and wipe up any spills.

In order to change the rinse aid level, follow the below steps before turning on the machine:

- Push the programme button and hold it down.
- Turn on the machine.
- Hold down the programme button until "rA" disappears from the display. Rinse aid setting follows water hardness setting.
- The machine will display the last setting.
- Set the level by pushing the programme button.
- Switch off the machine to save the setting.
- The factory setting is "4".

If the dishes are not drying properly or are spotted, increase the level. If blue stains form on your dishes, decrease level.

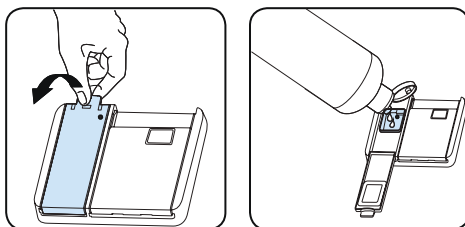

| Level | Brightener Dose | Indicator |
|--------------|-------------------------|-----------------------------|
| 1 | Rinse-aid not dispensed | r1 is shown on the display. |
| 2 | 1 dose is dispensed | r2 is shown on the display. |
| 3 | 2 doses are dispensed | r3 is shown on the display. |
| 4 | 3 doses are dispensed | r4 is shown on the display. |
| 5 | 4 doses are dispensed | r5 is shown on the display. |

5. LOADING YOUR DISHWASHER

For best results, follow these loading guidelines.

Loading the household dishwasher up to the capacity indicated by the manufacturer will contribute to energy and water savings.

Manual pre-rinsing of tableware items leads to increased water and energy consumption and is not recommended. You can place cups, glasses, stemware, small plates, bowls, etc. in upper basket. Do not lean long glasses against one another or they cannot remain steady and may receive damage.

When placing long stem glasses and goblets, lean them against the basket edge or rack and not against other items.

Place all containers such as cups, glasses and pots into the dishwasher with the opening facing downwards otherwise water can collect on items.

If there is cutlery basket in machine, you are recommended to use the cutlery grid in order to obtain the best result. Place all large (pots, pans, lids, plates, bowls etc.) and very dirty items in the lower rack.

Dishes and cutlery should not be placed above each other.

 **WARNING:** Take care not to obstruct the rotation of spray arms.

 **WARNING:** Make sure after loading the dishes do not prevent opening the detergent dispenser.

5.1. Recommendations

Remove any coarse residue on dishes before placing the dishes in the machine. Start the machine with full load.

 Do not overload the drawers or place dishes in the wrong basket.

 **WARNING:** To avoid any possible injuries, place long-handle and sharp-pointed knives with their sharp points facing down or horizontally on the baskets.

SOFT TOUCH

Top basket

Height Adjustable Rack

These racks are designed to increase the capacity of the top basket. You can place your glasses and cups on the racks. You can adjust the height of these racks. Thanks to this feature, you can place different sizes of glasses under these racks.

Thanks to height adjustment plastics mounted on the basket, you can use your racks in 2 different heights. In addition, you can place long forks, knives and spoons on these racks laterally, so that they do not block the revolution of propeller.

The soft touch feature on the racks serves to place the fine stemmed glass.

The wineglass is placed in the area shown at the picture.

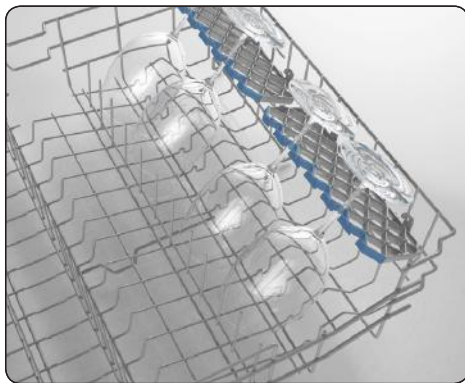

Foldable racks

Foldable racks on the upper basket are designed in order to let you place big items easier such as pots, pans, etc. If requested, each part can be folded separately, or all of them can be folded and larger spaces can be obtained. You can use foldable racks by raising them upwards, or by folding down.

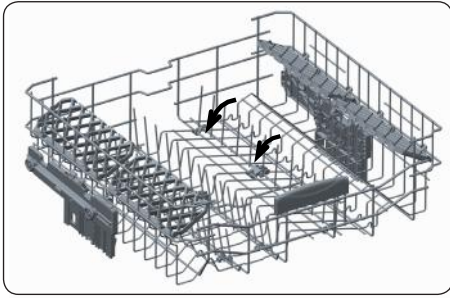

Upper Basket Height adjustment

Turn the Rail Stop Clips, at the ends of the rails, to the sides to open them (as shown in the image below), then pull out and remove the basket. Change the position of the wheels, then reinstall the basket to the rail, making sure to close the Rail Stop Clips. When the upper basket is in the higher position, large items such as pans can be placed on the lower basket.

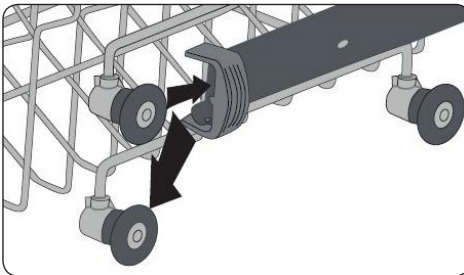
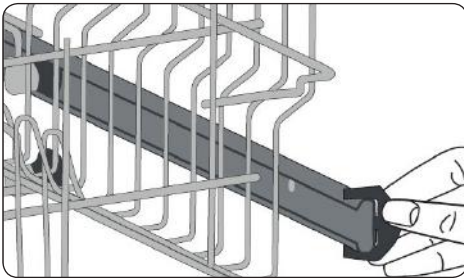

Four Folding Racks

The folding racks are designed so that large items, such as pots and pans, can be easily placed in the dishwasher. Each section can be folded separately. The racks can be folded down or raised up, as shown in the images below.

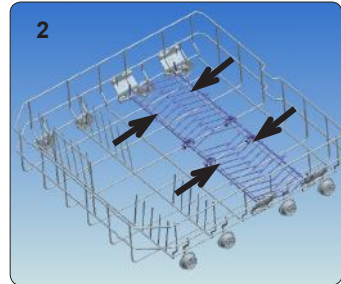
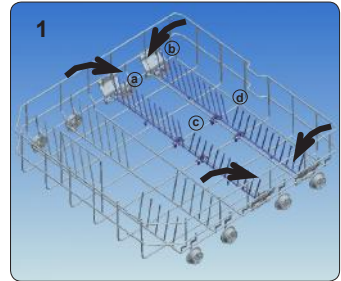

Slide Basket

The movable cutlery basket can slide between the front and rear wires of the bottom basket.



5.2. Alternative basket loads

Lower basket

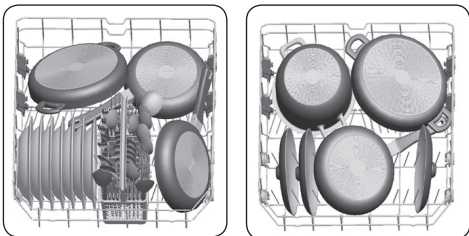

Upper basket

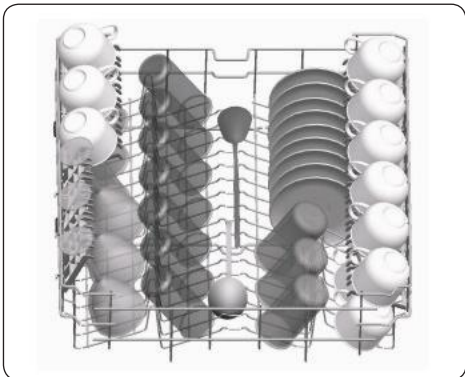

Incorrect Loads

Incorrect loading can cause poor washing and drying performance. Please follow the manufacturer's recommendations for a good performance result.

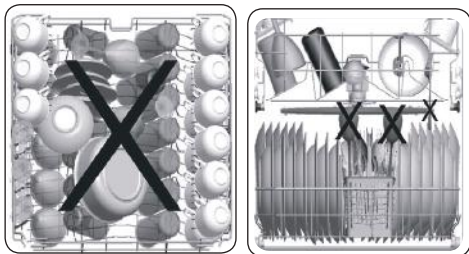

Unsuitable items for dishwashing

- Cigarette ashes, candle leftovers, polish, paint, chemical substances, iron-alloy materials.
- Forks, spoons and knives with wooden, bone, ivory or nacrecoated handles; glued items, items soiled with abrasive, acidic or base chemicals.
- Temperature-sensitive plastics, copper or tincoated containers.
- Aluminium and silver objects.
- Some delicate glasses, ornamental printed porcelains; some crystal items, adhered cutlery, lead crystal glasses, cutting boards, synthetic fibred items.
- Absorbent items such as sponges or kitchen rugs.



IMPORTANT: In future, purchase dishwasher-proof kitchenware.

Important Note for Test Laboratories

For detailed information required for tests according to EN normatives and a softcopy of the manual, please send the model name and serial number to the following address: dishwasher@standardtest.info

6. PROGRAMME TABLE

| | P1 | P2 | P3 | P4 | P5 | P6 | P6 |
|--|--|--|--|---|--|-------------------------------------|---|
| Program Name: | Prewash | Quick 30° 40°C | Delicate 40°C | Eco | Express 50° 65°C | Intensive 65°C | Auto |
| Type of Soil: | Suitable to rinse dishes that you plan to wash later | Suitable for lightly soiled dishes and quick wash. | Suitable for lightly soiled delicate dishes. | Standard program for normally soiled daily using dishes with reduced energy and water consumptions. | Suitable for normally soiled daily dishes with faster program. | Suitable for heavily soiled dishes. | Auto program for heavily soiled dishes. |
| Level of Soil: | Light | Light | Light | Medium | Medium | Heavy | Heavy |
| Amount of Detergent: A: 25 cm ³ B: 15 cm ³ | - | A | A | A | A | A | A |
| Program Duration (h:min) | 00:15 | 00:30 | 01:14 | 03:25 | 00:50 | 01:57 | 01:25 - 01:57 |
| Electricity consumption (kWh/cycle) | 0.020 | 0.740 | 0.880 | 0.937 | 1.100 | 1.700 | 1.450 - 1.700 |
| Water consumption (l/cycle) | 4.5 | 12.4 | 16.0 | 12.0 | 12.0 | 17.2 | 11.9 - 17.2 |

- The program duration may change according to the amount of dishes, the water temperature, the ambient temperature and selected additional functions.
- Values given for programmes other than the eco programme are indicative only
- Eco programme is suitable to clean normally soiled tableware, that for this use, it is the most efficient programme in terms of its combined energy and water consumption, and that it is used to assess compliance with the EU ecodesign legislation.
- Washing tableware in a household dishwasher usually consumes less energy and water in the use phase than hand dishwashing when the household dishwasher is used according to the manufacturer's instructions.
- Only use powder detergent for short programs.
- Short programs do not include drying.
- To assist drying, we recommend slightly opening the door after a cycle is complete.
- You can access the product database where the model information is stored by reading the QR code on the energy label.



NOTE: According to regulations 1016/2010 and 1059/2010, Eco program energy consumption values may differ. This table is in line with regulations 2019/2022 and 2017/2022.

7. THE CONTROL PANEL

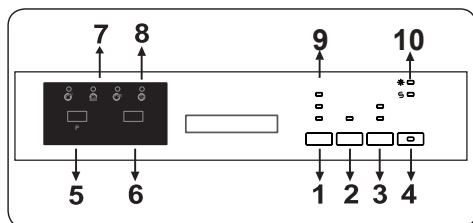

You can press the On/Off button (4) to switch on the product. On/off lights will be lit as long as the machine is on. Press the program button (5) to set the required program.

Press the Start/Pause button (6) to start the program. Once the selected program has started, the washing light will be on and the program duration will be displayed. If you open the door of the machine whilst the program is continuing, program number and program duration will be displayed alternately (7).

You can follow the program flow with the washing, rinsing, drying and end lights (8) on the control panel. Once the drying light has switched on, the machine will remain silent for 40 to 50 minutes.

 **NOTE:** If you press the option button (3) once, half load option will be activated. This option will shorten the durations of the selected programs to reduce power and water consumption. If you are using combined detergents that contain salt, rinse aid and extra features, press the option button for the second time and activate the tablet function. You can use the extra button (1) to add the following functions to the compatible washing program.

If you want to change the delay time, press the Start/Pause button first, and then press the Delay (2) button to select the new delay time. Press Start/Pause button to activate the new delay time. To cancel the delay, press the Delay button until the delay time is 0h.

When the hygiene function is active, you can make the washing process more hygienic by changing the washing temperature and durations of the current program.

If you select the extra rinsing function, the extra rinsing light will switch on and additional rinses will be added to the selected program, making your dishes cleaner and shinier.

If you select the extra drying function, the extra drying light will switch on and the drying duration of the selected program will extend, making your dishes drier.

IMPORTANT: Hygiene and Drying functions cannot be selected at the same time since they are incompatible with each other.

If you have used any extra function in the washing program, the function will still be active in the next washing program. If you want to cancel that function for the newly selected program, press and hold the button of the relevant function until the corresponding lights go off, or press the On/Off button (4) to switch off the machine. If you want to use an extra function for the newly selected program, select the desired functions.

 **NOTE:** If you switch off the machine after selecting the delay time and starting the program, the delay time will be cancelled.

 **NOTE:** You can press the delay button (2) before the program starts to delay the program start time for 1 to 19 hours.

 **NOTE:** Salt refill indicator (10) will light if salt is missing/insufficient. In this case, please fill the salt compartment.

 **NOTE:** Rinse aid refill indicator (10) will light if rinse aid is missing/insufficient. In this case, please fill the rinse aid compartment.

Using the Child Lock

Press "Extra" and "Option" keys simultaneously for 3 seconds to activate Child Lock. At that time, on the remaining time indicator, "CL" is displayed for 2 seconds. To deactivate this function, again, press "Extra" and "Option" keys at the same time for 3 seconds. "CL" will flash twice.

7.1. Changing the Program

When you want to change the program whilst a wash cycle is in progress.

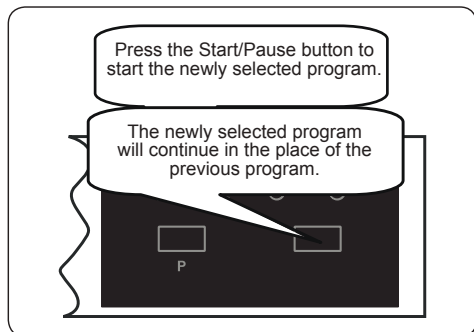
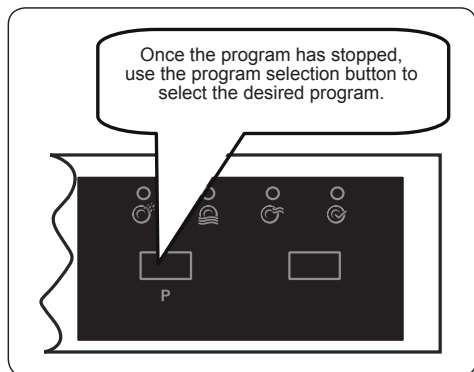
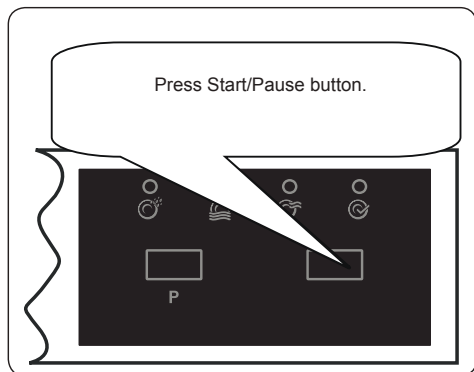

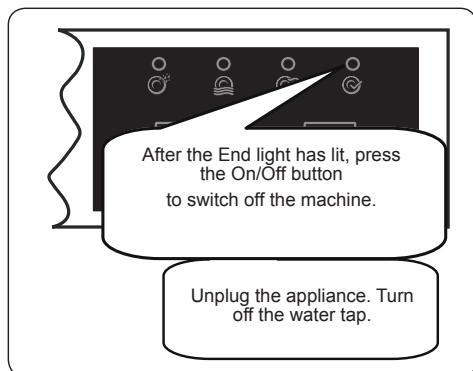
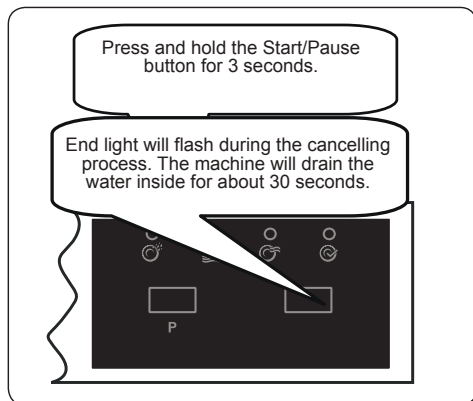

7.2. Cancelling the Program

When you want to cancel the program while a washing cycle is in progress.



 **NOTE:** Do not open the door until the program finishes.

 **NOTE:** At the end of the washing program, you can leave the door of the machine ajar to speed up the drying process.

 **NOTE:** If you open the door of the machine or if power gets cut during the washing cycle, the program will resume once the door has been closed or the power has recovered.

8. CLEANING AND MAINTENANCE

Cleaning your dishwasher is important to maintain the machine's service life. Make sure that the water softening setting (If available) is done correctly and correct amount of detergent is used to prevent limescale accumulation. Refill the salt compartment when the salt sensor light comes on.

Oil and limescale may build up in your Dishwasher over time. If this occurs:

- Fill the detergent compartment but do not load any dishes. Select a programme which runs at high temperature and run the Dishwasher empty. If this does not clean your Dishwasher sufficiently, use a cleaning agent designed for use with dishwashers.
- To extend the life of your dishwasher, clean the appliance regularly on each month
- Wipe the door seals regularly with a damp cloth to remove any accumulated residue or foreign objects.

8.1. Filters

Clean the filters and spray arms at least once a week. If any food waste remains or foreign objects on the coarse and fine filters, remove them and clean them thoroughly with water.

- a) Micro Filter b) Coarse Filter
c) Metal Filter

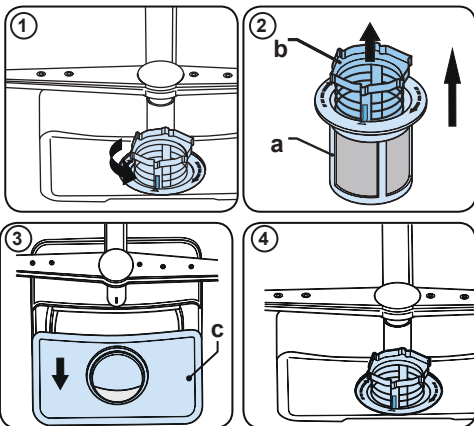

To remove and clean the filter combination, turn it counter clockwise and remove it by lifting it upwards **(1)**. Pull the coarse filter out of the micro filter **(2)**. Then pull and remove the metal filter **(3)**. Rinse the filter with lots of water until it is free of residue. Reassemble the filters. Replace the filter insert, and rotate it clockwise **(4)**.

- Never use your dishwasher without a filter.
- Incorrect fitting of the filter will reduce the washing effectiveness.
- Clean filters are necessary for proper running of the machine.

8.2. Spray arms

Make sure that the spray holes are not clogged and that no food waste or foreign object is stuck to the spray arms. If there is any clogging, remove the spray arms and clean them under water. To remove the upper spray arm undo the nut holding it in position by turning it clockwise and pulling it downwards. Make sure that the nut is properly tightened when refitting the upper spray arm.

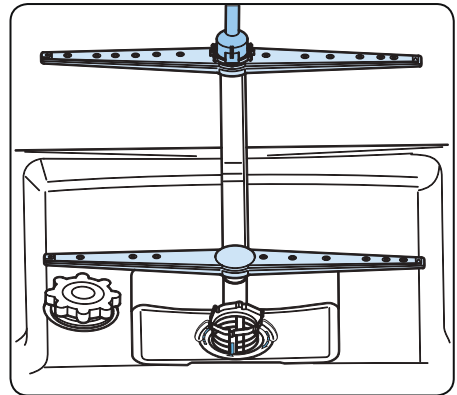

8.3 Drain Pump

Large food residues or foreign objects which were not captured by the filters may block the waste water pump. The rinsing water will then be above the filter.

 Warning Risk of cuts!

When cleaning the waste water pump, ensure that you do not injure yourself on pieces of broken glass or pointed implements.

In this case:

1. First always disconnect the appliance from the power supply.
2. Take out baskets.
3. Remove the filters.
4. Scoop out water, use a sponge if required.
5. Check the area and remove any foreign objects.
6. Install filters.
7. Re-insert baskets.

AUTOMATIC SHOOTING WARNINGS AND WHAT TO DO

| TROUBLE CODE | POSSIBLE FAULT | WHAT TO DO |
|--------------|------------------------------|--|
| F5 | Insufficient water | Make sure the water inlet tap is open and water is flowing |
| | | Separate the inlet hose from the tap and clean the filter of the hose. |
| | | Contact for service if the error continues. |
| F3 | Continuous water input | Close the tap and contact for service. |
| F2 | Inability to discharge water | Water discharge hose and filters may be clogged. |
| | | Cancel the program. |
| | | If the error continues, contact for service. |
| F8 | Heater error | Contact for service. |
| F1 | Overflow | Unplug the machine and close the tap. |
| | | Contact for service. |
| FE | Faulty electronic card | Contact for service. |
| F7 | Overheating | Contact for service. |
| F9 | Divisor position error | Contact for service. |
| F6 | Faulty heater sensor | Contact for service. |

The installation and repairing procedures should always be carried out by the Authorised Service Agent in order to avoid possible risks. The manufacturer shall not be held liable for damages that may arise from procedures carried out by unauthorised persons. Repairs may be carried out by technicians only. If a component has to be replaced, ensure that only original spare parts are used.

Improper repairs or use of non-original spare parts may cause considerable damage and put the user at considerable risk.

Contact information for your customer service can be found on the back of this document.

Function-relevant genuine spare parts according to the corresponding Ecodesign order can be obtained from Customer Service for a period of at least 10 years from the date on which your appliance was placed on the market within the European Economic Area.

| FAULT | POSSIBLE CAUSE | TROUBLESHOOTING |
|---|---|--|
| Whitish stains remains on dishes. | Not enough detergent used. | Use the correct amount of detergent, as instructed in the programme table. |
| | Rinse aid dosage and/or water softener setting set too low. | Increase rinse aid and/or water softener level. |
| | High water hardness level. | Increase water softener level and add salt. |
| | Salt compartment cap not closed properly. | Check that the salt compartment cap is closed properly. |
| Dishes do not dry. | Drying option is not selected. | Select a programme with a drying option. |
| | Rinse aid dosage set too low. | Increase rinse aid dosage setting. |
| Rust stains form on the dishes. | Stainless-steel quality of the dishes is insufficient. | Use only dishwasher-proof sets. |
| | High level of salt in wash water. | Adjust the water hardness level using water hardness table. |
| | Salt compartment cap not closed properly. | Check that the salt compartment cap is closed properly. |
| | Too much salt spilled in the Dishwasher while filling it with salt. | Use funnel while filling salt to the compartment to avoid spillage. |
| | A poor mains grounding. | Consult a qualified electrician immediately. |
| Detergent remains in the detergent compartment. | Detergent was added when the detergent compartment was wet. | Make sure detergent compartment is dry before use. |

AUTOMATIC FAULT WARNINGS AND WHAT TO DO

| TROUBLE CODE | POSSIBLE FAULT | WHAT TO DO |
|--------------|------------------------------|--|
| F5 | Insufficient water | Make sure the water inlet tap is open and water is flowing. |
| | | Separate the inlet hose from the tap and clean the filter of the hose. |
| | | Contact for service if the error continues. |
| F3 | Continuous water input | Close the tap and contact for service. |
| F2 | Inability to discharge water | Water discharge hose and filters may be clogged. |
| | | Cancel the program. |
| | | If the error continues, contact for service. |
| F8 | Faulty heater | Contact for service. |
| F1 | Overflow | Unplug the machine and close the tap. |
| | | Contact for service. |
| F7 | Overheating failure | Contact for service. |
| F6 | Faulty temperature sensor | Contact for service. |
| FE | Faulty electronic card | Contact for service. |

The installation and repairing procedures should always be carried out by the Authorised Service Agent in order to avoid possible risks. The manufacturer shall not be held liable for damages that may arise from procedures carried out by unauthorised persons. Repairs may be carried out by technicians only. If a component has to be replaced, ensure that only original spare parts are used.

Improper repairs or use of non-original spare parts may cause considerable damage and put the user at considerable risk.

Contact information for your customer service can be found on the back of this document.

Function-relevant genuine spare parts according to the corresponding Ecodesign order can be obtained from Customer Service for a period of at least 10 years from the date on which your appliance was placed on the market within the European Economic Area.

10. PRACTICAL INFORMATION

1. When the machine isn't in operation:
 - Disconnect the plug and close the tap.
 - Leave the door slightly open to prevent odour formation.
2. Select the dry option to remove water droplets.
3. Place dishes in the machine properly to achieve the best energy consumption, washing and drying performance. Please see the programme and consumption table for more information.
4. Rinse dirty dishes before placing them in the dishwasher.
5. Only use the Prewash programme when necessary.
6. Do not place the machine near a refrigerator because it will reach high temperatures.
7. If the machine is located in an area that is at risk of freezing, close the tap, disconnect the inlet hose from the tap and drain the water inside the hose and the machine completely.



Service & Support

Visit Our Website
sharphomeappliances.com

SHARP

Be Original.

52306969 R60