

SHARP

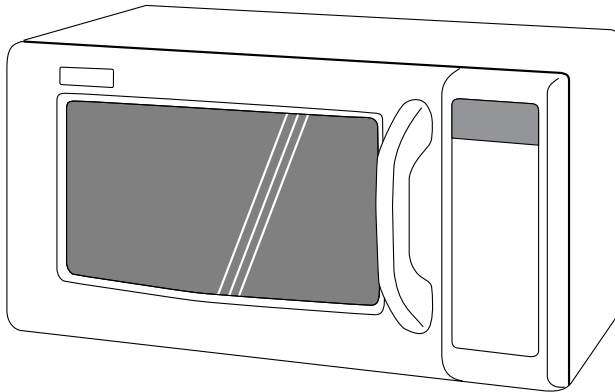

Model

—— **R-21ATP** ——

COMMERCIAL MICROWAVE OVEN OPERATION MANUAL

Original Instruction

This operation manual contains important information which you should read carefully before using your microwave oven.

IMPORTANT: There may be a serious risk to health if this operation manual is not followed or if the oven is modified so that it operates with the door open.

INTELLIGENT THINKING

C ONTENTS

○ Contents	1
○ Oven Diagram	2
○ Control Panel	3
○ Important Safety Instructions	4
○ Installation	5
○ Before Operation	6
○ How to Operate the Oven:	
Memory Cooking:	
Note for memory cooking	7
Cooking with memory	7
Cooking double quantity with memory	8
Memory programme entry	8
Memory check	11
Manual Cooking:	
Note for manual cooking	12
Manual cooking	12
Sequence programming	13
Other Convenient Features:	
Express defrost	14
Counter check	15
Counter clear	15
Demonstration mode	16
Information with error message	16
○ Cooking Advice:	
Suitable Cookware	17
Food Handling & Preparation	18
Advice for Defrosting	19
Advice for Reheating	20
○ Charts:	
Defrosting Chart	21 - 22
Cooking Chart	23 - 25
Reheating Chart	26 - 30
○ Cleaning & Maintenance	31
○ Troubleshooting	32
○ To Replace the Mains Plug	33
○ Calling for Service	33
○ Specifications	34

OVEN DIAGRAM

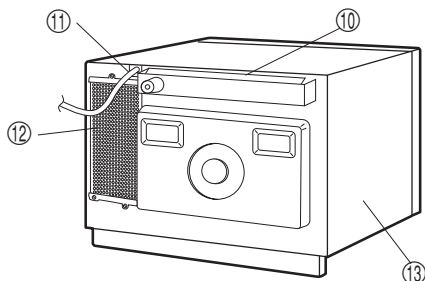
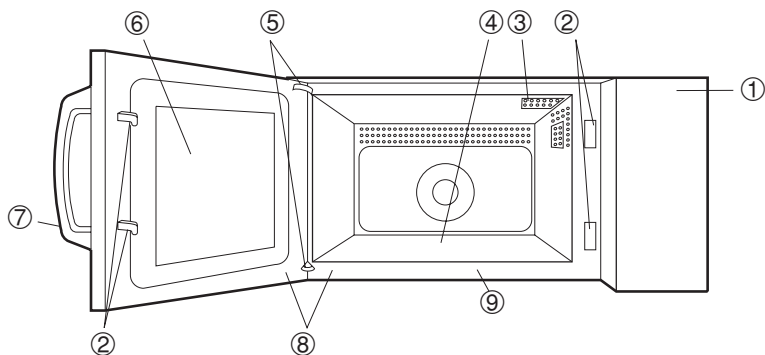

1. Touch control panel
2. Door safety latches
3. Oven lamp
4. Ceramic floor
(Not removable)
5. Door hinges
6. Oven door with see - through window
7. Door handle
8. Door seals and sealing surfaces
9. Cavity face plate
10. Air ventilation cover and openings
11. Power supply cord
12. Air intake filter (Air intake openings)
13. Outer case cabinet

ACCESSORIES:

Check to make sure the following accessories are supplied:

- Operation manual
- Menu sticker
Enter cooking times or dish names in this sticker and attach to the control panel.
- Caution sheet (Special Instructions and Warnings)

C ONTROL PANEL

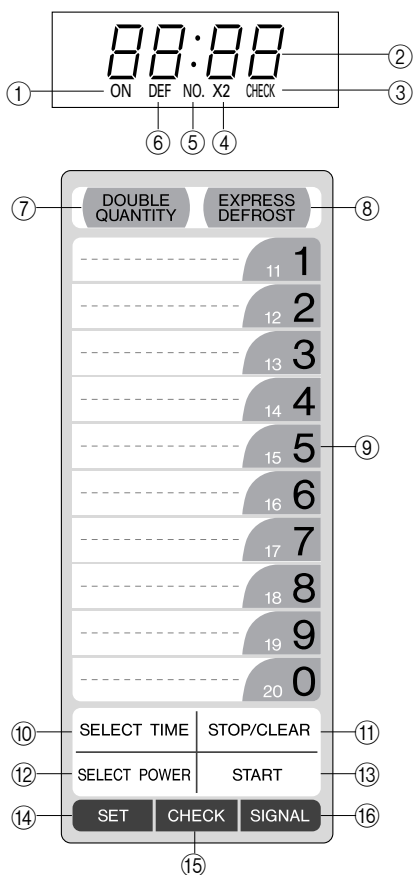

DISPLAY AND INDICATORS

- ① Heating indicator:
This indicator shows heating in progress
- ② Digital display
- ③ Check mode indicator
- ④ Double quantity mode indicator
- ⑤ Memory number indicator
- ⑥ EXPRESS DEFROST indicator

OPERATING PADS

- ⑦ DOUBLE QUANTITY pad
- ⑧ EXPRESS DEFROST pad
- ⑨ NUMBER pads for time and memory programming
- ⑩ SELECT TIME pad
- ⑪ STOP/CLEAR pad; press to stop operation of oven and clear remaining heating time
- ⑫ SELECT POWER pad for setting variable power level
- ⑬ START pad; press to operate oven after door is closed and time is set
- ⑭ SET pad for setting memory
- ⑮ CHECK pad for checking memory
- ⑯ SIGNAL pad for setting signal sound

I

IMPORTANT SAFETY INSTRUCTIONS

IMPORTANT: PLEASE READ CAREFULLY AND KEEP FOR FUTURE REFERENCE.

This appliance is intended to be used by expert or trained user in shops, in light industry and on farms, or for commercial use by lay persons.

This oven is designed to be used on a countertop only. It is not designed to be built into a kitchen unit. Do not place the oven in a cabinet.

The electrical outlet must be readily accessible so that the unit can be unplugged easily in an emergency.

If smoke or burn is observed: Keep the oven door closed and switch off the power by disconnecting the plug from the socket in order to stifle any flames. Failure to follow this procedure may result in fire and oven damage.

Ensure there is a minimum of free space above the oven of 15 cm.

This appliance is not intended for use by persons (including children) with reduced physical, sensory or mental capabilities, or lack of experience and knowledge, unless they have been given supervision or instruction concerning use of the appliance by a person responsible for their safety.

Children should be supervised to ensure that they do not play with the appliance.

WARNING: Only allow children to use the oven without supervision when adequate instructions have been given so that the child is able to use the oven in a safe way and understands the hazards of improper use.

WARNING: If the door or door seals are damaged, the oven must not be operated until it has been repaired by a competent person.

WARNING: Never adjust, repair or modify the oven yourself. It is hazardous for anyone other than a competent person to carry out any service or repair operation which involves the removal of a cover which gives protection against exposure to microwave energy.

If the power supply cord of this appliance is damaged, it must be replaced by an authorised SHARP service agent in order to avoid a hazard.

WARNING: Liquids and other foods must not be heated in sealed containers since they are liable to explode.

WARNING: Microwave heating of beverages can result in delayed eruptive boiling, therefore care must be taken when handling the container.

Do not cook eggs in their shells, and whole hard boiled eggs should not be heated in microwave ovens since they may explode even after microwave cooking has ended. To cook or reheat eggs which have not been scrambled or mixed, pierce the yolks and the whites, or the eggs may explode. Shell and slice hard boiled eggs before reheating them in the microwave oven. Utensils should be checked to ensure that they are suitable for use in the oven. See page 17-18. Use only microwave safe containers and utensils on microwave modes.

WARNING: The contents of feeding bottles and baby food jars must be stirred or shaken and the temperature checked before consumption, in order to avoid burns.

When heating food in plastic or paper containers, keep an eye on the oven due to the possibility of ignition.

Clean the oven at regular intervals and remove any food deposits.

Failure to maintain the oven in a clean condition could lead to deterioration of the surface that could adversely affect the life of the appliance and possibly result in a hazardous situation.

See instructions for cleaning door seals, cavities and adjacent parts on page 31.

The oven should not be cleaned with a water jet.

Use oven gloves when removing food from the oven to prevent burns.

The microwave oven should not be left unattended during operation. Power levels that are too high, or cooking times that are too long, may overheat foods resulting in a fire.

A separate circuit serving only this appliance should be provided.

Oven Use:

- The oven is for food preparation only. Never operate when empty.
- Do not leave or store anything inside the oven when not in use.
- Never attempt to use the oven with the door open. It is important not to tamper with the door safety latches. This may result in exposure to microwave energy.
- Never operate the oven with any object caught in the door sealing surfaces, this again may cause microwave leakage.
- Do not insert fingers or objects in the holes of the door latches or air vent openings as this may damage the oven and cause an electric shock.
- If water or food drops inside the air vent openings switch off the oven immediately, unplug it and call a Service Technician appointed by SHARP.
- Never attempt to move the oven while it is operating.
- Do not use the oven near a steamer or a fryer.
- Always wipe up spills on the ceramic floor and splashes on the walls after cooking. If you leave grease on the ceramic floor and walls it may overheat, smoke or even catch fire when next using your oven.
- **Pacemaker:** If you have a heart pacemaker, consult your doctor or the pacemaker manufacturer prior to oven use.
- **Liquids:** Microwave heating of beverages can result in delayed eruptive boiling, therefore care must be taken when handling the container. Stir the liquid prior to and during heating/ reheating, let liquid stand for at least 20 seconds in the oven after cooking.

I NSTALLATION

WARNING:

Inspect the Oven:

Check the oven carefully for damage before and regularly after installation.

- Make sure the door closes properly, that it is not misaligned or warped.
- Check the hinges and door safety latches are not broken or loose.
- Ensure the door seal and sealing surfaces are not damaged.
- Inspect the oven interior and door for dents.

Caution Sheet:

Always keep the caution sheet (Special Instructions and Warnings) close to the oven for your reference.

Important:

If any damage is apparent, do not operate the oven in any way. Contact your dealer or an authorised Service Technician appointed by SHARP.

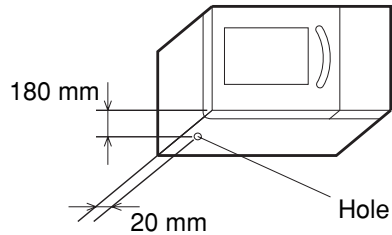

- 9 This oven is not intended to stack one on top of another.

BUILDING-IN-KIT

This oven is not designed to be built into a kitchen unit.

IMPORTANT! ELECTRICAL CONNECTION

- Do not allow water to come into contact with the power supply cord or plug.
- Insert the plug properly into the socket as the plug may otherwise overheat and catch fire.
- Do not connect other appliances to the same socket using an adaptor plug as it may cause the wiring to overheat and catch fire.
- If the plug or socket is loose or the power supply cord is damaged, do not operate the oven, it must be replaced by the special power cord. Contact your dealer or a Service Technician appointed by SHARP. A defective plug, power supply cord or socket may overheat and catch fire during operation or cause an electrical shock.
- When removing the plug from the socket always grip the plug, never the mains lead as this may damage the power supply cord and the connections inside the plug.
- The product is fitted with a non-rewireable (moulded) plug. Should it not be suitable for the socket outlet in your kitchen, remove the plug and fit an appropriate type, observing the wiring code given in "To replace the mains plug" on page 33.

The fuse from a cut-off plug should be removed and the plug disposed of in safe manner. Under no circumstances should the cut-off plug be inserted into a socket outlet as serious electrical shock may occur. The plug must not be used without the fuse cover fitted.

When replacing the plug please ensure that you use a BSI or ASTA approved plug to BS1363, this should be fitted with a brown coloured 13 amp fuse approved by BSI or ASTA to BS1362. If you have any doubt about electrical connection seek the help of a qualified electrician.

WARNING

THIS APPLIANCE MUST BE EARTHED.

To wire an appropriate plug, follow the wiring code given in "To replace the mains plug" on page 33.

- 1 Remove all packing materials. Remove the protective film (blue film) from the outer case cabinet (if covered). Do not remove the plastic film from the inside of the oven window as this protects it from dirt.
- 2 Place oven on a secure, level surface, strong enough to take the oven weight, plus the heaviest item likely to be cooked in the oven.
Do not place this oven in a position which is not easily accessible. To position the oven too high can be dangerous because food can not be removed safely.
- 3 Ensure there is a minimum free space above the oven of 15 cm.
- 4 Do not place the oven where heat, moisture or high humidity are generated, (for example, near or above a conventional oven) or near combustible materials (for example, curtains). Do not block or obstruct air vent openings, as obstructions may ignite due to the emission of hot air.
- 5 Make sure the power supply cord is undamaged and that it does not run under the oven or over any hot or sharp surfaces.
- 6 The socket must be readily accessible so that it can be easily unplugged in an emergency.
- 7 Do not use the oven outdoors.
- 8 The unit may be secured to a countertop or stand. There is a screw hole in the bottom of the unit. After the oven is permanently placed, drill a hole through the counter top for a 5 mm self-tapping screw. The hole should be 20 mm from the left side of the outer case cabinet and 180 mm back from the front edge of the cavity face plate.

B

BEFORE OPERATION

The operation of the oven is controlled by pressing the appropriate pads on the control panel. A signal should be heard each time you press the control panel.

- When you first connect the microwave oven to an electrical socket, the digital display will show .
- Key pad entries can only be made when the door is closed.
- The programme or check mode is cancelled when any pads are not pressed for more than 3 minutes.
- End will appear on the display after the time reaches zero. It will disappear when the oven door is opened or the STOP/CLEAR pad is pressed.

SOUND SETTING

- There is a choice of 2 different sounds or no sound on your oven.
- To set a signal, touch the SET pad twice within 2 seconds and then touch the SIGNAL pad continuously until you hear the tone required.

STOPPING THE OVEN

- If you want to stop the oven during cooking, press the STOP/CLEAR pad once or open the door (except memory cooking).
To start the oven again, close the door and press the START pad within 1 minute.
- If you open the door during memory cooking, the programme is cancelled.
- If you want to cancel a programme during cooking, press the STOP/CLEAR pad twice.
- If you want to clear a mistake during programming, press the STOP/CLEAR pad once.

H OW TO OPERATE THE OVEN

Introduction: Water, sugar and fat in food absorbs microwaves and causes their molecules to vibrate. This creates heat by friction, in the same way your hands get warm when you rub them together.

The outer areas of food are heated by microwave energy and the remaining portions by conduction. It is important to **turn, rearrange or stir** food to ensure even heating. Where recommended, allow food to stand, this is not optional but is **necessary** to ensure thorough cooking. It is particularly important for dense food, such as joints of meat.

NOTES:

- Microwaves pass through non-metallic dishes and utensils and heat the food inside the dishes.
- Microwaves are reflected by metal.
- The oven is lined with metal and has a fine metallic mesh in the door to prevent microwave leakage.
- Metallic dishes are not suitable for microwaving.

MEMORY COOKING

NOTE FOR MEMORY COOKING

- This oven has 20 memory banks (1-20) which can store cooking programmes.
- The memory banks 1-0 have been programmed previously as shown in the table. These pre-programmed memory banks can be changed individually if required.
- In addition for all memory banks a time constant 1.7 for the double quantity is stored. The stored time constant can also be changed individually if required.
- Information in these memory banks is not lost due to power interruptions. If the power goes off, the oven does not need to be reprogrammed. No batteries are necessary for this type of memory.
- If you want to memorise or check the programme or cook using memory 11-20, press the desired NUMBER pad twice within 1 second.



Memory No.	Cook Time	Output Power
1	10 sec.	100%
2	20 sec.	100%
3	30 sec.	100%
4	45 sec.	100%
5	1 min.	100%
6	1 min. 15 sec.	100%
7	1 min. 30 sec.	100%
8	2 min.	100%
9	2 min. 30 sec.	100%
0	3 min.	100%

To check the stored programmes please refer to "Memory check" on page 11.

To change the stored programmes please refer to "Memory programme entry" on page 8.



COOKING WITH MEMORY

Example: If you want to cook by using memory 1, which was programmed for 10 seconds at 100%.

Step	Procedure	Pad Order	Display
1	Press the NUMBER pad  .		<div style="border: 1px solid black; padding: 5px; text-align: center;"> NO. 1 </div> <p>After about 1 sec.</p> <div style="border: 1px solid black; padding: 5px; text-align: center;"> ON . 10 </div>

COOKING DOUBLE QUANTITY WITH MEMORY

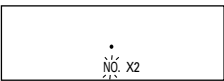
Example: If you want to cook a double quantity using memory 1.

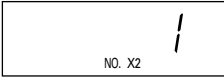
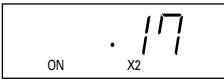
Step	Procedure	Pad Order	Display
1	Press the DOUBLE QUANTITY pad.		 NO. will flash on and off.
2	Press the NUMBER pad  .		 After about 1 sec. 

- Note:
1. If the cooking time of double quantity is over the max. time, the display will show "EE9". See page 16.
 2. Double quantity means best time for cooking double quantity; it is not double the time.
 3. The "MEMORY" cooking system does not require the use of the START pad. MEMORY cannot be used to start the oven if any programme is displayed.

MEMORY PROGRAMME ENTRY

You can change the memory programmes for all memory banks.

The cooking stages you can input are :

Memory NO. 1-10 Max.3 stages
Memory NO.11-20 Max.2 stages

Microwave power level 0~100%

Cooking time Max. 30 minutes for each stage.
 And total cooking time is max.30 minutes.

COOKING GUIDE AND POWER LEVEL











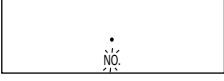

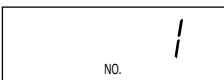

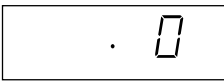



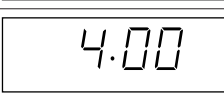
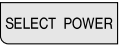
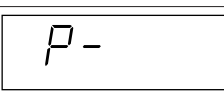

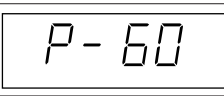
Use the correct NUMBER pad after pressing the SELECT POWER pad.

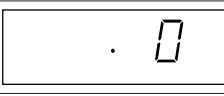
The following chart gives examples of foods typically cooked on microwave power levels.

Number Pads	Microwave Power Levels	Display	Examples of Foods
SELECT POWER	100%	P-HI	Beverage, Fruit, Vegetables, Rice/Pasta
9	90%	P-90	
8	80%	P-80	
7	70%	P-70	Seafood, Cakes, Muffins, Slices, Casseroles, Lasagne
6	60%	P-60	
5	50%	P-50	
4	40%	P-40	
3	30%	P-30	Defrosting, Softening butter
2	20%	P-20	
1	10%	P-10	Keeping food warm
0	0%	P- 0	No microwave power

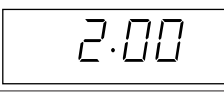
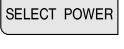
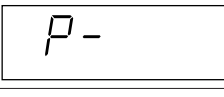
TO PROGRAMME TIME AND POWER LEVEL INTO A MEMORY

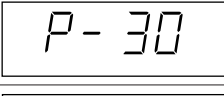
Example: If you want to set 4 minutes on 60% for the 1st sequence and 2 minutes on 30% for the 2nd sequence for 1 serving in memory 1.

Step	Procedure	Pad Order	Display
1	Press the SET pad twice within 2 seconds.	 X 2	 NO. will flash on and off.
2	Press the NUMBER pad  .		
3	Press the SELECT TIME pad.		
4	Enter desired cooking time for the 1st sequence. (4 minutes)	  	
5	Press the SELECT POWER pad.		
6	Enter desired power level for the 1st sequence. (60%)		
7	Press the SELECT TIME pad.		
8	Enter desired cooking time for the 2nd sequence. (2 minutes)	  	
9	Press the SELECT POWER pad.		
10	Enter desired power level for the 2nd sequence. (30%)		
11	Press the SET pad twice to complete the setting.	 X 2	

Note: 1. If the cooking time is over the max. time, the display will show "EE9". See page 16.

2. If your programmed time is over max. time at Double Quantity, you cannot use Double Quantity for the memory. You can cook only 1 serving.











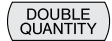
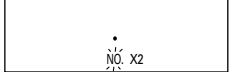

3. It is not necessary to press the SELECT POWER pad for 100%.

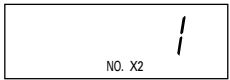
4. At step 1 the audible signal will only sound on the second press of the SET button.

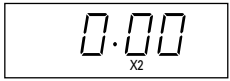
TO CHANGE THE TIME CONSTANT FOR DOUBLE QUANTITY

The time constant for double quantity is preset 1.7 times the single quantity cooking time, but you can alter this constant to suit your needs.

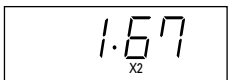
Example: If you want to change the time constant to 1.67 in memory 1.

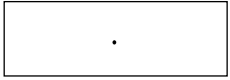
Step	Procedure	Pad Order	Display
1	Press the SET pad twice within 2 seconds.	 X 2	 NO. will flash on and off.
2	Press the DOUBLE QUANTITY pad.		
3	Press the NUMBER pad  .		
4	Press the SELECT TIME pad.		
5	Set the time constant (1.67).	  	
6	Press the SET pad twice to complete the setting.	 X 2	



- Note:
1. In case you want to change the time constant it must be set for each key separately.
 2. The time constant can be set from 0.00 to 9.99.
 3. At step 1 the audible signal will only sound on the second press of the SET button.

MEMORY CHECK

You can check the information programmed into the memory.

CHECKING TIME AND POWER LEVEL

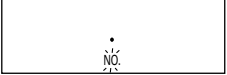
Example: If you want to know the information programmed into the memory 1, memory 1 has been programmed for 4 minutes on 60% for the 1st sequence and 2 minutes on 30% for the 2nd sequence.

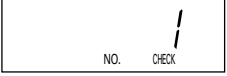
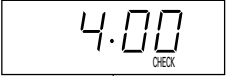
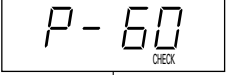
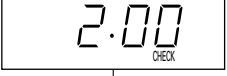
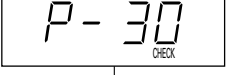
Step	Procedure	Pad Order	Display
1	Press the CHECK pad.		 NO. will flash on and off.
2	Press the NUMBER pad  .		 After about 1 sec.     REPEAT

- Note:
1. To cancel MEMORY CHECK, press the CHECK pad.
 2. When  is displayed at Step 1, the memory is not set.
 3. To check the time constant for double quantity, press the DOUBLE QUANTITY pad and the desired NUMBER pad in step 2.

MANUAL COOKING







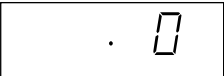

Your oven can be programmed for up to 3 cooking sequences and has 11 preset microwave power levels. See page 8. You can enter cooking time up to 30 minutes for each stage. The total cooking time is 30 minutes maximum.

NOTE FOR MANUAL COOKING

1. It is not necessary to press SELECT POWER pad for 100%.
2. If the cooking time is over the max. time, the display will show "EE9". See page 16.
3. During cooking mode, the oven stops when the door is opened, and the programme is cancelled if the START key is not pressed within 1 minute after the door is closed.

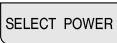
MANUAL COOKING

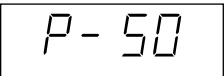

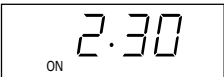





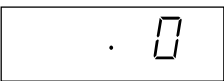

Example: Suppose you want to cook for 2 minutes and 30 seconds at 50%.

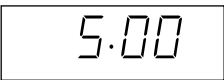
Step	Procedure	Pad Order	Display
1	Press the SELECT TIME pad.		
2	Enter desired cooking time. (2 minutes 30 seconds)	  	
3	Press the SELECT POWER pad.		
4	Enter desired power level. (50%)		
5	Press the START pad.		

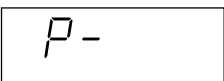
SEQUENCE PROGRAMMING

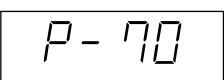
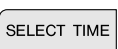
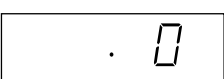
This facility enables continued and uninterrupted operation of up to three different sequences.

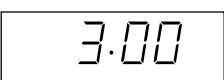
Example: If you want to cook for 5 minutes on 70% followed by 3 minutes on 100%

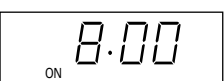
Step	Procedure	Pad Order	Display
1	Press the SELECT TIME pad.		
2	Enter desired cooking time for the 1st sequence.(5 minutes)		
3	Press the SELECT POWER pad.		
4	Enter desired power level for the 1st sequence.(70%)		
5	Press the SELECT TIME pad.		
6	Enter desired cooking time for the 2nd sequence.(3 minutes)		
7	Press the START pad.		









Note: If you want to programme 3 cooking sequences, repeat step 1-4 after step 6.

OTHER CONVENIENT FEATURES

EXPRESS DEFROST

Express Defrost is used to defrost meat and poultry. Enter desired defrost time, referring to the defrost chart.

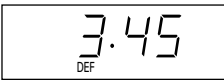
Example: If you want to defrost for 7 minutes and 30 seconds.

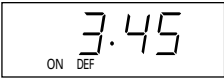
Step	Procedure	Pad Order	Display
1	Press the EXPRESS DEFROST pad.		
2	Enter desired defrost time.		
3	Press the START pad.		
4	Halfway through defrost time CHECK will flash and the oven will "beep" 4 times. Open the door. Turn food over and shield any warm portions. Close the door.		
5	Press the START pad within 1 minute after closing the door.		

Note: If you do not open the door when an audible signal sounds, the defrosting cycle will continue and the defrosting time will count down to 0.

EXPRESS DEFROST CHART

This is specially designed for smaller cuts of food. The following foods should be used on the express defrost programme.

1. Beef Steak
2. Lamb Chops
3. Pork Chops
4. Chicken Portions
5. Fish Steaks

The oven is pre-programmed with a time and power level cycle so that the food listed above is defrosted easily.

BASIC IDEAS FOR EXPRESS DEFROST



- i/ Always allow food to stand for approx. 10-30 minutes after defrosting to equalise the temperature and to produce better defrosting results.
- ii/ Check food after standing. If the item is not thoroughly defrosted, continue to defrost on 20% power for additional time.
- iii/ Choose foods that are the same thickness throughout. This will produce better defrosting results. Foods which vary in thickness may require shielding with small flat pieces of tin foil to prevent over-defrosting.
- iv/ For foods not listed in the chart refer to the manual defrosting chart.
- v/ When freezing chicken pieces, steak, chops and fish, freeze separately in single flat layers and if necessary interleave with freezer plastic to separate layers. This will ensure even defrosting.

FOOD	METHOD	TIME PER 450g / 1lb
Steak Pork, lamb chops Chicken Portions	<ol style="list-style-type: none"> 1. Position the food with thinner parts in centre in a single layer, if pieces are stuck together separate as soon as possible. 2. Turn over, rearrange after the audible sound. <p>After defrosting stand for 10-30 minutes.</p>	5 mins
Fish Steaks	<ol style="list-style-type: none"> 1. Position the food in a single layer. 2. Shield any thinner parts with foil if necessary. 3. If pieces are stuck together separate as soon as possible. 4. Turn over, rearrange after the audible sound. 5. After defrosting allow to stand for 30 mins. 	5 mins

COUNTER CHECK

Set the counters to "0" before using your new oven (see COUNTER CLEAR below) to keep a record of the ovens use.

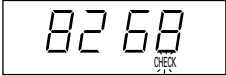
Example: If you want to know the total amount of times the oven has been used, and the number of times each programme has been used. In the following example, the total time was 8268 and memory 1 was 513.

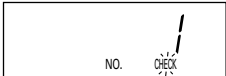
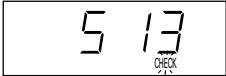
Step	Procedure	Pad Order	Display
1	Press the CHECK pad twice.	 X 2	 CHECK will flash on and off. (Total times used)
2	To check memory 1 usage, press the NUMBER pad  .		 After about 1 sec.  (Times memory 1 was used)

Note: 1. To cancel Counter Check mode, press the CHECK pad.







Each counter can count the times up to 9999, and it will return to 0 if it is over 9999.

2. To check the times of manual cooking, press the SELECT TIME pad at Step 2 instead of the NUMBER pad.
 To check the times of EXPRESS DEFROST cooking, press the EXPRESS DEFROST pad at Step 2 instead of the NUMBER pad.

COUNTER CLEAR

Each number of times can be cleared.

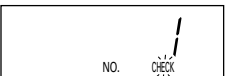
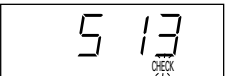
Example: Suppose you want to clear the times of memory 1.

Step	Procedure	Pad Order	Display
1	Press the CHECK pad twice.	 X 2	 CHECK will flash on and off. (Total times used)
2	Press the NUMBER pad  .		 After about 1 sec.  (Times memory 1 was used)
3	Press the SET pad.		

Note: 1. To cancel Counter clear mode, press the CHECK pad.

2. To clear the times of manual cooking, press the SELECT TIME pad at Step 2 instead of the NUMBER pad.
 To clear the times of EXPRESS DEFROST cooking, press the EXPRESS DEFROST pad at Step 2 instead of the NUMBER pad.
3. To clear total using times, skip Step 2.

DEMONSTRATION MODE

To demonstrate, touch SELECT TIME, 0 and then touch START and hold for 3 seconds. **SH0** will appear in the display. Cooking operations can now be demonstrated with no power in the oven. The timer will count down rapidly.

To cancel, touch SELECT TIME, then 0 and STOP/ CLEAR.

INFORMATION WITH ERROR MESSAGE

If ERROR message is displayed, follow the instructions below.

ERROR MESSAGE	
EE9	Cooking time exceeds the max. time. Press the STOP/CLEAR pad and programme again.

C OOKING ADVICE

WARNING - Always attend the oven when in use.









Carefully follow the SHARP Operation Manual at all times. If you exceed recommended cooking times and/or use power levels that are too high, food may overheat, burn, and in extreme circumstances, catch fire and damage the oven.

- The microwave power level will default to 100% unless you press the **SELECT POWER** pad to reach the desired setting. Take care when heating foods with high sugar or fat content, e.g. Christmas pudding, mince pies and fruit cakes. Before use, check that utensils are suitable for use in microwave ovens.
- **Lids:** Always remove lids from food jars and containers before using them in the oven. If you do not, steam and pressure will build up inside and the container may explode. Take care when heating contents in babies bottles, see page 18.
- Do not cook eggs in their shell as they will explode. Do not heat canned potatoes in the microwave oven as they may burst.

For microwaving, use only those utensils suitable for microwave cookery as indicated below.

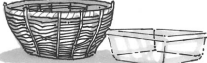
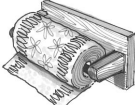
A variety of cookware can be used for microwaving. Round/oval dishes rather than square/oblong ones are recommended, as food in the corners tends to overcook.

SUITABLE COOKWARE

COOKWARE	SUITABLE FOR MICROWAVING
Heat resistant glass, (e.g. Pyrex®, Fire King®, Corning Ware®). 	YES
Microwave-safe plastic cookware. 	YES
Microwave cling film , microwave roasting bags. 	YES Microwave cling film and bags must be vented for steam to escape, pierce in 4-5 places. Do not use plastic or metal ties as they may melt or catch fire due to 'arcing'.
Heat resistant china and ceramics. 	YES Except for dishes with metallic decoration.
Disposable containers: Thin plastic, paper, straw and wooden containers. 	YES Always attend the oven closely. Only use for warming food. Pay special attention as over-heating may cause a fire in your oven. NOTE: When heating food in plastic or paper containers, monitor the oven due to the possibility of ignition.
Kitchen paper. 	YES Always attend the oven closely. Only use to absorb fat and moisture when warming food. Pay special attention as overheating may cause a fire in your oven.
Browning dishes & self-heating packages. 	YES Always place on an up-turned plate on the turntable to prevent heat stress. Follow manufacturer's instructions. Be careful as these become very hot. Popcorn: Only use microwave popcorn within recommended packaging (follow popcorn manufacturer's instructions). Never use oil unless the manufacturer recommends and never cook for longer than instructed.
Metal cookware. 	NO
Aluminium foil and foil containers, made from "Microfoil®". 	YES Use small pieces of aluminium foil to shield food from overheating. Keep foil at least 2cm from the oven walls. Foil containers are not recommended unless specified by the manufacturer, e.g. MicroFoil®, follow instructions carefully.

Face & Hands: Always use oven gloves to remove food or cookware from the oven. Stand back when opening the oven door to allow heat or steam to disperse. When removing covers (such as cling-film), opening roasting bags or popcorn packaging, direct steam away from face and hands.

Check the temperature of food and drink and stir (before serving). Take special care when serving babies, children or the elderly. the contents of feeding bottles and baby food jars should be stirred or shaken and the temperature checked before consumption to avoid burns.

FOOD HANDLING & PREPARATION

Stir, turn & stand



For even cooking stir, turn or rearrange food during cooking. Where recommended, leave food to stand after cooking or defrosting.

Initial temperature



The initial temperature of food affects the amount of cooking time needed, for example, chilled food requires more cooking than food at room temperature. The temperature of the container is not a true indication of the temperature of the food or drink. Cut into foods with fillings, for example, jam doughnuts, to release heat or steam.

Piercing



Foods with a shell, skin or membrane must be pierced in several places before cooking or reheating as steam will build up and may cause food to explode, e.g. Potatoes, Fish, Chicken, Sausages.

NOTE: Eggs in their shells and whole hard / soft boiled eggs should not be heated in the microwave oven as they may explode, even after cooking has ended.

Arrangement



Place thickest parts of food on the outside of the dish, e.g. place the meaty ends of chicken drumsticks on the outside of the dish.

Covering



Fish, vegetables and certain other foods benefit from being covered during microwave cookery, follow recommendations where given and use vented microwave cling film or a suitable lid.

Size & shape



Food size and shape affect the amount of cooking time needed. When cooking more than one portion of the same food ensure they are of a similar size and shape.

Density & quantity



Food density and quantity affect the amount of cooking time needed, for example, potatoes require more cooking than peas; four potatoes will take longer to cook than two.

Composition & quality



Food high in fat or sugar (Christmas pudding, mince pies) requires less heating time and should be watched, over-heating can lead to fire. Use good quality ingredients for microwaving. Economical cuts of meat can be used for casseroles.

Hygiene



Food hygiene standards (storage, handling and preparation) apply to microwaving. Always store convenience foods as recommended by the food manufacturer and keep no longer than the "Use By" date.

ADVICE FOR DEFROSTING

Meat joints



Place on a plastic rack, turn over at least 4-5 times during defrosting, shield any warm areas with small, flat pieces of foil. After defrosting, wrap in foil and allow meat to stand for 45-60 minutes, until thoroughly defrosted.

Poultry

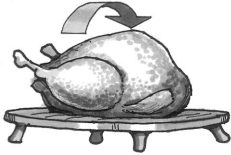

Place on a plastic rack, turn over at least 3-4 times during defrosting, shield any warm areas with small, pieces of foil. After defrosting, wrap in foil and allow poultry to stand for 45-60 minutes, until thoroughly defrosted.

NOTE: Do not defrost poultry with giblets.

Steak, Chops & Chicken Portions

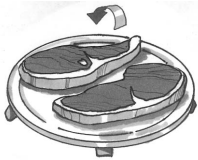

Place on a plastic rack, separate during defrosting and turn over at least 2-3 times. Shield if necessary.

Cubed & Minced Meat



Place in a bowl, remove defrosted parts and turn over at least 3-4 times during defrosting.

Whole fish & Fillets



Place in a flange dish, separate and turn over at least twice during defrosting. Shield if necessary.

Prepacked Frozen Foods



Remove packaging, including any foil and place in a suitable dish.

NOTES:

- To defrost food, use either 30% or 10% microwave power.
- Shield warm areas with small pieces of foil if necessary.
- It is important to turn food over, separate (where appropriate) and rearrange to ensure even defrosting.
- Standing time is necessary after defrosting to ensure thorough defrosting.

ADVICE FOR REHEATING

WARNINGS:

Oil & Fat: Never heat oil or fat for deep frying as this may lead to overheating and fire. Stand back when opening the oven door to allow heat or steam to disperse. When removing covers (such as cling-film), opening roasting bags or popcorn packaging, direct steam away from face and hands.

Never heat liquids in narrow-necked containers, as this could result in the contents erupting from the container and may cause burns.

- Remove food from foil or metal containers before reheating.
- Reheating times will be affected by the shape, depth, quantity and temperature of food together with the size, shape and material of the container.
- To avoid overheating and fire, special care must be taken when reheating foods with a high sugar or fat content, for example, mince pies, Christmas pudding.
- Canned potatoes should not be heated in the microwave oven, follow the manufacturers' instructions on the can.

Plated meals



Remove any poultry or meat portions, reheat these separately, see below. Place smaller items of food to the centre of the plate, larger and thicker foods to the edge. Cover with vented microwave cling film and reheat on 50%, stir/rearrange halfway through reheating. Ensure thoroughly reheated before serving.

Casseroles



Cover with vented microwave cling film or a suitable lid, reheat on 50%. Stir frequently to ensure even reheating.

Poultry portions

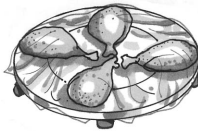

Place thickest parts of the portions on the outside of the dish, cover with microwave cling film and reheat on 70%. Turn over halfway through reheating.

NOTE: Ensure poultry is thoroughly reheated, before serving.

Sliced meat



Cover with vented microwave cling film and reheat on 50%. Rearrange at least once to ensure even reheating.

NOTE: Ensure meat is thoroughly reheated before serving.

Pies



Place pies on plate or in a flan dish. Reheat meat pies on 70% and fruit pies on 50%.

Vegetables

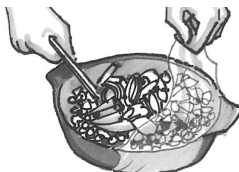

Cover with vented microwave cling film or suitable lid and reheat on 50%. Stir at least once during reheating.

D

EFROSTING CHART

MANUAL DEFROSTING

FOOD	DEFROSTING TIME	MICROWAVE POWER LEVEL	METHOD
Beef, Lamb & Pork Joints (uncooked)	18 mins /450g (1lb)	LOW (10%)	<ol style="list-style-type: none"> 1. Place on a large plate. 2. Turn over 4-5 times during defrosting. NOTE: If necessary, small pieces of aluminium foil can be used to shield small areas of meat which may become warm during defrosting. 3. After defrosting, wrap in foil and leave to stand for 30-60 minutes or until thoroughly defrosted.
Whole Poultry (uncooked)	11 mins /450g (1lb)	LOW (10%)	As above
Minced Beef (uncooked)	7-8 mins /450g (1lb)	MEDIUM LOW (30%)	<ol style="list-style-type: none"> 1. Place on a plate or in a flan dish. 2. Turn over 2-3 times during defrosting, removing defrosted mince each time. 3. After defrosting, cover any frozen mince remaining in aluminium foil for 15-20 minutes or until thoroughly defrosted.
Sausages (uncooked)	10-11 mins /450g (1lb)	LOW (10%)	<ol style="list-style-type: none"> 1. Place on a large plate, in a single layer if possible. 2. Turn over 2-3 times during defrosting and separate if necessary. 3. After defrosting, cover with aluminium foil and leave to stand for 15-20 minutes or until thoroughly defrosted.
Bacon (uncooked)	8-9 mins /450g (1lb)	LOW (10%)	<ol style="list-style-type: none"> 1. Place on a plate. 2. Separate and re-arrange twice during defrosting. 3. After defrosting, cover with aluminium foil and leave to stand for 5-10 minutes or until thoroughly defrosted.
Sausage Rolls Large (cooked)	3-4 mins for 8 rolls, 375g (13oz) Total weight	LOW (10%)	<ol style="list-style-type: none"> 1. Place on a large plate. 2. Turn over and re-arrange halfway through defrosting. 3. After defrosting, cover with foil and leave to stand for 10-15 minutes or until thoroughly cooked.
Quiche (cooked)	5-6 mins /450g (1lb)	LOW (10%)	<ol style="list-style-type: none"> 1. Place on a large plate. 2. After defrosting, cover with foil and leave to stand for 15-20 minutes or until thoroughly defrosted.
Meat Pie (cooked)	5-6 mins /450g (1lb)	LOW (10%)	As above.
Fruit Pie/ Crumble (cooked)	5-6 mins /450g (1lb)	LOW (10%)	As above.
Sponge Pudding (cooked)	4-5 mins /450g (1lb)	LOW (10%)	As above.

D

EFROSTING CHART

FOOD	DEFROSTING TIME	MICROWAVE POWER LEVEL	METHOD
Bread Sliced	6-7 mins /800g (1 ³ / ₄ lb) loaf	MEDIUM LOW (30%)	<ol style="list-style-type: none"> 1. Arrange slices on the turntable. 2. Turn over, separate and re-arrange twice during defrosting. Remove defrosted slices each time. 3. After defrosting, cover with foil for 5-10 minutes or until thoroughly defrosted.
Bread Buns	3-4 mins for 6 buns	LOW (10%)	<ol style="list-style-type: none"> 1. Place on turntable. 2. Turn over & re-arrange halfway through defrosting. 3. After defrosting, cover with foil and leave to stand for 5-10 minutes or until thoroughly defrosted.
Rice (cooked)	9 mins /450g (1lb)	MEDIUM LOW (30%)	<ol style="list-style-type: none"> 1. Place in a large bowl. 2. Break up and stir 2-3 times during defrosting. 3. After defrosting, cover bowl with foil and leave to stand for 10-15 minutes or until thoroughly defrosted.

NOTES:

- Prior to defrosting, food is frozen approx. -18°C.
- If it is necessary to shield small areas of food, use small pieces of foil.
- Only use food which is thoroughly defrosted, use a professional food thermometer to ensure acceptable temperatures have been achieved throughout.

C

OOKING CHART

FOOD	COOKING TIME	MICROWAVE POWERLEVEL	METHOD
Beef: Medium (Topside, Silverside) Chilled (5°C)	10-11 mins /450g (1lb)	MEDIUM HIGH (70%)	<ol style="list-style-type: none"> 1. Place fat side down in a flan dish. 2. Turn over halfway through cooking and remove juice. 3. After cooking, wrap in foil and leave to stand for 8 minutes before serving.
Lamb, medium (fillet, shoulder, leg) Chilled (5°C)	10-11 mins /450g (1lb)	MEDIUM HIGH (70%)	As above.
Pork (loin, leg) Chilled (5°C)	15-16 mins /450g (1lb)	MEDIUM HIGH (70%)	As above.
Poultry (whole) (max.3.5kg(8lb) Chilled (5°C)	7-8 mins /450g (1lb)	HIGH (100%)	<ol style="list-style-type: none"> 1. Place breast side down in a flan dish. 2. Turn over halfway through cooking and remove juice. 3. After cooking, wrap in foil and leave to stand for 10 minutes before serving.
Chicken/Duck Quarters Chilled (5°C)	7-8 mins /450g (1lb)	HIGH (100%)	<ol style="list-style-type: none"> 1. Place best side down in a single layer in a flan dish. 2. Turn over halfway through cooking, & remove juice. 3. After cooking, wrap in foil and leave to stand for 5 minutes before serving.
Minced Beef Chilled (5°C)	6-7 mins /450g (1lb)	MEDIUM HIGH (70%)	<ol style="list-style-type: none"> 1. Place in a large bowl. 2. Stir 2-3 times during cooking. 3. After cooking cover bowl with foil and leave to stand for 2-3 minutes before serving.
Bacon Chilled (5°C)	4 mins for 8 rashers	HIGH (100%)	<ol style="list-style-type: none"> 1. Place in a single layer on a large plate. 2. Turn over halfway through cooking. 3. Leave to stand for 1 minute before serving.
Burgers Chilled (5°C)	4 mins for 4 burgers	HIGH (100%)	As above
Sausages (thick) Chilled (5°C)	4 mins for 8 sausages	HIGH (100%)	As above
Sliced Gammon Chilled (5°C)	7 mins for 2 slices	HIGH (100%)	As above

C OOKING CHART

FOOD	COOKING TIME	MICROWAVE POWERLEVEL	METHOD
Fish Fillet/ Steaks Chilled (5°C)	6 mins /450g (1lb)	HIGH (100%)	<ol style="list-style-type: none"> 1. Place in a single layer in a large flan dish, cover with microwave cling film and pierce in 4-5 places. 2. Leave to stand for 2-3 minutes before serving.
Trout (whole) Chilled (5°C)	6-7 mins /450g (1lb)	HIGH (100%)	As above.
Rice/Pasta Room (20°C)	14-15 mins for 200g (70oz)	MEDIUM HIGH (70%)	<ol style="list-style-type: none"> 1. Place Rice/Pasta in a 2.5 litre casserole dish. 2. Add three times the volume of boiling water to quantity of rice. Do not cover. 3. Stir 3 times during cooking. 4. Stand for 2-3 minutes before rinsing in boiling water and serving.
Jacket Potatoes Room (20°C)	7 mins for 2 potatoes	HIGH (100%)	<ol style="list-style-type: none"> 1. Pierce each potato in several places. 2. Turn over halfway through cooking. 3. Stand for 3-4 minutes before serving.
Corn on the Cob Room 20°C Frozen -18°C	Fresh: 6 mins for 2 cobs Frozen: 9 mins for 2 cobs	HIGH (100%)	<ol style="list-style-type: none"> 1. Place in a dish, add 60ml (4tbsp) water. 2. Cover with microwave cling film pierce in 4-5 places. 3. Turn over halfway through cooking. 4. Stand for 1-2 minutes before serving.
Beans (green) Fresh: 20°C Frozen: -18°C	Fresh: 4 mins for 225g (8oz) Frozen: 4-5 mins for 225g (8oz)	HIGH (100%)	<ol style="list-style-type: none"> 1. Place in a dish, add 30ml (2tbsp) water. 2. Cover with microwave cling film and pierce in 4-5 places. 3. Stir halfway through cooking. 4. Stand for 1-2 minutes before serving.
Broccoli Fresh: 20°C Frozen: -18°C	Fresh: 4 mins for 225g (8oz) Frozen: 5 mins for 225g (8oz)	HIGH (100%)	As above
Carrots (sliced) Fresh: 20°C Frozen: -18°C	Fresh: 4-5 mins for 225g (8oz) Frozen: 5 mins for 225g (8oz)	HIGH (100%)	As above
Carrots (baby, whole) Fresh: 20°C Frozen: -18°C	Fresh: 4 mins for 225g (8oz) Frozen: 5 mins for 225g (8oz)	HIGH (100%)	As above
Cauliflower Fresh: 20°C Frozen: -18°C	Fresh: 4 mins for 225g (8oz) Frozen: 4-5 mins for 225g (8oz)	HIGH (100%)	As above

C OOKING CHART

FOOD	COOKING TIME	MICROWAVE POWERLEVEL	METHOD
Peas <i>Fresh: 20°C</i> <i>Frozen: -18°C</i>	Fresh: 3-4 mins for 225g (8oz) Frozen: 4-5 mins for 225g (8oz)	HIGH (100%)	<ol style="list-style-type: none"> 1. Place in a dish, add 30ml (2tbsp) water. 2. Cover with microwave cling film and pierce in 4-5 places. 3. Stir halfway through cooking. 4. Leave to stand for 1-2 minutes before serving.
New potatoes <i>Room 20°C</i>	7-8 mins for 450g (1lb)	HIGH (100%)	<ol style="list-style-type: none"> 1. Place in a large dish, add 60ml (4tbsp) water. 2. Cover dish with microwave cling film and pierce in 4-5 places. 3. Stir halfway through cooking. 4. Leave to stand for 1-2 minutes before serving.
Mushrooms (fresh) <i>Room 20°C</i>	3 mins for 225g (8oz)	HIGH (100%)	<ol style="list-style-type: none"> 1. Chop or leave whole as desired. 2. Place in dish, cover with microwave cling film and pierce in 4-5 places. 3. Stir halfway through cooking.
Tomatoes (fresh) <i>Room 20°C</i>	3 mins for 225g (8oz)	HIGH (100%)	<ol style="list-style-type: none"> 1. Slice or quarter as desired. NOTE: If you wish to leave whole, pierce in several places. 2. Place in a dish or on a plate, cover with microwave cling film and pierce in 4-5 places. 3. Leave to stand for 1-2 minutes before serving.
Scrambled Egg <i>Chilled 5°C</i>	4 mins	HIGH (100%)	<ol style="list-style-type: none"> 1. Place 6 eggs (size 3), 150ml (1/4 pint) milk, 15g (1/2oz) butter, salt and pepper in a bowl and beat thoroughly until smooth. 2. Beat 3 times during cooking until desirably set. 3. Leave to stand for 30 seconds before serving.

NOTES

- Only serve food which is thoroughly cooked, use a professional food thermometer to ensure acceptable temperatures have been reached throughout.
- Hygiene - see Food Handling & Preparation, Page 18
- When cooking joints of meat small pieces of aluminium foil can be used to shield small areas of meat if they start to overcook.
- During standing time food should be covered. If covered during cooking, leave covered. If cooked uncovered, cover with foil.

R

HEATING CHART

FOOD	TEMP	QUANTITY	METHOD	REHEATING TIME ON HIGH (100%)
BREAKFAST				
Porridge	Chilled	125g (5oz)	Place in a bowl, uncovered	1 min
Scrambled Egg	Chilled	125g (5oz)	Place on a plate, uncovered	50 sec
Scrambled Egg with bacon or sausage	Chilled	175g (6oz)	As above	1 min 30 sec
Bacon	Chilled	4 rashers	As above	40 sec
Sausages - thick	Chilled	4	As above	1 min
Smoked Haddock	Chilled	175g (6oz)	As above	1 min
Mushrooms	Chilled	100g (4oz)	Place in a bowl, uncovered	40 sec
Fresh Tomatoes	Chilled	100g (4oz)	As above	40 sec
HOT SANDWICHES				
Hamburger	Chilled	125g (5oz)	Place on a plate, uncovered	1 min
Cheeseburger	Chilled	175g (6oz)	As above	1 min
Hot Dog	Chilled	175g (6oz)	As above	1 min
Bacon	Chilled	175g (6oz)	As above	1 min
Sausage	Chilled	225g (8oz)	As above	1 min 30 sec
Beef	Chilled	175g (6oz)	As above	1 min
PREPARED DISHES				
Lasagne	Chilled	300g (11oz)	1. Place on a plate, cover with cling film 2. Stand covered for 2-3 minutes	3 min 30 sec
Chilli con Carne & Rice	Chilled	325g (12oz)	As above	3 min 30 sec
Curry & Rice	Chilled	300g (11oz)	As above	3 min 30 sec
Shepherds Pie	Chilled	300g (11oz)	As above	2 min 40 sec
Stew & Dumplings	Chilled	400g (14oz)	As above	3 min 30 sec

R

HEATING CHART

FOOD	TEMP	QUANTITY	METHOD	REHEATING TIME ON HIGH (100%)
PREPARED DISHES				
Bangers & Mash	Chilled	325g (12oz)	Place on a plate, cover with cling film	2 min 40 sec
Duck à l'orange	Chilled	540g (1lb 4oz)	As above	8 mins
Spaghetti Bolognese	Chilled	300g (11oz)	As above	2 min 40 sec
Chicken in a sauce	Chilled	300g (11oz)	As above	4 mins
Beef Stroganoff & Rice	Chilled	375g (13oz)	As above	4 mins
BBQ Ribs	Chilled	375g (13oz)	As above	3 min 20 sec
Rice/Pasta	Chilled	225g (8oz)	As above	1 min 50 sec
SAVOURY BREAD AND PASTRY				
Dinner Roll(s)	Chilled	1	Place on the turntable, uncovered	10 sec
		2	As above	15 sec
Croissant(s)	Chilled	1	As above	7 sec
		2	As above	10 sec
Garlic Bread	Chilled	250g (9oz)	As above	40 sec
Pizza Slice	Chilled	125g (5oz)	Place on a plate, uncovered	40 sec
	Frozen	100g (4oz)	As above	2 mins
Pizza - small	Chilled	75g (3oz)	As above	25 sec
	Frozen	100g (4oz)	As above	1 min 30 sec
Pizza - large	Chilled	400g (14oz)	As above	3 mins
	Frozen	400g (14oz)	As above	6 mins
Meat Pie - small	Chilled	125g (5oz)	1. Place on a plate, uncovered 2. Stand for 2-3 minutes	48 sec
Meat Pie - large	Chilled	450g (1lb)	1. Place on a plate, uncovered 2. Stand for 3-4 minutes	3 min 30 sec
Quiche - slice	Chilled	125g (5oz)	1. Place on a plate, uncovered 2. Stand for 2-3 minutes	50 sec
Quiche - whole	Chilled	540g (1lb 4oz)	1. Place on a plate, uncovered 2. Stand for 3-4 minutes	3 min 30 sec

R

HEATING CHART

FOOD	TEMP	QUANTITY	METHOD	REHEATING TIME ON HIGH (100%)
SAVOURY BREAD AND PASTRY				
Cornish Pastie(s) (175g)(6oz) each	Chilled	1	Place on a plate, uncovered	1 min
		2	As above	
Sausage Roll(s) 75g (3oz) each	Chilled	1	Place on a plate, uncovered	1 min 50 sec
		2	As above	
CANNED FOODS				
Baked Beans	Room	450g (1lb)	Place in a bowl, cover with cling film, stir halfway through cooking	3 mins
Sausage & Beans	Room	450g (1lb)	As above	3 min 25 sec
Soup - thick/thin	Room	425g (15oz)	As above	3 mins
Hot Dogs	Room	425g (15oz)	Place in a bowl, cover with cling film	3 mins
Peas	Room	550g (1lb 4oz)	Place in a bowl, cover with cling film, stir halfway through cooking	3 min 25 sec
Sweetcorn	Room	325g (12oz)	As above	3 mins
Potatoes	Room	540g (1lb 4oz)	As above	4 min 35 sec
Carrots - whole, sliced	Room	540g (1lb 4oz)	As above	4 mins
Tomatoes	Room	400g (14oz)	As above	3 min 25 sec
Asparagus	Room	350g (12oz)	As above	3 mins
Green Beans	Room	300g (11oz)	Place in a bowl, cover with cling film, stir halfway through cooking	3 min 25 sec
FRESH VEGETABLES				
Green Beans	Chilled	125g (5oz)	Place on a plate, uncovered	1 min
Broccoli	Chilled	125g (5oz)	Place on a plate, uncovered	1 min
Carrots - sliced	Chilled	125g (5oz)	Place on a plate, uncovered	1 min
Cauliflower	Chilled	125g (5oz)	Place on a plate, uncovered	1 min
Corn on the Cob	Chilled	200g (7oz)	Place on a plate, uncovered	1 min 50 sec
Peas	Chilled	100g (4oz)	Place on a plate, uncovered	1 min

R

REHEATING CHART

FOOD	TEMP	QUANTITY	METHOD	REHEATING TIME ON HIGH (100%)
FRESH VEGETABLES				
Jacket Potatoes	Chilled	250g (9oz)	Place on the turntable, uncovered	2 mins
New Potatoes	Chilled	225g (8oz)	Place on a plate, uncovered	2 mins
Brussels Sprouts	Chilled	225g (8oz)	Place on a plate, uncovered	1 min
MEAT PORTIONS				
Chicken Quarters	Chilled	1 (200g)(7oz)	Place on a plate, cover with cling film	2 mins
Lamb Chops	Chilled	3 (225g)(8oz)	Place on a plate, cover with cling film	1 min 30 sec
Pork Chop	Chilled	1 (125g)(5oz)	Place on a plate, cover with cling film	2 mins
Sliced Meat with Gravy	Chilled	1 (225g)(8oz)	Place on a plate, cover with cling film	3 mins
Gammon-sliced	Chilled	1(175g)(6oz)	Place on a plate, cover with cling film	1 min 30 sec
Trout & Salmon Steak	Chilled	1(200g)(7oz)	Place on a plate, cover with cling film	2 mins

R

REHEATING CHART

FOOD	TEMP	QUANTITY	METHOD	REHEATING TIME ON HIGH (100%)
SWEET PORTIONS				
Fruit Crumble	Chilled	175g (6oz)	Place in a bowl, uncovered	1 min
Fruit Crumble with custard	Chilled	275g (10oz)	Place in a bowl, uncovered	2 mins
Fruit Pie	Chilled	175g (6oz)	Place in a bowl, uncovered	1 min
Fruit Pie with Custard	Chilled	275g (10oz)	Place in a bowl, uncovered	1 min 30 sec
Sponge Pudding	Chilled	125g (5oz)	Place in a bowl, uncovered	40 sec
Sponge Pudding with Custard	Chilled	225g (8oz)	Place in a bowl, uncovered	1 min 30 sec
Suet Pudding	Chilled	175g (6oz)	Place in a bowl, uncovered	40 sec
Suet Pudding with Custard	Chilled	275g (10oz)	Place in a bowl, uncovered	1 min 30 sec
Chocolate Fudge Cake	Chilled	125g (5oz)	Place on a plate, uncovered	40 sec

NOTES

- Only serve food which is thoroughly reheated, use a professional food thermometer to ensure acceptable temperatures have been reached throughout.
- Temperatures referred to in this chart are: *Room*, approx. 20°C, *Chilled*, approx. 5°C, and *Frozen*, approx. -18°C
- Hygiene - see Food Handling & Preparation, Page 18
- During standing time (where recommended) food should be covered. If covered during reheating, leave covered. If reheated uncovered, cover with foil.

C

LEANING & MAINTENANCE

WARNING

- Do not allow grease or dirt to build up on the door seals and adjacent parts as this may prevent the door from closing correctly and may cause a leakage of microwaves. To clean use a mild detergent solution on a soft damp cloth.
- Keep the ceramic floor clean at all times. If you leave grease or fat in the cavity, it may overheat, smoke or even catch fire when next using the oven.
- Never use spray cleaners, oven keys or abrasive scourers as these damage the surface of the oven.
- Do not remove the ceramic floor from the oven.
- Do not operate the oven without the air ventilation cover.
- Do not use commercial oven cleaners, abrasive or harsh cleaners or scouring pads on any part of your microwave oven.
- Do not sprinkle water onto the oven directly. It may cause electric shock, leakage of electricity or damage of the oven.
- Failure to maintain the oven in a clean condition could lead to deterioration of the surface that could adversely affect the life of the appliance and possibly result in a hazardous situation.

OVEN INTERIOR

Clean the microwave oven cavity, at the end of each day with a damp soft cloth. For heavier soil, use mild soap applied with a soft damp cloth wipe clean ensuring all mild soap is removed. Make sure that mild soap or water does not penetrate through the small vents in the walls which may cause damage to the oven. Take care not to let soapy water drip through the small holes in the oven

walls. Excess water spillage through these holes will cause damage to the oven interior. It is important that the door seals and sealing surfaces are kept clean at all times, wipe regularly with a damp cloth. The ceramic floor should be kept clean at all times. Minor spills may be wiped with a damp cloth.

OUTER CABINET

Wipe the outside cabinet with a mild detergent solution on a soft cloth. The control panel must be wiped clean whilst the door is open, therefore inactivating the oven.

AIR INTAKE FILTER

Keep the air intake filter clean. Clean the air intake filter once every two weeks.

Wash the air intake filter in mild soapy water, rinse and dry with a soft cloth.

You can remove the air intake filter easily using a coin (less than 2mm thick.)

Do not operate the oven without the air intake filter in place.

Removal:

1. Remove one special screw (A) as shown in Fig.1.
2. Remove the upper holder from the air intake filter.
3. Remove the air intake filter from the lower holder.

Reinstall:

1. Insert the air intake filter into the slot of the lower holder.
2. Place the upper holder on the air intake filter.
3. Secure the upper holder and air intake filter to the oven with one special screw (A) as shown in Fig. 1.

Fig. 1

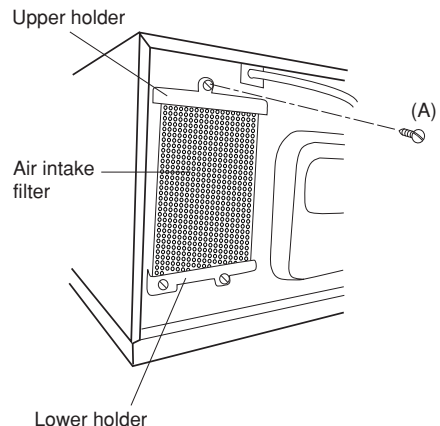

TROUBLESHOOTING

If you think the oven is not working properly there are some simple checks which you can carry out yourself before you call for an engineer. This will help prevent unnecessary service calls if the fault is something simple.

Simply answer "YES" or "NO" to the following questions:

1 Does the oven lamp come on when you open the door? **YES/NO**

Put half a cup of water on the ceramic floor in the oven and close the door. Cook for 1 minute at 100%.

2 Does the oven lamp come on? **YES/NO**

3 Does the fan motor work? (Check by placing your hand above the air vent openings) **YES/NO**

4 After 1 minute does the "Beep" signal sound? **YES/NO**

5 And did the heating indicator "ON" go out? **YES/NO**

6 Is the water in the cup hot? **YES/NO**

If you answer "NO" to any question first check that the oven is plugged in properly and the fuse has not blown, if there is no fault with either, check against the troubleshooting chart below.

WARNINGS:

• Never adjust, repair or modify the oven yourself, or allow anyone other than a Service Technician, appointed by SHARP to carry out the service.

- The door seal stops microwave leakage during oven operation, but does not form an airtight seal. It is normal to see drops of water, light or feel warm air around the oven door. Food with a high moisture content will release steam and cause condensation inside the door which may drip from the oven.
- Repairs & Modifications: Do not attempt to operate the oven if it is not working properly.
- Outer Cabinet & Lamp Access: Never remove the outer cabinet. This would be very dangerous due to high voltage parts inside which must never be touched, as this could be fatal. Your oven is not fitted with a lamp access cover. If the lamp fails do not attempt to replace the lamp yourself, please contact your supplier.

PROBLEM	POSSIBLE CAUSE
Draught circulates around the door.	When oven is working, air circulates within the cavity. The door does not form an airtight seal so air may escape from the door.
Condensation forms in the oven, and may drip from the door.	The oven cavity will normally be colder than the food being cooked, and so steam produced when cooking will condense on the colder surface. The amount of steam produced depends on the water content of the food being cooked. Some foods, such as potatoes have a high moisture content. Condensation trapped in the door glass should clear after a few hours.
Flashing or arcing from within the cavity when cooking.	Arcing will occur when a metallic object comes into close proximity to the oven cavity during cooking. This may possibly roughen the surface of the cavity, but would not otherwise damage the oven.
Arcing potatoes.	Ensure all "eyes" are removed and place in a heat resistant flan dish or similar.
After setting the time, the oven does not start.	Check the door is closed properly.
Oven cooks too slowly.	Ensure correct power level has been selected.
Oven makes a noise.	The microwave energy pulses ON/OFF during cooking/defrosting.
Outer cabinet is hot.	The cabinet may become warm to the touch - keep children away

T

O REPLACE THE MAINS PLUG

The wires in the mains cable are colour coded as shown opposite:

green and yellow stripes = **EARTH**
blue = **NEUTRAL**
brown = **LIVE**

As the colours of the cores in the mains lead of your oven may not correspond with the coloured marking identifying the terminals in your plug, connect the wires as shown: Make sure the terminal screws are tight and the cable is held securely by the cable grip where it enters the plug. Like most appliances in your home, your oven must be connected to a single phase 230-240 Volt, 50Hz alternating current supply.

If you do not make the proper electrical connections you might damage the oven or injure yourself. Neither SHARP nor the supplier will be liable if this happens.

- The green and yellow wire to the plug terminal marked E or \equiv or coloured green or coloured green and yellow.
- The blue wire to the plug terminal marked N or coloured black or coloured blue.
- The brown wire to the plug terminal marked L or coloured red or coloured brown.

WARNING:

**THIS APPLIANCE MUST BE EARTHED.
IF YOU HAVE ANY DOUBTS ABOUT YOUR
ELECTRICAL SUPPLY ASK A QUALIFIED
ELECTRICIAN.**

C

ALLING FOR SERVICE

- If you are unable to resolve a problem using the checks covered on the last few pages, do not attempt to service this microwave oven yourself.
- Contact the dealer or supplier from whom the oven was purchased in order to obtain service.
01296 663400 (office hours)
- For general information & assistance with oven queries, please contact our help desk:
Telephone: 01296 663400 (office hours)
e-mail: customerservice@rhhall.com

SPECIFICATIONS:

AC Line voltage	Single phase 230-240V, 50Hz
AC Power required	1.55kW
Output power	1000W (IEC 60705)
Microwave frequency	2450MHz *(Group 2 / Class B)
Sound level	less than 70dB (A)
Outside dimensions	520(W) x 309(H) x 406(D) mm
Cavity dimensions	351(W) x 211(H) x 372(D) mm
Oven capacity	1.0 cu.ft (28 litres)
Cooking uniformity	Rotary antenna system
Weight	Approx. 18kg

* This Product fulfils the requirement of the European standard EN55011. In conformity with this standard, this product is classified as group 2 class B equipment. Group 2 means that the equipment intentionally generates radio-frequency energy in the form of electromagnetic radiation for heating treatment of food. Class B equipment means that the equipment suitable to be used in domestic establishments.

(This product is designed for commercial application only and as such it falls outside the scope of Regulation (EC) 1275/2008 implementing EU Directive 2005/32/EC on eco-design requirements for standby and off mode electric power consumption. Sharp do not recommend the product for domestic application and will not accept any liability for such use.)

- As part of a policy of continuous improvement, we reserve the right to alter design and specification without notice.

NOTE: External Equipotential Earthing Terminal

Equipment has secondary earthing terminal. Terminal provides external earthing connection used in addition to earthing prong on plug. Located on outside of oven back, terminal is marked with symbol shown on the right side.





Information on the Disposal of this Equipment

IF YOU WISH TO DISPOSE OF THIS EQUIPMENT, DO NOT USE THE ORDINARY WASTE BIN, AND DO NOT PUT THEM INTO A FIREPLACE!

Used electrical and electronic equipment should always be collected and treated SEPARATELY in accordance with local law.

Separate collection promotes an environment-friendly treatment, recycling of materials, and minimizing final disposal of waste. IMPROPER DISPOSAL can be harmful to human health and the environment due to certain substances! Take USED EQUIPMENT to a local, usually municipal, collection facility, where available.

If in doubt about disposal, contact your local authorities or dealer and ask for the correct method of disposal.

ONLY FOR USERS IN THE EUROPEAN UNION, AND SOME OTHER COUNTRIES; FOR INSTANCE NORWAY AND SWITZERLAND: Your participation in separate collection is requested by law.

The symbol shown above appears on electrical and electronic equipment (or the packaging) to remind the users of this.

Users from PRIVATE HOUSEHOLDS are requested to use existing return facilities for used equipment. Return is free of charge.

If the equipment has been used for BUSINESS PURPOSES, please contact your SHARP dealer who will inform you about take-back. You might be charged for the costs arising from take-back. Small equipment (and small quantities) might be taken back by your local collection facility. For Spain: Please contact the established collection system or your local authority for take-back of your used products.

Manufacturer:

SHARP Corporation

1 Takumi-cho, Sakai-ku, Sakai-shi, Osaka 590-8522, Japan

Authorised Representative:

SHARP Electronics Europe Ltd.

4 Furzeground Way, Stockley Park, Uxbridge, Middlesex, UB11 1EZ, UK

SHARP Electronics GmbH

Nagelsweg 33-35, 20097 Hamburg, Germany



TINSEB417WRRZ-K11