



KS-76S50BNP-EU

Cooking

EN User Manual





SHARP

Be Original.

Thank you for choosing this product.

This User Manual contains important safety information and instructions on the operation and maintenance of your appliance.

Please take the time to read this User Manual before using your appliance and keep this book for future reference.

Icon	Type	Meaning
	WARNING	Serious injury or death risk
	RISK OF ELECTRIC SHOCK	Dangerous voltage risk
	FIRE	Warning; Risk of fire / flammable materials
	CAUTION	Injury or property damage risk
	IMPORTANT / NOTE	Operating the system correctly

CONTENTS

1.SAFETY INSTRUCTIONS.....	4
1.1 General Safety Warnings	4
1.2 Installation Warnings	6
1.3 During Use	7
1.4 During Cleaning and Maintenance	8
2.INSTALLATION AND PREPARATION FOR USE.....	9
2.1 Instructions for the Installer	9
2.2 Installation of the Oven.....	9
2.3 Electrical Connection and Safety.....	10
3.PRODUCT FEATURES	12
4.USE OF PRODUCT	13
4.1 Oven Controls.....	13
4.2 Cooking Table	14
4.3 Use of the Smart LCD Control Unit	14
4.4 Accessories	25
5.CLEANING AND MAINTENANCE.....	28
5.1 Cleaning	28
5.2 Maintenance.....	30
6.TROUBLESHOOTING&TRANSPORT	31
6.1 Troubleshooting.....	31
6.2 Transport	31
7.TECHNICAL SPECIFICATIONS.....	32
7.1 Energy Fiche	32



1. SAFETY INSTRUCTIONS



- Carefully read all instructions before using your appliance and keep them in a convenient place for reference when necessary.
- This manual has been prepared for more than one model therefore your appliance may not have some of the features described within. For this reason, it is important to pay particular attention to any figures whilst reading the operating manual.

1.1 GENERAL SAFETY WARNINGS

- This appliance can be used by children aged from 8 years and above and by persons with reduced physical, sensory or mental capabilities or lack of experience and knowledge if they have been given supervision or instruction concerning use of the appliance in a safe way and understand the hazards involved. Children should not play with the appliance. Cleaning and user maintenance should not be made by children without supervision.

 **WARNING:** The appliance and its accessible parts become hot during use. Care should be taken to avoid touching heating elements. Keep children less than 8 years of age away unless they are continually supervised.

  **WARNING:** Danger of fire: Do not store items on the cooking surfaces.

  **WARNING:** If the surface is cracked, switch off the appliance to avoid the possibility of electric shock.

- Do not operate the appliance with an external timer or separate remote-control system.
- During use the appliance will get hot. Care should be taken to avoid touching heating elements inside

the oven.

- Handles may get hot after a short period during use.
- Do not use harsh abrasive cleaners or scourers to clean the oven door glass and other surface. They can scratch the surfaces which may result in shattering of the door glass or damage to surfaces.
- Do not use steam cleaners for cleaning the appliance.

 **WARNING:** To avoid the possibility of electric shock, make sure that the appliance is switched off before replacing the lamp.

 **CAUTION:** Accessible parts may be hot when cooking or grilling. Keep young children away from the appliance when it is in use.

- Your appliance is produced in accordance with all applicable local and international standards and regulations.
- Maintenance and repair work should only be carried out by authorised service technicians. Installation and repair work that is carried out by unauthorised technicians may be dangerous. Do not alter or modify the specifications of the appliance in any way. Inappropriate hob guards can cause accidents.
- Before connecting your appliance, make sure that the local distribution conditions (nature of the gas and gas pressure or electricity voltage and frequency) and the specifications of the appliance are compatible. The specifications for this appliance are stated on the label.

 **CAUTION:** This appliance is designed only for cooking food and is intended for indoor domestic household use only. It should not be used for any other purpose or in any other application, such as for non-domestic use, in a commercial environment or for

heating a room.



- Do not use the oven door handles to lift or move the appliance.
- All possible measures have been taken to ensure your safety. Since the glass may break, care should be taken while cleaning to avoid scratching. Avoid hitting or knocking the glass with accessories.
- Make sure that the supply cord is not trapped or damaged during installation. If the supply cord is damaged, it must be replaced by the manufacturer, its service agent or similarly qualified persons in order to prevent a hazard.
- Do not let children climb on the oven door or sit on it while it is open.
- Please keep children and animals away from this appliance.

1.2 INSTALLATION WARNINGS

- Do not operate the appliance before it is fully installed.
- The appliance must be installed by an authorised technician. The manufacturer is not responsible for any damage that might be caused by defective placement and installation by unauthorised people.
- When the appliance is unpacked, make sure that it has not been damaged during transportation. In case of any defect do not use the appliance and contact a qualified service agent immediately. The materials used for packaging (nylon, staplers, Styrofoam, etc.) may be harmful to children and they should be collected and removed immediately.
- Protect your appliance from the atmosphere. Do not expose it to effects such as sun, rain, snow, dust or excessive humidity.

- Any materials (i.e. cabinets) around the appliance must be able to withstand a minimum temperature of 100°C.
- The appliance must not be installed behind a decorative door, in order to avoid overheating.

1.3 DURING USE

- When you first use your oven you may notice a slight smell. This is perfectly normal and is caused by the insulation materials on the heater elements. We suggest that, before using your oven for the first time, you leave it empty and set it at maximum temperature for 45 minutes. Make sure that the environment in which the product is installed is well ventilated.
 - Take care when opening the oven door during or after cooking. The hot steam from the oven may cause burns.
 - Do not put flammable or combustible materials in or near the appliance when it is operating.
 - Always use oven gloves to remove and replace food in the oven.
 - Under no circumstances should the oven be lined with aluminium foil as overheating may occur.
 - Do not place dishes or baking trays directly onto the base of the oven whilst cooking. The base becomes very hot and damage may be caused to the product.
-   Do not leave the oven unattended while cooking with solid or liquid oils. They may catch fire under extreme heating conditions. Never pour water on to flames that are caused by oil, instead switch the oven off and cover the pan with its lid or a fire blanket.
- If the product will not be used for a long period of time, turn the main control switch off.

- Make sure the appliance control knobs are always in the “0” (stop) position when it is not in use.
- The trays incline when pulled out. Take care not to spill or drop hot food while removing it from the ovens.
- Do not place anything on the oven door when it is open. This could unbalance the oven or damage the door.
- Do not hang towels, dishcloths or clothes from the appliance or its handles.

1.4 DURING CLEANING AND MAINTENANCE

- Make sure that your appliance is turned off at the mains before carrying out any cleaning or maintenance operations.
- Do not remove the control knobs to clean the control panel.
- To maintain the efficiency and safety of your appliance, we recommend you always use original spare parts and to call our authorised service agents in case of need.

CE Declaration of conformity

 We declare that our products meet the applicable European Directives, Decisions and Regulations and the requirements listed in the standards referenced.

This appliance has been designed to be used only for home cooking. Any other use (such as heating a room) is improper and dangerous.

 The operating instructions apply to several models. You may notice differences between these instructions and your model.

2. INSTALLATION AND PREPARATION FOR USE

! WARNING : This appliance must be installed by an authorised service person or qualified technician, according to the instructions in this guide and in compliance with the current local regulations.

- Incorrect installation may cause harm and damage, for which the manufacturer accepts no responsibility and the warranty will not be valid.
- Prior to installation, ensure that the local distribution conditions (electricity voltage and frequency) and the adjustments of the appliance are compatible. The adjustment conditions for this appliance are stated on the label.
- The laws, ordinances, directives and standards in force in the country of use are to be followed (safety regulations, proper recycling in accordance with the regulations, etc.).

2.1 INSTRUCTIONS FOR THE INSTALLER

General instructions

- After removing the packaging material from the appliance and its accessories, ensure that the appliance is not damaged. If you suspect any damage,

do not use it and contact an authorised service person or qualified technician immediately.

- Make sure that there are no flammable or combustible materials in the close vicinity, such as curtains, oil, cloth etc. which may catch fire.
- The worktop and furniture surrounding the appliance must be made of materials resistant to temperatures above 100°C.
- The appliance should not be installed directly above a dishwasher, fridge, freezer, washing machine or clothes dryer.

2.2 INSTALLATION OF THE OVEN

The appliances are supplied with installation kits and can be installed in a worktop with the appropriate dimensions. The dimensions for hob and oven installation are given below.

A (mm)	557	min./max. F (mm)	560/580
B (mm)	550	min. G (mm)	555
C (mm)	595	min. H/I (mm)	600/590
D (mm)	575	min. J/K (mm)	5/10
E (mm)	574		

Installation under a worktop

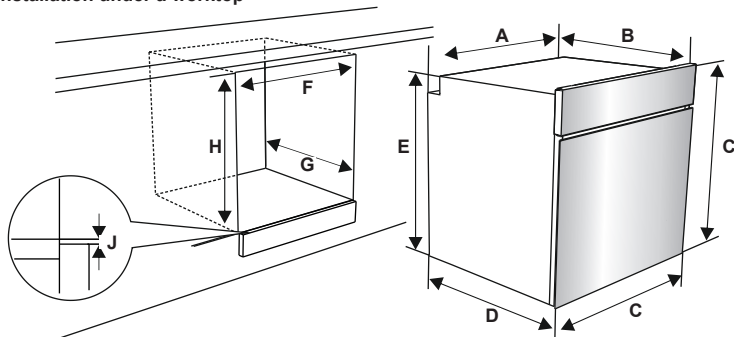

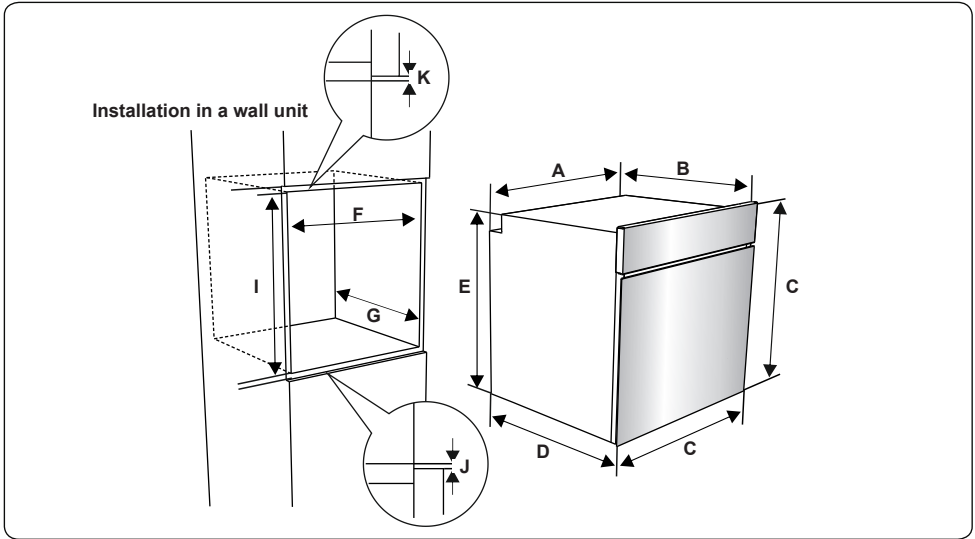

After making the electrical connections, insert the oven into the cabinet by pushing it forward. Open the oven door and insert 2 screws in the holes located on the oven frame. While the product frame touches the wooden surface of the cabinet, tighten the screws.

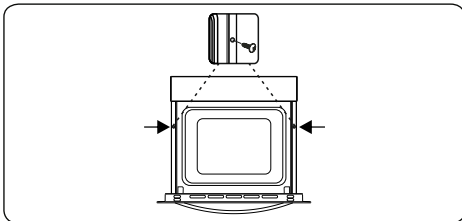

2.3 ELECTRICAL CONNECTION AND SAFETY

WARNING: The electrical connection of this appliance should be carried out by an authorised service person or qualified electrician, according to the instructions in this guide and in compliance with the current local regulations.

WARNING: THE APPLIANCE MUST BE EARTHED.

- Before connecting the appliance to the power supply, the voltage rating of the appliance (stamped on the appliance identification plate) must be checked for correspondence to the available mains supply voltage, and the mains electric wiring should be capable of handling the

appliance's power rating (also indicated on the identification plate).

- During installation, please ensure that isolated cables are used. An incorrect connection could damage your appliance. If the mains cable is damaged and needs to be replaced this should be done by a qualified personnel.
- Do not use adaptors, multiple sockets and/or extension leads.
- The supply cord should be kept away from hot parts of the appliance and must not be bent or compressed. Otherwise the cord may be damaged, causing a short circuit.
- If the appliance is not connected to the mains with a plug, a all-pole disconnector (with at least 3 mm contact spacing) must be used in order to meet the safety regulations.
- The appliance is designed for a power supply of 220-240V ~ and 380-415V 3N~. If your supply is different, contact the authorised service person or a qualified electrician.
- The power cable (H05VV-F) must be long enough to be connected to the appliance, even if the appliance stands on the front of its cabinet.
- Ensure all connections are adequately tightened.

- Fix the supply cable in the cable clamp and then close the cover.
- The terminal box connection is placed on the terminal box.

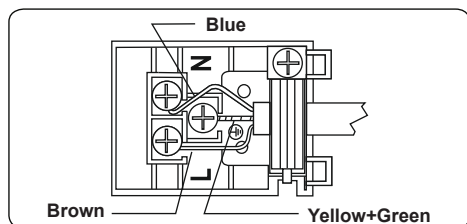

3. PRODUCT FEATURES

 **Important:** Specifications for the product vary and the appearance of your appliance may differ from that shown in the figures below.

List of Components

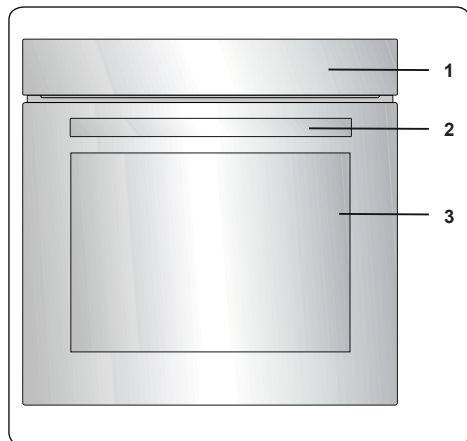

1. Control Panel
2. Oven Door Handle
3. Oven Door

Control Panel

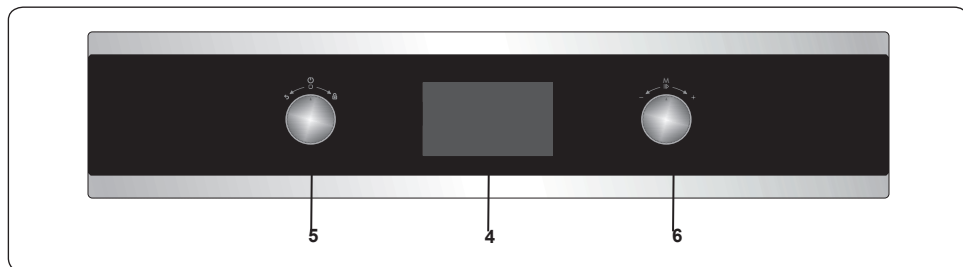

4. Timer
5. Oven Function Control Knob
6. Oven Thermostat Knob

4. USE OF PRODUCT

4.1 OVEN CONTROLS

Left knob

- Long push: Switch on / off
- Short push: Pause cooking
- Turn right: Key lock
- Turn left: Undo / Go to previous menu

Right knob

- Push: Select / Start cooking
- Turn right: Menu navigation / Increase temperature
- Turn left: Menu navigation / Decrease temperature

Oven Functions

* The functions of your oven may be different due to the model of your product.

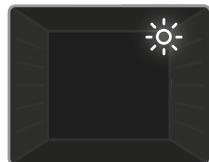

Oven Lamp: Only the oven light will switch on. It will remain on for the duration of the cooking function.



Defrost Function: The oven's warning lights will switch on and the fan will start to operate. To use the defrost function, place your frozen food in the oven on a shelf in the third slot from the bottom. It is recommended that you place an oven tray under the defrosting food, to catch the water accumulated due to melting ice. This function will not cook or bake your food, it will only help to defrost it.

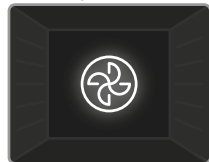

Turbo Function: The oven's thermostat and warning lights will switch on, and the ring heating element and fan will start operating. The turbo function evenly disperses the heat in the oven so all food on all racks will cook evenly. It is recommended that you preheat the oven for about 10 minutes.

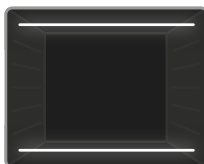

Static Cooking Function: The oven's thermostat and warning lights will switch on, and the lower and upper heating elements will start operating. The static cooking function emits heat, ensuring even cooking of food. This is ideal for making pastries, cakes, baked pasta, lasagne and pizza. Preheating the oven for 10 minutes is recommended and it is best to use only one shelf at a time in this function.



Fan Function: The oven's thermostat and warning lights will switch on, and the upper and lower heating elements and fan will start operating. This function is good for baking pastry. Cooking is carried out by the lower and upper heating elements within the oven and by the fan, which provides air circulation, giving a slightly grilled effect to the food. It is recommended that you preheat the oven for about 10 minutes.

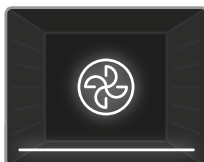

Pizza Function: The oven's thermostat and warning lights will switch on, and the ring, lower heating elements and fan will start operating. This function is ideal for baking food, such as pizza, evenly in a short time. While the fan evenly disperses the heat of the oven, the lower heating element ensures baking of the food.

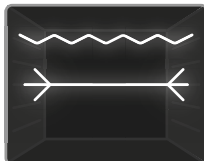

Grilling and Roasting Chicken Function: The oven's thermostat and warning lights will switch on, and the grill heating element and turnspit will start operating. This function is used for grilling and toasting food, as well as for roasting chicken using the roasting skewer. For grilling, use the upper shelves of the oven. Lightly brush the wire grid with oil to stop foods sticking and place food in the centre of the grid. Always place a tray beneath the food to catch any drips of oil or fat. When roasting chicken, please refer to the accessories section. We recommend

preheating the oven for about 10 minutes when using this function.

Warning: When grilling, the oven door must be closed and the oven temperature should be adjusted to 190°C.

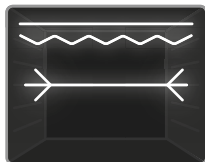

Faster Grilling and Roasting Chicken Function:

The oven's thermostat and warning lights will switch on, and the grill, upper heating elements and turnspit will start operating. This

function is used for faster grilling and for grilling foods with a larger surface area, such as meat. It is also suitable for roasting chicken with the roasting skewer. For grilling, use the upper shelves of the oven. Lightly brush the wire grid with oil to stop foods sticking and place food in the centre of the grid. Always place a tray beneath the food to catch any drips of oil or fat. When roasting chicken, please see the accessories section. We recommend preheating the oven for about 10 minutes when using this function.

Warning: When grilling, the oven door must be closed and the oven temperature should be adjusted to 190°C.



Double Grill - Fan and Roasting Chicken Function:

The oven's thermostat and warning lights will illuminate, and the grill, upper heating

elements, fan and turnspit will start operating. This function is used for fast grilling of thick food, for cooking food with a large surface area and for roasting chicken with the roasting skewer. Both the upper elements of the grill will be energised along with the fan to ensure even cooking. For grilling, use the upper shelves of the oven. Lightly brush the wire grid with oil to stop food from sticking and place food in the centre of the grid. Always put a tray underneath the food to catch any drips of oil or fat. When roasting chicken, please see the accessories section. We recommend that you preheat the oven for about 10 minutes.

Warning: When grilling, the oven door must be closed and the oven temperature should be adjusted to 190°C.



Vap Clean Function: Set the oven function and thermostat to the Vap Clean function symbol. Pour 200-250ml of water (about 1 cup) into the small tray on the oven base. Vap Clean runs for approximately 20 minutes and will prepare your oven so that it can be easily cleaned.

4.2 COOKING TABLE

Function	Dishes			
Static	Puff Pastry	2-3-4	170-190	35-45
	Cake	2-3-4	170-190	30-40
	Cookie	2-3-4	170-190	30-40
	Stew	2	175-200	40-50
	Chicken	2-3-4	200	45-60
Fan	Puff Pastry	1 - 2	170-190	25-35
	Cake	2-3-4	150-170	25-35
	Cookie	2-3-4	150-170	25-35
	Stew	2	175-200	40-50
	Chicken	2-3-4	200	45-60
Turbo	Puff Pastry	2-3-4	170-190	35-45
	Cake	2-3-4	150-170	30-40
	Cookie	2-3-4	150-170	25-35
	Stew	2	175-200	40-50
Grilling	Grilled meatballs	5	200	10-15
	Chicken	*	190	50-60
	Chop	4-5	200	15-25
	Beefsteak	4-5	200	15-25

*If available cook with roast chicken skewer.

4.3 USE OF THE SMART LCD CONTROL UNIT

Ready Cook is designed to help home users to implement professional cooking recipes easily using the built-in auto cooking functions.

The Ready Cook menus, such as Manual Cooking, Auto Cooking, Favourites, Cleaning, and Settings, are described below.

Manual cooking

You can adjust every cooking setting in Manual Cooking mode, including the 7 different cooking functions, the temperature, the boost function, the cooking duration, and the cooking end time. Follow the steps listed below to navigate the Manual Cooking menu.

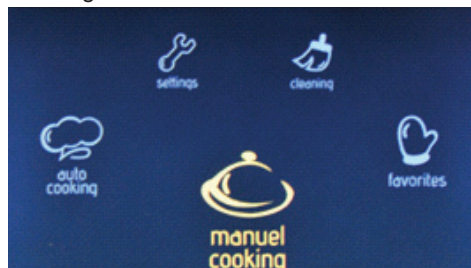

The main menu

- Rotate the right knob in either direction until **“Manual Cooking”** is highlighted.
- Press the right knob to select the highlighted option.

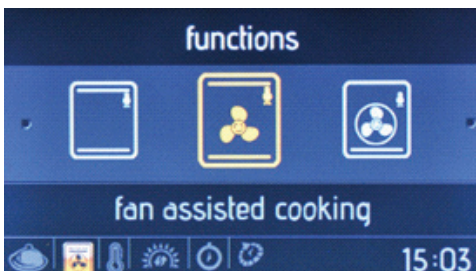

Oven function

- Rotate the right knob in either direction to navigate between the available oven functions.
- Press the right knob to select the highlighted option.



Temperature

- Rotate the right knob in either direction to navigate between the available temperature settings.
- Press the right knob to select the highlighted option.

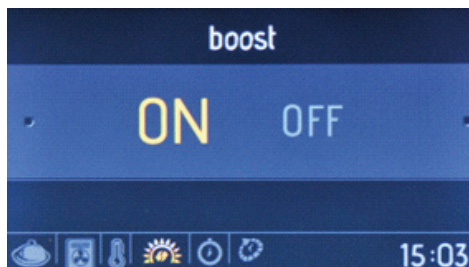

Boost

- Rotate the right knob in either direction to highlight Boost **“ON”** or **“OFF”**.
- Press the right knob to select the highlighted option.
- Use this function to heat the oven the desired temperature as quickly as possible. This mode is not appropriate for cooking.



Cooking duration

- Rotate the right knob in either direction to change the cooking duration.
- Press the right knob to set the cooking duration.
- **NOTE:** If the cooking duration is set to **00:00**, cooking will continue until you manually stop it.

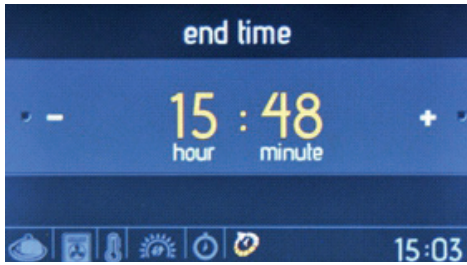

Cooking end time

- Rotate the right knob in either direction to change the cooking end time.
- Press the right knob to set the cooking end time.



The information screen

- Cooking will begin within 10 seconds of the last action, or when the right knob is pressed.
- Rotate the left knob anti-clockwise to go back to the previous setting.



The animation screen displays:

- Cooking time
- Temperature
- Cooking start and end time
- Cooking function information.



The animation screen

- Press the left knob to stop cooking.
- Press the right knob to start / continue cooking.
- Rotate the right knob in either direction to change the temperature.
- Rotate the left knob anti-clockwise, while any cooking function is active, to display the oven function, temperature, and cooking time setting screen.
- To stop cooking and return to the main menu, press the left knob then rotate it anti-clockwise.

Auto Cooking

Ready Cook has built-in, previously determined, recipe functions that can be selected in the Auto Cooking menu. You will only be able to select the name of the desired meal. It will not be possible to alter any of the recipe settings, including cooking duration and temperature, as these are automatically set by Ready Cook.

Follow the steps below to perform auto cooking.

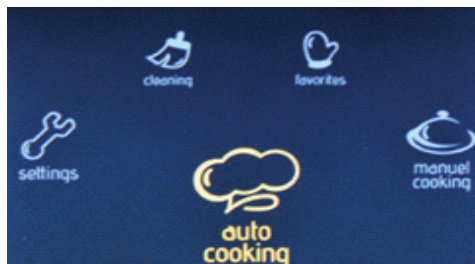

The main menu

- Rotate the right knob in either direction until **“Auto Cooking”** is highlighted.
- Press the right knob to select the highlighted option.

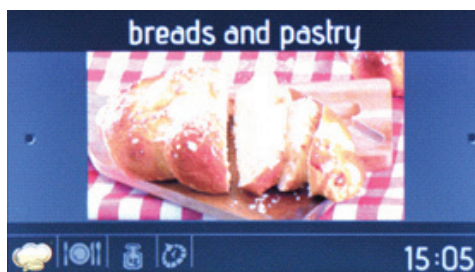

Food categories

- Rotate the right knob in either direction to navigate between the available recipes.
- Press the right knob to select the highlighted option.



Recipe selection

- Rotate the right knob in either direction to navigate between the available recipes.
- Press the right knob to select the highlighted option.



Food weight

- Rotate the right knob in either direction to change the weight value.
- Press the right knob to set the weight.

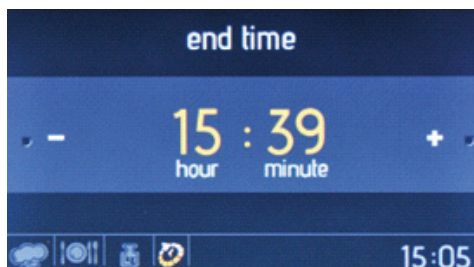

Cooking end time

- Rotate the right knob in either direction to change the cooking end time.
- Press the right knob to set the cooking end time.

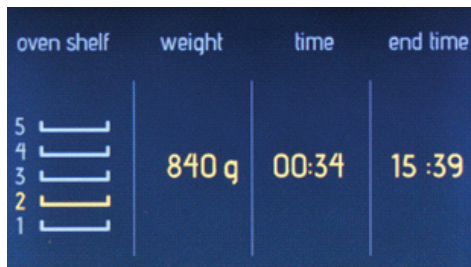

The information screen

- Cooking will start within 10 seconds of no activity, or when the right knob is pressed.
- Rotate the left knob anti-clockwise to go back through the previous setting screens.
- Place food on the middle shelf to achieve the best cooking results.

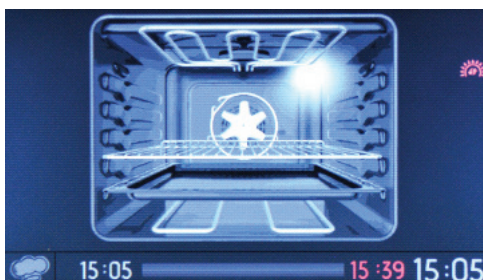

The animation screen

- Press the left knob to stop cooking.
- Press the right knob to start and continue cooking.
- To stop cooking and return to the main menu, press the left knob and rotate it anti-clockwise.

Favourites

It is possible to save your manual cooking settings, allowing you to quickly select the same cooking settings at any time. At the end of the Manual Cooking menu, after the cooking duration setting, you will be asked whether you want to save the settings to your favourites.

To create a favourite cooking setting, use the edit function in the Favourites menu.

To select and begin a favourite function, follow the steps below.

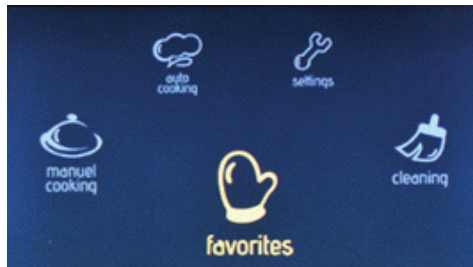

On the main menu

- Rotate the right knob in either direction until 'Favourites' is highlighted.
- Press the right knob to select the highlighted option.

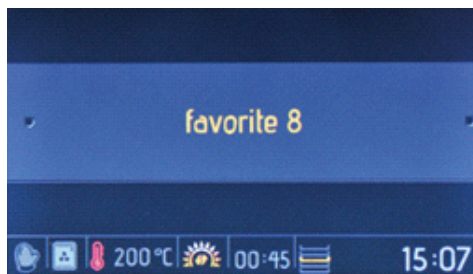

Favourites

- Rotate the right knob in either direction to navigate between the available options.
- Press the right knob to select the highlighted option.
- The settings stored in the favourite will be displayed at the bottom of the screen.

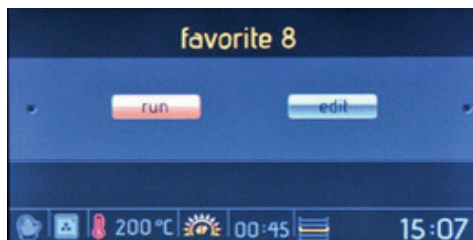

The run/edit screen

- Rotate the right knob to highlight "Run".
- Press the right knob to select "Run".

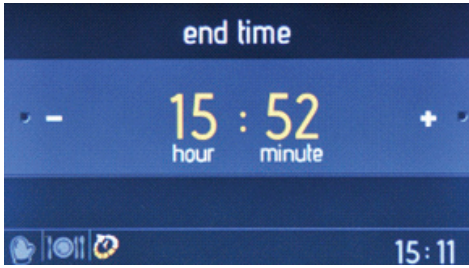

Cooking end time

- Rotate the right knob in either direction to change the cooking end time.
- Press the right knob to set the cooking end time.



The information screen

- Cooking will start within 10 seconds of no activity, or when the right knob is pressed.
- Rotate the left knob anti-clockwise to go back through the previous setting screens.
- Place food on the middle shelf to achieve the best cooking results.

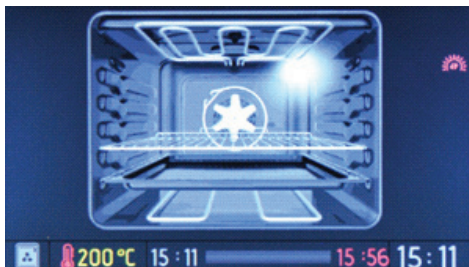

The animation screen

- Press the left knob to stop cooking.
- Press the right knob to start and continue cooking.

- To stop cooking and return to the main menu, press the left knob and rotate it anti-clockwise.

To edit any Favourites settings, follow the steps below.

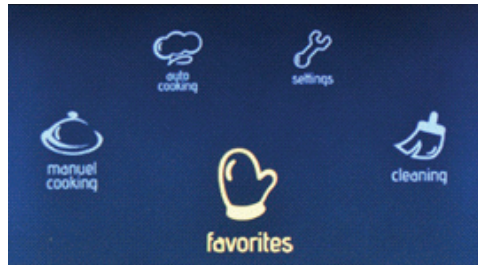

The main menu

- Rotate the right knob in either direction until "Favorites" is highlighted.
- Press the right knob to select the highlighted option.

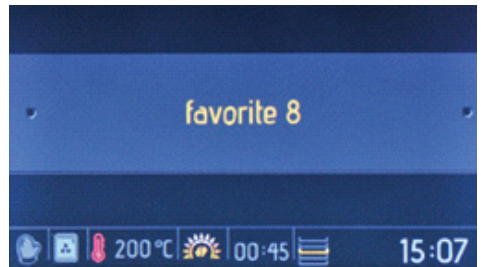

Favourites

- Rotate the right knob in either direction to navigate between the available options.
- Press the right knob to select the highlighted option.
- The settings stored in the selected 'Favourite' will be displayed at the bottom of the screen.

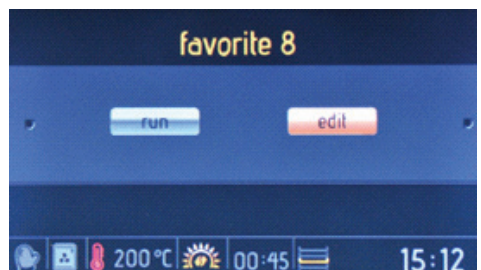

The run/edit screen

- Rotate the right knob to highlight “Edit”.
- Press the right knob to select “Edit”.

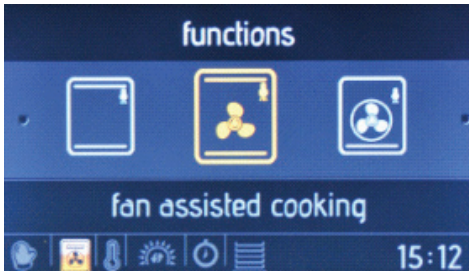

Oven function

- Rotate the right knob in either direction to navigate between the available oven functions.
- Press the right knob to select the highlighted option.



Temperature

- Rotate the right knob in either direction to navigate between the available temperature settings.
- Press the right knob to select the highlighted option.

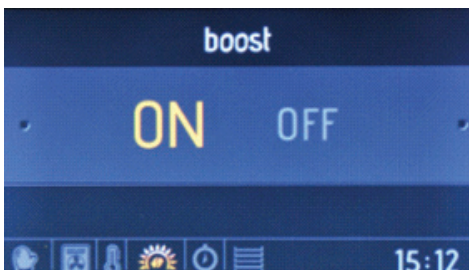

Boost

- Rotate the right knob in either direction to highlight Boost “ON” or “OFF”.
- Press the right knob to select the highlighted option.
- Use this function to heat the oven the desired temperature as quickly as possible. This mode is not appropriate for cooking.



Cooking duration

- Rotate the right knob in either direction to change the cooking duration.
- Press the right knob to set the cooking duration.



Oven shelf

- Rotate the right knob in either direction to navigate between the available oven shelves.
- Press the right knob to select the shelf
- For the same cooking results each time, oven shelf information is important.

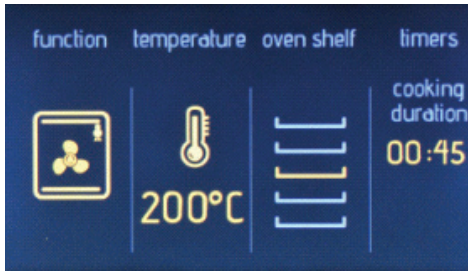

The information screen

- Rotate the left knob anti-clockwise to go back through the previous setting screens.

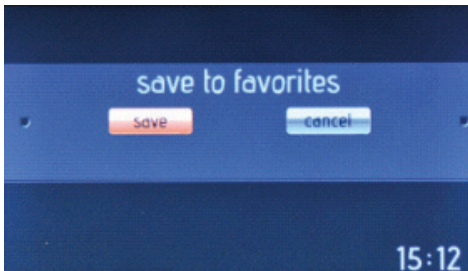

Save to favourites

- Rotate the right knob to highlight “Save” (to save the settings) or “Cancel” (to discard the settings).
- Press the right knob to select the highlighted option.

Cleaning

With the Vapclean function, dried residue within the oven will be softened with vapour. To perform Vapclean, pour a glass of water onto the oven shelf at the bottom of the oven, then follow the steps listed below.

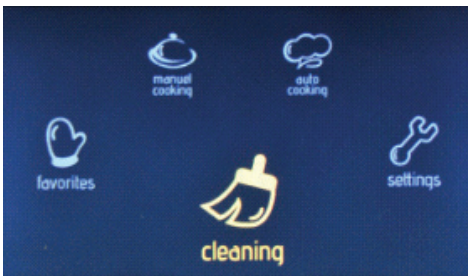

On the main menu

- Rotate the right knob in either direction until “Cleaning” is highlighted.
- Press the right knob to select the highlighted option.

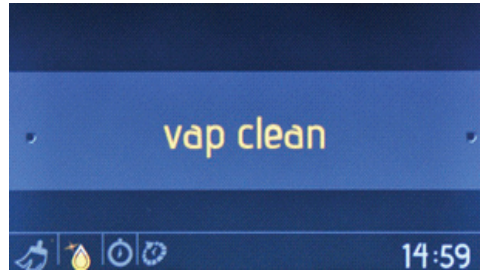

The function selection screen

- Press the right knob to select “Vapclean”.

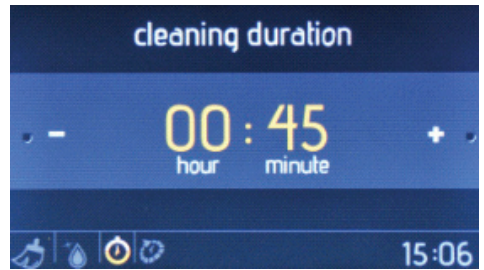

Cleaning duration

- Rotate the right knob in either direction to change the cleaning duration.
- Press the right knob to set the cleaning duration.

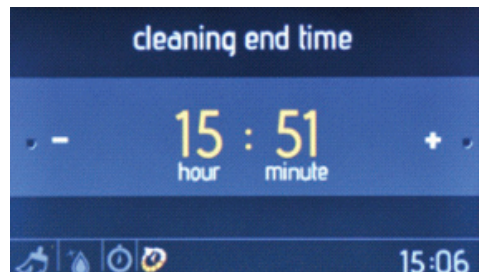

Cleaning end time

- Rotate the right knob in either direction to change the cleaning end time.
- Press the right knob to set the cleaning end time.

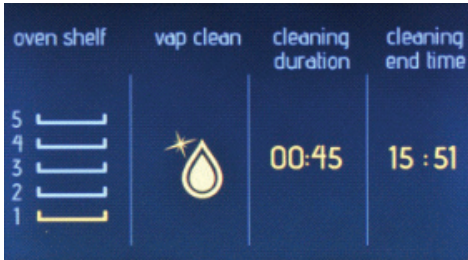

The information screen

- Cleaning will start within 10 seconds of no activity, or when the right knob is pushed.
- Rotate the left knob anti-clockwise to go back through the previous setting screens.



The animation screen

- Press the left knob to stop cleaning.
- Press the right knob to start and continue cleaning.
- To stop cleaning and return to the main menu, press the left knob and rotate it anti-clockwise.

Settings

The settings menu allows you to change and set the date, time, screen brightness, buzzer tone, and language option.

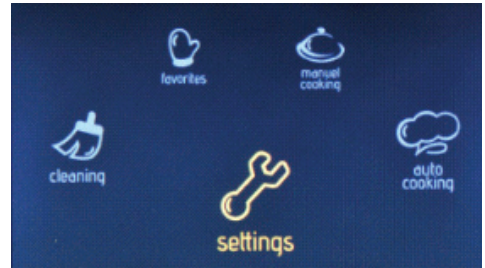

The main menu

- Rotate the right knob in either direction until 'Settings' is highlighted.
- Press the right knob to select the highlighted option.

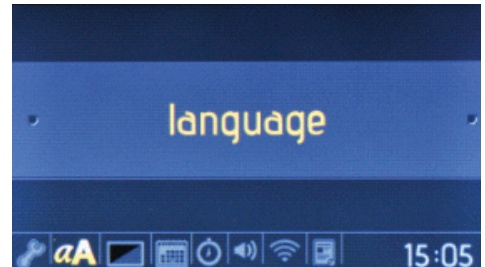

The languages menu

- Rotate the right knob in either direction to change the language.
- Press the right knob to set the desired language.

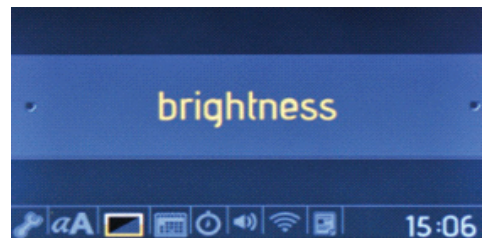

The brightness menu

- Rotate the right knob in either direction to change the screen brightness between the levels 0 and 4.
- Press the right knob to set the screen brightness.

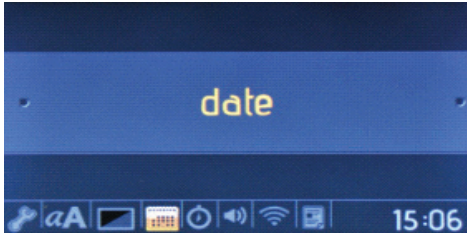

The date menu

- Rotate the right knob in either direction to change the date.
- Press the right knob to set the date.
- The date is set in the format: month, day, year.

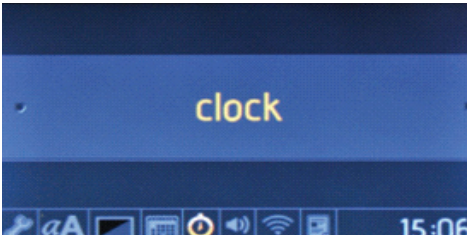

The clock menu

- Rotate the right knob in either direction to change the clock.
- Push the right knob to set the clock.
- Clock is set in the format: minute and hour.

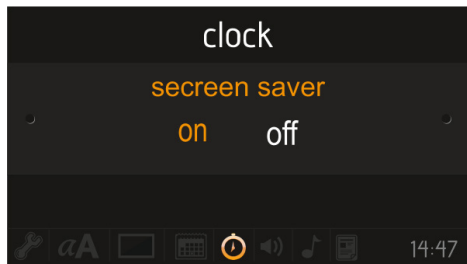

- After setting the clock, screensaver settings menu is shown on the display for standby.
- Rotate the right knob in either direction to highlight Screensaver "ON" or "OFF".
- Press the right knob to select the

highlighted option.

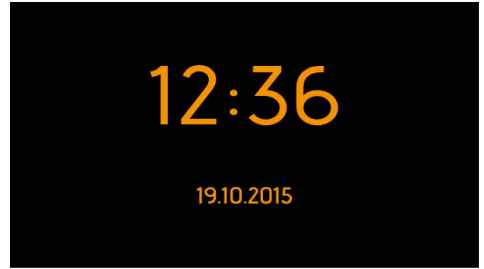

On the buzzer tone menu

- Rotate the right knob in either direction to choose from 3 different buzzer tones.
- Press the right knob to set the desired buzzer tone.

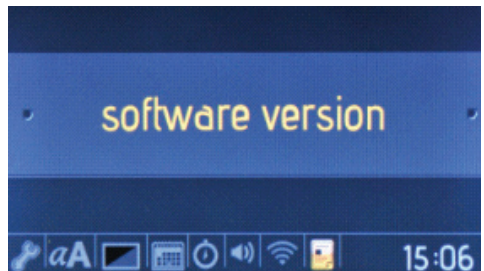

The software version menu

- The software version will be displayed as information only. It cannot be changed.

Key lock

The key lock is used to avoid unintentional changes being made to the oven settings. To activate or deactivate the key lock, rotate the left knob anti-clockwise and hold it for 3 seconds. While the key lock is active, only the "ON/OFF" button can be activated. All other buttons will be locked.

Wifi Setup

With Wi-Fi feature, you can use your oven as a smart home appliance. Wi-Fi feature allows you to access and control your oven remotely. For example, you can switch on your oven at home while you are at the office and control operation mode, temperature and other functions.

To be able to use Wi-Fi feature, a wireless internet provider (wireless modem and etc.), internet connection or a smart phone tablet or a similar device with internet access must be available where your oven is located. You will be able to control your oven with the application you can install to your smart phone or tablet.

WARNING: Internet connection must be active in order to be able to control your oven via Wi-Fi. If the internet connection is switched off or is not active, Wi-Fi will not function since it will not be able to communicate with your oven.

WARNING: Distance between your oven and the device providing internet access such as modem and etc. is decisive in communication between the two devices. The distance is determined by the coverage of the internet device in the house. Communication cannot be established between two devices in places outside or close to the borders of the coverage area where the signal is not available or does not exist.

WARNING: If the setup can not be completed, make sure that Internet modem protocol setting is WPA-2 or WPA-3.

WARNING: If the setup can not be completed, make sure that your Internet speed is set to 2.4 GHZ. (Wifi feature cannot be setup at 5 GHZ Internet connection)

Observe the steps for setup and operation in the following pages to start using your oven via Wi-Fi technology.

Creating a User Profile

Install SHARP HOME application to your smart phone (Android or IOS). You can download the application from Google Play Store or Apple App Store.

Following screen will appear shortly after

you launch SHARP HOME application.

Following screen will appear after SHARP HOME application starts running. Press "Register" to create new user account.

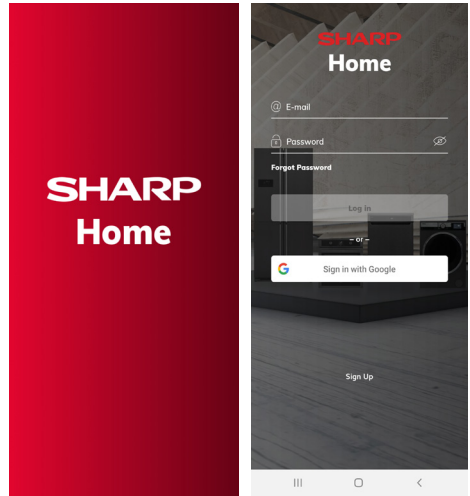

Required information for the new user will be entered by the user.

Enter information, confirm the agreement and press "Continue". New users must accept Terms of Use and Privacy Policy.

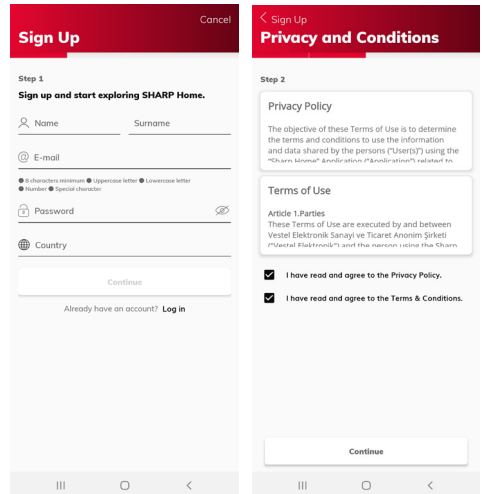

After you accept Terms of Use and Privacy Policy and press "Continue", an activation e-mail will be sent to the e-mail address you have provided while creating your user profile.

Press “Activate my account” in the activation e-mail you have received in your e-mail address to start using the application. You can use your user name and password on your smart phone to login the application.

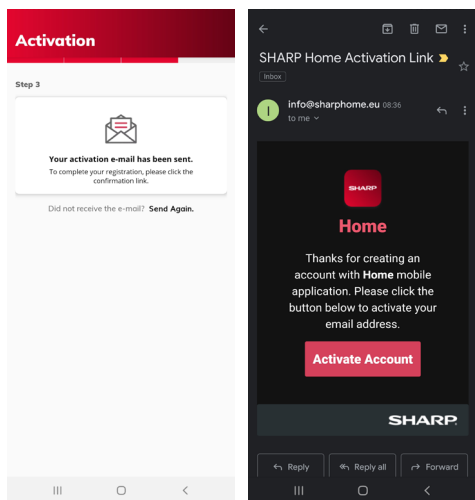

Adding Product to the User Profile Wi-Fi Setup

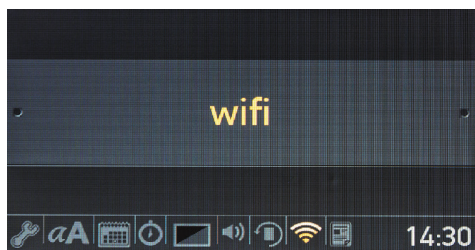

Enter Wifi tab in Settings menu of the oven and select Send.

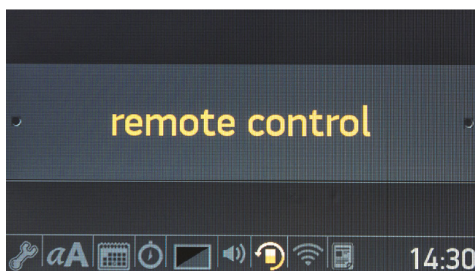

Go to Remote Control tab in Settings menu. Select Yes when “Activate remote control?” appears on the display. Remote control is activated.

Remote control will be disabled when the door is opened and keylock is disabled with left button.

When you login the application, press “+” button to start setting up the appliance you want to use.

Press “Continue” to continue setting up the appliance.

Select “Oven” for appliance type to start setting up your oven.

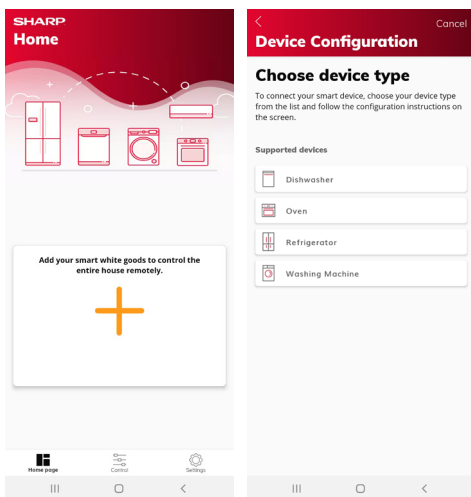

Select the wireless network you want to connect your appliance and press “Continue”.

In the next step you can name your oven as desired.

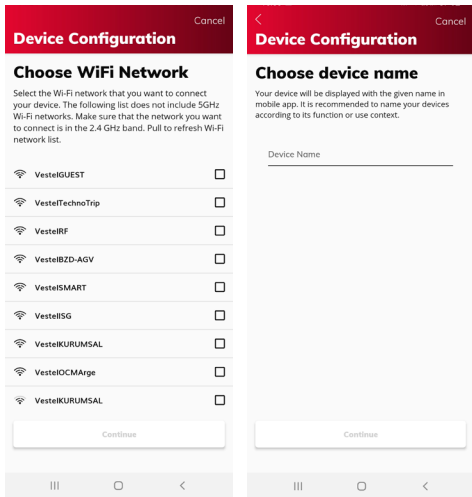

After your appliance is named, establishment of your connection will start.

Warning: If the setup cannot be completed, switch of the mobile data on your smart phone and try again. Make sure that your phone and appliance are connected to the same network.

Congratulations! Setup is complete.

Start the SHARP HOME application. When you login the application, appliances you have setup previously will appear. If your appliance is running, a green dot will appear to indicate that it is active. If remote control is active, select the appliance you want to control from the following menu and then enter the control menu of the appliance.

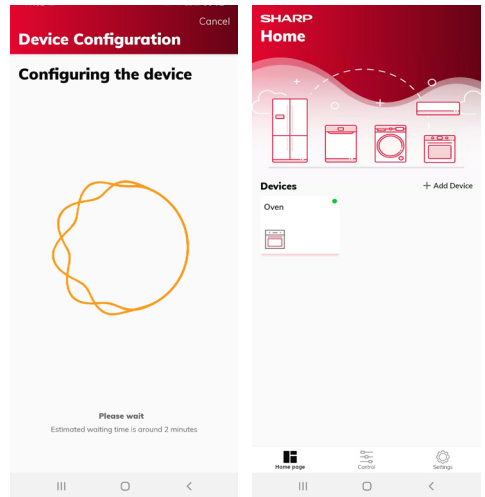

WiFi Control Menu

a- Home Page

You can select cooking functions under “Manuel Control” in the oven control menu. After selecting these cooking functions you can set “Temperature” and “Cooking Time”. After completing your selections you can start cooking with “Start” button.

Recipes Menu

You can obtain perfect results with your SHARP oven by selecting any of the recipes for all tastes from world cuisine prepared by professional chefs.

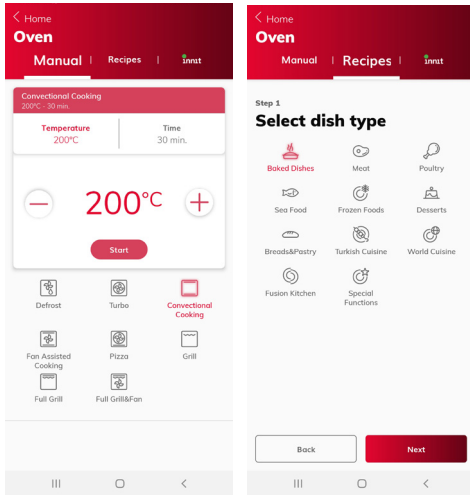

b- Control and Settings

Under “Control” tab you can access the appliance information registered in the application.

Under “Settings” tab, you can access the “Version Info”, “Terms of Use” and “Privacy Policy” of your application.

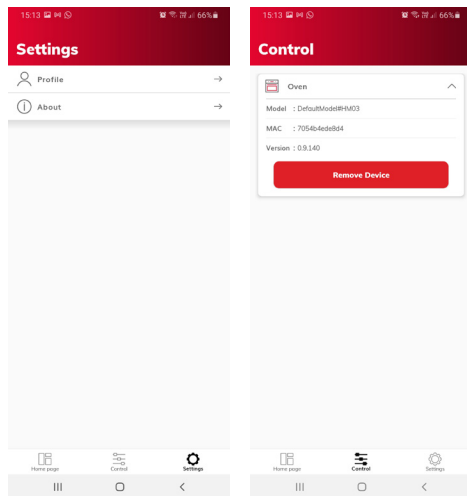

4.4 ACCESSORIES

The EasyFix Wire Rack

Clean the accessories thoroughly with warm water, detergent and a soft clean cloth on first use.

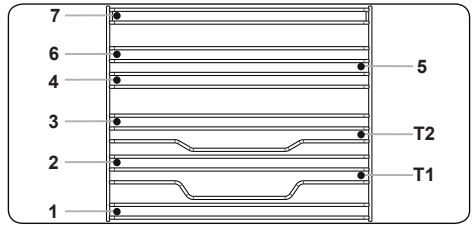

- Insert the accessory to the correct position inside the oven.
- Allow at least a 1 cm space between the fan cover and accessories.
- Take care removing cookware and/or accessories out of the oven. Hot meals or accessories can cause burns.
- The accessories may deform with heat. Once they have cooled down, they will recover their original appearance and performance.
- Trays and wire grids can be positioned on any level from of 1 to 7.
- **Telescopic rail can be positioned on levels T1, T2, 3, 4, 5, 6, 7.**
- Level 3 is recommended for single level cooking.
- Level T2 is recommended for single level cooking with the telescopic rails.
- Level 2 and Level 4 are recommended for double level cooking.
- The turnspit wire grid must be positioned on Level 3.
- Level T2 is used for turnspit wire grid positioning with the telescopic rails.

****Accessories may vary depending on the model purchased.

The Deep Tray

The deep tray is best used for cooking steaks.

Put the tray into any rack and push it to the end to make sure it is placed correctly.

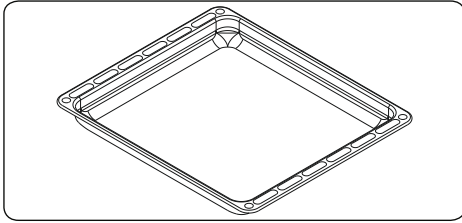

The Grill Pan and Handle Set

The grill pan set is best used for grilling steaks and similar foods.

WARNING: The grill pan has a detachable handle. Make sure when using the grill pan handle that it is centralised and secure, as shown in the figure. Do not leave the handle in position while grilling is in operation.

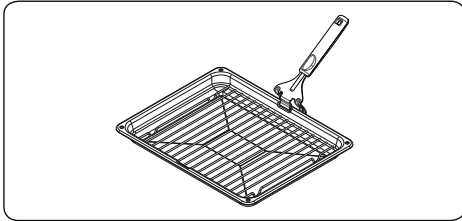

The Rotisserie

1. Loosen the screws on the skewer clamps (b) and pull them off the spit. Push the spit through the chicken, slide the clamps back on, and stick them into the chicken. Tighten the screws.

2. Fit the skewer grid (c) into the appropriate rack.

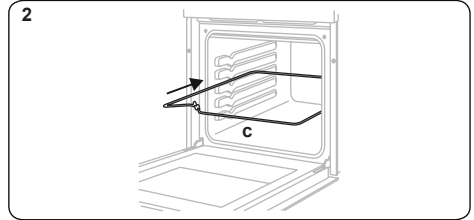
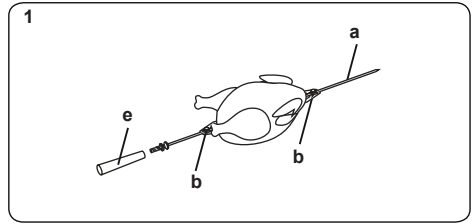

3. Insert the tip of the skewer (a) into the skewer insertion hole (d).

4. Fit the skewer on the skewer grid, remove the handle and close the oven door. The handle (e) must only be attached for removing the chicken after roasting.

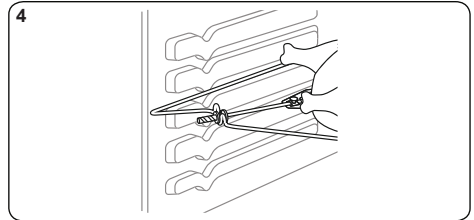
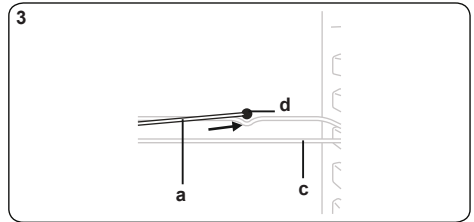

Important: Make sure the oven is not in operation while performing these steps.

Place the grill heat deflector under the control panel if your oven does not support closed-door grilling.

The Shallow Tray

The shallow tray is best used for baking pastries.

Put the tray into any rack and push it to the end to make sure it is correctly placed.

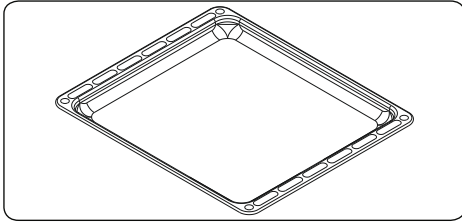

The Small Tray

The small tray is best used for baking pastry.

Place the tray in the centre of a wire grid.

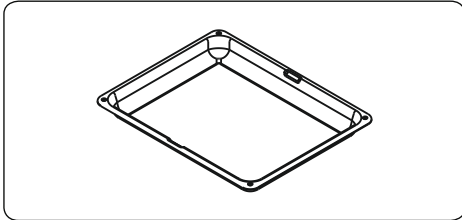

Wire Rack with Easyfix Full Extension Telescopic Rail

The telescopic rail extends out fully to allow easy access to your food.

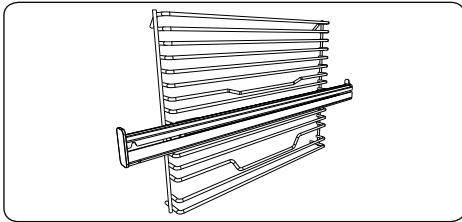

Telescopic rails

Clean the accessories thoroughly with warm water, detergent and a soft clean cloth on first use.

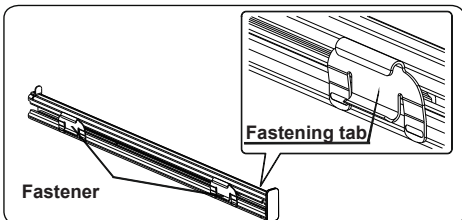

- Positioning of the telescopic rails on the wire rack is secured with the fastening

tabs on the fasteners.

- Remove the side runner. See section "Removal of the wire shelf".

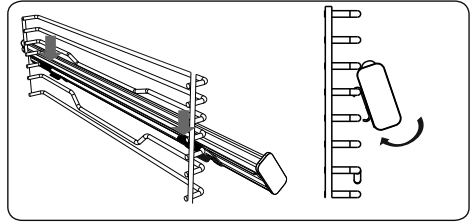

- On each telescopic rail there are top and bottom fasteners that allows you to reposition the rails.
- Hang the telescopic rail top fasteners on the side rack level reference wire and simultaneously press the bottom fasteners until you clearly hear the fasteners clip into the side rack level fixing wire.
- In order to remove, hold the front surface of the rail and follow the previous instructions in reverse.

The Wire Grid

The wire grid is best used for grilling or for processing food in oven-friendly containers.

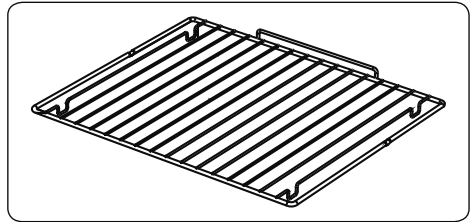

WARNING

Place the grid to any corresponding rack in the oven cavity correctly and push it to the end.

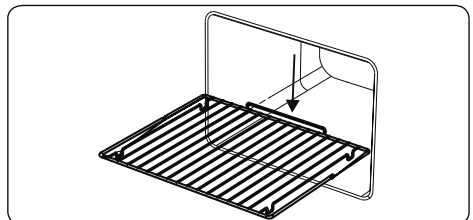

Soft-Close Oven Door

The oven door closes slowly by itself when it is released just before the closed position.

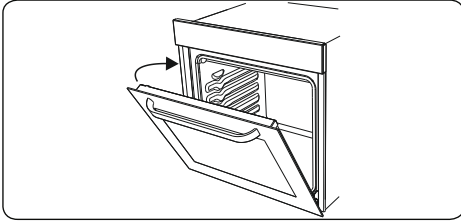

The Water Collector

In some cases of cooking, condensation may appear on the inner glass of the oven door. This is not a product malfunction.

Open the oven door into the grilling position and leave it in this position for 20 seconds.

Water will drip to the collector.

Cool the oven and wipe the inside of the door with a dry towel. This procedure must be applied regularly.

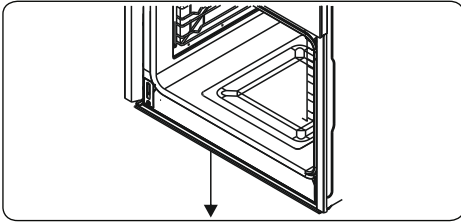

5. CLEANING AND MAINTENANCE

5.1 CLEANING

WARNING: Switch off the appliance and allow it to cool before cleaning is to be carried out.

General Instructions

- Check whether the cleaning materials are appropriate and recommended by the manufacturer before use on your appliance.
- Use cream cleaners or liquid cleaners which do not contain particles. Do not use caustic (corrosive) creams, abrasive cleaning powders, rough wire wool or hard tools as they may damage the cooker surfaces.

 Do not use cleaners that contain particles as they may scratch the glass, enamelled and/or painted parts of your appliance.

- Should any liquids overflow, clean them immediately to avoid parts becoming damaged.

 Do not use steam cleaners for cleaning any part of the appliance.

Cleaning the Inside of the Oven

- The inside of enamelled ovens are best cleaned while the oven is warm.
- Wipe the oven with a soft cloth soaked in soapy water after each use. Then, wipe the oven over again with a wet cloth and dry it.
- You may need to use a liquid cleaning material occasionally to completely clean the oven.

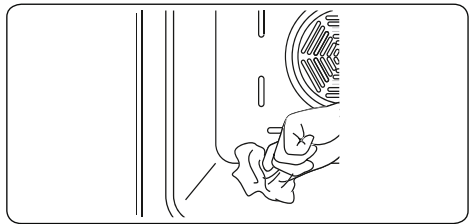

Catalytic Cleaning

Catalytic liners are installed within the oven cavity. These are the matte-finished, light-coloured panels on the sides and/or the matte-finished panel at the rear of the oven. They work by collecting any grease and oil residue during cooking.

The liner self-cleans by absorbing fats and oils and burning them to ash, which can then be easily removed from the floor of the oven with a damp cloth. The lining must be porous to be effective. The liner may discolour with age.

If a large amount of fat is spilled onto the liner it may reduce its efficiency. To overcome this problem, set the oven to maximum temperature for about 20 - 30 minutes. After the oven has cooled, wipe out the floor of the oven.

Manual cleaning of the catalytic liners is not recommended. Damage will occur if a soap-impregnated steel wool pad or any other abrasives are used. In addition, we do not recommend the use of aerosol cleaners on

the liners. The walls of a catalytic liner may become ineffective due to excess grease. The excess grease can be removed with a soft cloth or sponge soaked in hot water, and the cleaning cycle can be carried out as described above.

Removal of the Catalytic Liner

To remove the catalytic liner, remove the screws holding each catalytic panel to the oven.

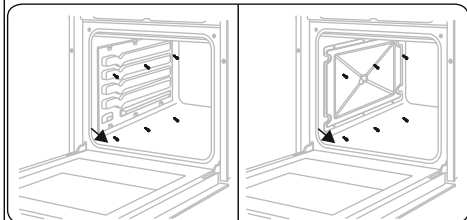



Cleaning the Glass Parts

- Clean the glass parts of your appliance on a regular basis.
- Use a glass cleaner to clean the inside and outside of the glass parts. Then, rinse and dry them thoroughly with a dry cloth.

Cleaning the Stainless Steel Parts (if available)

- Clean the stainless steel parts of your appliance on a regular basis.
- Wipe the stainless steel parts with a soft cloth soaked in only water. Then, dry them thoroughly with a dry cloth.

 Do not clean the stainless steel parts while they are still hot from cooking.

 Do not leave vinegar, coffee, milk, salt, water, lemon or tomato juice on the stainless steel for a long time.

Cleaning Painted Surfaces (if available)

- Spots of tomato, tomato paste, ketchup, lemon, oil derivatives, milk, sugary foods, sugary drinks and coffee should be cleaned with a cloth dipped in warm water immediately. If these stains are not cleaned and allowed to dry on the surfaces they are on, they should NOT be rubbed with hard objects (pointed objects, steel and plastic scouring wires, surface-damaging dish sponge) or cleaning agents containing high levels of alcohol, stain removers, degreasers, surface abrasive chemicals. Otherwise, corrosion may occur on the powder

Painted surfaces, and stains may occur. The manufacturer will not be held responsible for any damage caused by the use of inappropriate cleaning products or methods.

Removal of the Inner Glass

You must remove the oven door glass before cleaning, as shown below.

1. Push the glass in the direction of **B** and release from the location bracket (**x**). Pull the glass out in the direction of **A**.

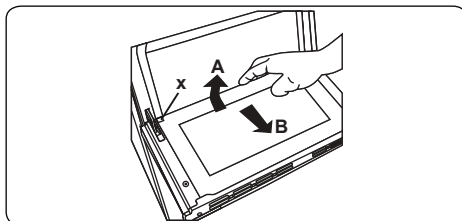

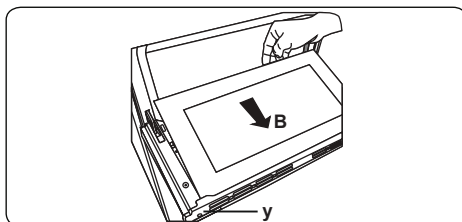

To replace the inner glass:

1. Push the glass towards and under the location bracket (**y**), in the direction of **B**.

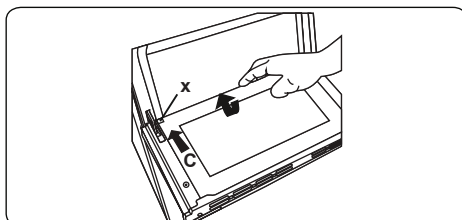

3. Place the glass under the location bracket (**x**) in the direction of **C**.



 If the oven door is a triple glass oven door, the third glass layer can be removed the same way as the second glass layer.

Removal of the Wire Shelf

To remove the wire rack, pull the wire rack as shown in the figure. After releasing it from the clips (**a**), lift it up.

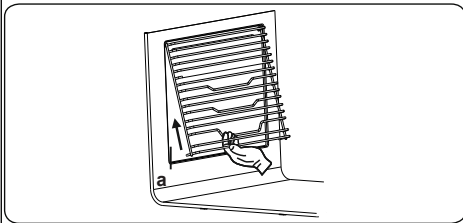

5.2 MAINTENANCE

! **WARNING:** The maintenance of this appliance should be carried out by an authorised service person or qualified technician only.

Changing the Oven Lamp

! **WARNING:** Switch off the appliance and allow it to cool before cleaning your appliance.

- Remove the glass lens, then remove the bulb.
- Insert the new bulb (resistant to 300 °C) to replace the bulb that you removed (230 V, 15-25 Watt, Type E14).
- Replace the glass lens, and your oven is ready for use.

! The lamp is designed specifically for use in household cooking appliances. It is not suitable for household room illumination.

6. TROUBLESHOOTING&TRANSPORT

6.1 TROUBLESHOOTING



If you still have a problem with your appliance after checking these basic troubleshooting steps, please contact an authorised service person or qualified technician.

Problem	Possible Cause	Solution
Oven does not switch on.	Power is switched off.	Check whether there is power supplied. Also check that other kitchen appliances are working.
No heat or oven does not warm up.	Oven temperature control is incorrectly set. Oven door has been left open.	Check that the oven temperature control knob is set correctly.
Oven light (if available) does not operate.	Lamp has failed. Electrical supply is disconnected or switched off.	Replace lamp according to the instructions. Make sure the electrical supply is switched on at wall socket outlet.
Cooking is uneven within the oven.	Oven shelves are incorrectly positioned.	Check that the recommended temperatures and shelf positions are being used. Do not frequently open the door unless you are cooking things that need to be turned. If you open the door often, the interior temperature will be lower and this may affect the results of your cooking.
The timer buttons cannot be pressed properly.	There is foreign matter caught between the timer buttons. Touch model: there is moisture on the control panel. The key lock function is set.	Remove the foreign matter and try again. Remove the moisture and try again. Check whether the key lock function is set.
The oven fan (if available) is noisy.	Oven shelves are vibrating.	Check that the oven is level. Check that the shelves and any bake ware are not vibrating or in contact with the oven back panel.
The cooling fan continues to operate after the oven is switched off.	Electronically-controlled oven fan automatically runs for a certain amount of time to cool the oven.	The fan switches off automatically when the electronic components have cooled sufficiently.
The oven has switched itself off.	Electronically-controlled ovens switch off automatically if no function is in operation.	The oven will switch itself off automatically to save energy if no other action is taken within a certain time frame after switching it on or after the end of a cooking programme.
If the door is opened during a fan-assisted function, the internal fan will stop.	Electronically-controlled ovens with a door switch will stop cooking if the oven door is opened.	It is a normal operation of the appliance, useful when cooking foods in order to avoid excessive heat escaping. When the door is closed, the oven will restart to normal operation.

6.2 TRANSPORT

If you need to transport the product, use the original product packaging and carry it using its original case. Follow the transport signs on the packaging. Tape all independent parts to the product to prevent damaging the product during transport.

If you do not have the original packaging, prepare a carriage box so that the appliance, especially the external surfaces of the product, is protected against external threats.

7. TECHNICAL SPECIFICATIONS

7.1 ENERGY FICHE

Brand		
Model		KS-76S50BNP-EU
Type of Oven		ELECTRIC
Mass	kg	38,5
Energy Efficiency Index - conventional		1057
Energy Efficiency Index - fan forced		94,3
Energy Class		A
Energy consumption (electricity) - conventional	kWh/cycle	0,93
Energy consumption (electricity) - fan forced	kWh/cycle	0,83
Number of cavities		1
Heat Source		ELECTRIC
Volume	l	78
This oven complies with EN 60350-1		

Energy Saving Tips

Oven

- Cook the meals together, if possible.
- Keep the pre-heating time short.
- Do not elongate cooking time.
- Do not forget to turn-off the oven at the end of cooking.
- Do not open oven door during cooking period.



Service & Support

Visit Our Website

sharphomeappliances.com

52333148

SHARP

Be Original.