



# QW-GS53I443X-DE

Dishwasher

EN User Manual



# CONTENTS

<b>CHAPTER-1: EXPLANATION OF PRODUCT</b>	
Technical specifications .....	5
Conformity with the standards and test data .....	5
<b>CHAPTER-2: SAFETY INFORMATION AND RECOMMENDATIONS</b>	
Recycling .....	6
Safety information .....	6
Recommendations .....	8
Items not suitable for dishwashing .....	8
<b>CHAPTER-3: INSTALLING THE MACHINE</b>	
Positioning the machine .....	8
Water connections .....	9
Water inlet hose .....	9
Water outlet hose .....	9
Electrical connection .....	10
Prior to using the machine .....	11
<b>CHAPTER-4: PREPARING THE MACHINE FOR USE</b>	
The importance of water decalcification .....	11
Filling with salt .....	11
Testing strip .....	11
Adjusting salt consumption .....	12
Detergent usage .....	12
Filling the detergent compartment .....	12
Combined detergent .....	13
Filling with rinse aid and making the setting .....	13
<b>CHAPTER-5: LOADING YOUR DISHWASHER</b>	
Dish rack .....	14
Alternative basket loads .....	16
<b>CHAPTER -6: PROGRAMME DESCRIPTIONS</b>	
Programme items .....	17
<b>CHAPTER -7: SWITCHING ON THE MACHINE AND SELECTING A PROGRAMME</b>	
Switching on the machine .....	20
Programme follow-up .....	20
Changing a programme .....	21
Changing a programme with resetting .....	21
Switching the machine off .....	21
<b>CHAPTER-8: MAINTENANCE AND CLEANING</b>	
Filters .....	23
Spray arms .....	23
Hose filter .....	23
<b>CHAPTER-9: FAILURE CODES AND WHAT TO DO IN CASE OF FAILURE</b>	<b>24</b>
<b>CHAPTER-10: PRACTICAL AND USEFUL INFORMATION</b>	<b>25</b>

Dear Customer, our goal is to offer you, high quality products that exceed your expectations. Your appliance is produced in modern facilities and is carefully tested for quality.

Before using your appliance, carefully read this guide which includes basic information for safe installation, maintenance and use.

The operating instructions apply to several models. Differences may therefore occur.

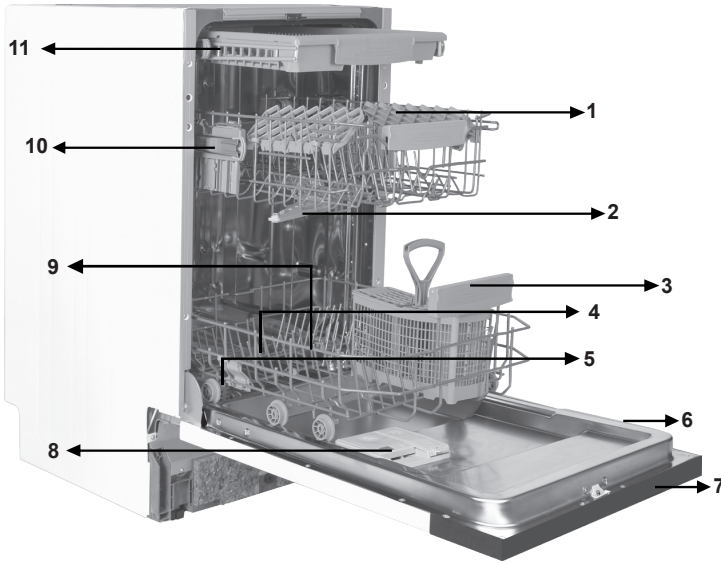

- 1. Upper basket with racks
- 2. Upper spray arm
- 3. Lower basket
- 4. Lower spray arm
- 5. Filters
- 6. Rating plate

- 7. Control panel
- 8. Detergent and rinse aid dispenser
- 9. Salt dispenser
- 10. Upper basket track latch
- 11. Upper cutlery basket

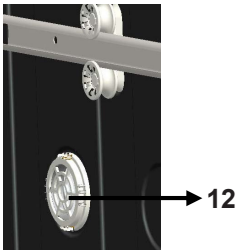

**Turbo Drying Unit:**  
This system provides better drying performance for your dishes.

## CHAPTER -1: TECHNICAL SPECIFICATIONS

### Technical specifications

Capacity	10 place settings
Height	820 mm - 870 mm
Width	450 mm
Depth	550 mm
Net Weight	32 kg
Electricity input	220-240 V, 50 Hz
Total Power	1900 W
Heating Power	1800 W
Pump Power	100 W
Drain Pump Power	30 W
Water supply pressure	0.03 MPa (0,3 bar)-1 MPa (10 bar)
Current	10 A

### Conformity with the standards and Test data / EU Declaration of Conformity

This product meets the requirements of all applicable EU directives with the corresponding harmonised standards, which provide for CE marking.

Please visit [www.sharphomeappliances.com](http://www.sharphomeappliances.com) for an electronic copy of this user manual.

### SAFETY INFORMATION AND RECOMMENDATIONS

#### Recycling

- The recyclable materials are used in certain components and packaging.
- Plastic parts are marked with international abbreviations: (>PE< , >PS< , >POM< , >PP< , )
- Cardboard parts have been produced from recycled paper which should be disposed of into waste paper collection containers for recycling.
- Such materials are not suitable for garbage bins. They should be delivered to recycling centres instead.
- Contact relevant centres in order to obtain information on methods and points of disposal.

#### Safety Information

##### When you take delivery of your machine

- If you see any damage on your machine's packaging, please contact the authorised service.
- Unwrap the packaging materials as indicated and dispose of them in accordance with the rules in force.

##### Points to pay attention during machine installation

- Choose a suitable, safe and level place to install your machine.
- Carry out the installation and connection of your machine by following the instructions.
- This machine should only be installed and repaired by an authorised service technician.
- Only original spare parts should be used with the machine.
- Before installing, be sure that the machine is unplugged.
- Check whether the indoor electrical fuse system is connected according to the regulations.
- All electrical connections must match the values on the rating plate.
- Be sure that the machine does not stand on the electricity supply cable.
- Never use an extension cord or a multiple socket for making a connection. The plug should be comfortably accessible after installation.
- After installation, run it unloaded for the first time.

##### In daily use

- This machine is for household use; do not use it for any other purpose. Commercial usage of the dishwasher will void the warranty.
- Do not get up, sit or place a load when the door is open, it may fall over.
- Never use a detergent and rinse agent which is not produced specifically for dishwashers. Our company will not be liable for this.
- The water in the machine's washing section is not drinking water. Do not drink it.
- Due to danger of explosion, do not put any chemical dissolving agents such as solvents into the machine's washing section.

## CHAPTER -2: SAFETY INFORMATION AND RECOMMENDATIONS

- Check whether plastic items are heat-resistant before washing.
- This appliance can be used by children aged 8 years and over and persons with reduced physical, sensory or mental capabilities or lack of experience and knowledge if they have been given supervision or instruction concerning use of the appliance in a safe way and understand the hazards involved. Children shall not play with the appliance. Cleaning and user maintenance should not be carried out by children without supervision.
- Do not put unsuitable and heavy items above the baskets capacity into your machine. Our company will not be liable for any damage on the internal parts.
- The door must not open while the machine is operating. In any case, the safety device ensures that the machine stops if the door is opened.
- Do not leave the door open, to avoid accidents.
- Place knives and other sharp-ended objects in the cutlery basket in blade-down position.
- If the supply cord is damaged, it must be replaced by the manufacturer, its service agent or competent technician in order to prevent a hazard.
- If the Energy Save option is selected as “Yes”, The door will be opened at the end of the programme. Do not force the door shut to avoid harm to the auto door mechanism for 1 minute. The door must be open for 30 minutes for effective drying.(in models with an auto door opening system)

**Warning:** Do not stand in front of the door after the signal for the auto-open sounds.

### **For your children's safety**

- After removing the machines packaging, make sure that the packaging material is out of reach of children.
- Do not allow children to play with or start the machine.
- Keep children away from detergents and rinse agents.
- Keep children away from the machine while it is open as there may still be cleaning substance residues inside the machine.
- Be sure that your old machine does not pose any threat to your children. Children are known to have gotten themselves locked in old machines. To prevent such a situation, break your machines doorlock and tear off the electrical cables.

### **In case of malfunctioning**

- Any repairs performed by anyone other than authorized service staff will result out of scope warranty to your machine.
- Prior to any repair work on the machine, be sure that the machine is cut off from the power supply. Switch off the fuse or unplug the machine. Do not pull by the cable when unplugging. Make sure to turn off the water tap.

### Recommendations

- For energy and water saving, remove coarse residues on your dishes before placing the dishes into the machine. Start your machine after having fully loaded it.
- Use the pre-wash programme only whenever necessary.
- Place such hollow items as bowls, glasses and pots into the machine in such a way so they face down.
- You are recommended not to load into your machine any dishes different or more than indicated.

### Items not suitable for dish washing:

- Cigarette ashes, candle wax, polish, paint, chemical substances, iron-alloy materials;
- Forks, spoons and knives with wooden, bone, ivory or nacre-coated handles; glued items, items soiled with abrasive, acidic or base chemicals.
- Plastic items that are not heat-resistant, copper or tin-coated containers.
- Aluminium and silver objects (they may discolour, become dull).
- Certain delicate glass types, porcelains with ornamental printed patterns as they fade even after the first wash; certain crystal items as they lose their transparency over time, adhered cutlery that is not heat-resistant, lead crystal glasses, cutting boards, items manufactured with synthetic fibres;
- Absorbent items such as sponges or kitchen rags are not suitable for dishwashing.

**Warning:** Make sure to purchase dishwasher-safe sets in your future purchases.

## INSTALLING THE MACHINE

### Positioning the machine

When determining the installation place, ensure an accessible place for easy loading and unloading of dishes.

Do not put your machine in any location where there is a probability of the room temperature falling below 0°C.

Before positioning, take the machine out of its packaging by following the warnings located on the packaging.

Position the machine close to a water tap or drain. You need to site your machine, taking into consideration that its connections cannot be altered once they are made.

Do not grip the machine by its door or panel in order to move it.

Take care to leave sufficient clearance from all sides of the machine to comfortably move it back and forth during cleaning. Make sure that the water inlet and outlet hoses do not get squeezed while positioning the machine.

Also, make sure that the machine does not stand on the electrical cable.

Adjust the machine's adjustable feet so that it can stand level and balanced.

The proper positioning of the machine ensures problem-free opening and closing of the door.



## CHAPTER -3: INSTALLING THE MACHINE

If the door of the machine does not close properly, check if the machine is stable on the floor on which it stands; if not, adjust the feet and ensure its stable position.

### Water connection

Indoor plumbing must be suitable for installing a dishwasher. We also recommend that you fit a filter at the entrance of your house or apartment so as to avoid any damage to your machine as a result of any contamination (sand, clay, rust etc.) that might be occasionally carried in through the main water supply or the indoor plumbing, and to forestall such complaints as yellowing and the formation of deposits after washing.

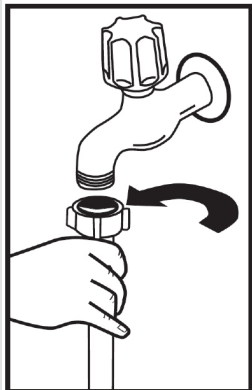

### Water inlet hose

Do not use the water inlet hose of your old machine. Use the new hose supplied with your machine. If you connect a new or long - unused water inlet hose to your machine, run water through it for a while before making the connection. Connect the water inlet hose directly to the water inlet tap. The pressure supplied by the tap should be at a minimum of 0.03 Mpa and at a maximum of 1 Mpa. If the water pressure is above 1 Mpa, a pressure-relief valve should be fitted in between.

After making connections, the tap should be turned on fully and checked for water tightness. For the safety of machine, turn off the water inlet tap after finishing each wash programme.

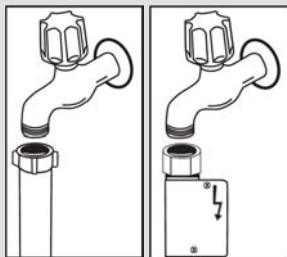

**NOTE:** An aquastop water spout is used in some models. In the event of using Aquastop, a dangerous tension exists. Do not cut Aquastop water spout. Do not let it get folded or twisted.

### Water outlet hose

The water drain hose can be connected either directly to the water drain hole or to the sink outlet spigot. Using a special bent pipe (if available), the water can be drained directly into the sink via hooking the bent pipe over the edge of the sink. This connection should be between 50 and 110 cm from the floor plane.

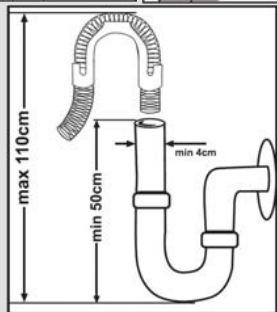

## CHAPTER -3: INSTALLING THE MACHINE

**Warning:** When a drain hose longer than 4 m is used, the dishes may remain dirty. In such a case, our company will not accept liability.

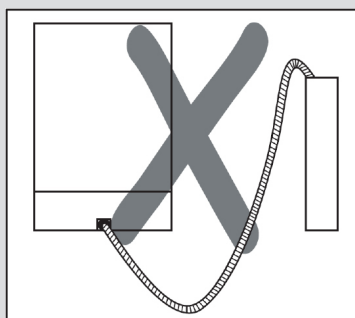
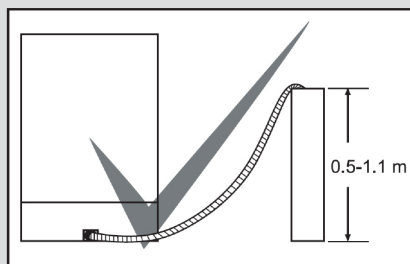

### Electrical connection

The grounded plug of your machine should be connected to an grounded outlet supplied by a suitable voltage and current. If there is no grounding installation, have a competent electrician carry one out. In the event of usage without installed grounding, our company will not be liable for any loss of usage that may occur.

The indoor fuse current value should be 10-16 A.

Your machine is set to 220-240 V. If the power supply voltage in your location is 110 V, connect a transformer of 110/220 V and 3000 W in between. The machine should not be plugged in during positioning.

Always use the coated plug supplied with your machine.

Operation in low voltage will cause a decline in washing quality.

The machine's electrical cable should be replaced by an authorised service or an authorised electrician only. Failure to do so may lead to accidents.

For safety purposes, always make sure to disconnect the plug when a wash programme is finished.

In order to avoid an electric shock, do not unplug when your hands are wet. When disconnecting your machine from the main supply, always remove by the plug. Never pull on the cord itself.

## CHAPTER -4: PREPARING THE MACHINE FOR USE

### Prior to using the machine for the first time

- Check whether the electricity and supply water specifications match the values indicated by the installation instructions for the machine.
- Remove all packaging materials inside the machine.
- Set the water softener.
- Add 1 kg salt into the salt compartment and fill with water up to a level at which it will almost overflow.
- Fill the rinse aid compartment.

### PREPARING THE MACHINE FOR USE

#### The importance of water decalcification

For a good washing function, the dishwasher needs soft, i.e. less calcareous water. Otherwise, white lime residues will remain on the dishes and the interior equipment. This will negatively affect your machine's washing, drying and shining performance. For this reason, a softener system used on dishwashers. The softener system has to be refreshed so that it operates with the same performance also during the next wash. For this purpose, dishwasher salt is used.

#### Filling with salt (IF AVAILABLE)

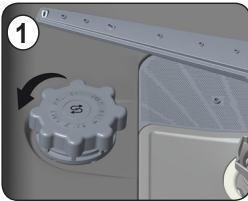

Use softener salt specifically produced for use in dishwashers. To add softener salt, first remove the lower basket and then open the salt compartment cap by turning it counter clockwise. (1) (2) At first use fill the compartment with 1kg salt and water (3) at overflowing level if available. Using a funnel (4) will make filling easier. Refill the cap and close it. After every 20th-30th wash, add salt into your machine until it fills up (approx. 1 kg) Fill the salt compartment with water at first use only. We recommend to use smallgrained or powder softener salt. Do not put table salt into your machine. Otherwise, the function of the softener compartment may decrease over time. When you start machine, the salt compartment gets filled with water. There fore, put the softener salt prior to starting your machine. This way, overflowing salt gets immediately cleaned up through the wash operation. If you will not wash any dishes immediately after putting salt, then run a short washing program with an empty machine in order to avoid corrosion on your machine due to the salt overflow while filling in the salt container. In order to understand whether or not the amount of

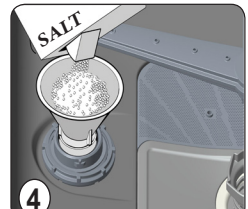
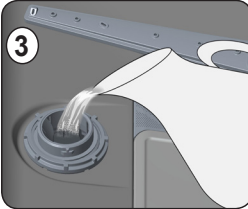
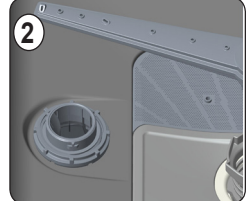

softener salt in machine is sufficient, check the transparent section on the salt compartment cap. There is sufficient salt if the transparent section is green. Salt has to be added if it is not green.

#### Testing strip

The washing effectiveness of your machine depends on the softness of the tap water. For this reason, your machine is equipped with a system that reduces the hardness in mains water supply. The washing effectiveness will increase when the system is correctly set. To find out the water hardness level of water in your area, contact your local water board or determine water hardness level by using the test strip(if available).

Open the testing strip	Run water through your tap for 1 min.	Keep the testing strip in water for 1.sec.	Shake the testing strip after taking it out of water	Water for 1 min.	Make your machine's water hardness setting according to the result obtained through the testing strip.
					Level 1 Level 2 Level 3 Level 4 Level 5 Level 6
					No Lime
					Very low lime content
					Low lime content
					Medium lime content
					Lime content
					High lime content

## CHAPTER -4: PREPARING THE MACHINE FOR USE

### Adjusting salt consumption

Water hardness level	German hardness level dH	French hardness level dF	British hardness level dE	Hardness Level Indicator
1	0-5	0-9	0-6	L1 is seen on display.
2	6-11	10-20	7-14	L2 is seen on display.
3	12-17	21-30	15-21	L3 is seen on display.
4	18-22	31-40	22-28	L4 is seen on display.
5	23-31	41-55	29-39	L5 is seen on display.
6	32-50	56-90	40-63	L6 is seen on display.

Adjust the water hardness setting of your machine according to the level specified on the test strip.

**NOTE:** Hardness level is adjusted to level 3 as a factory setting.

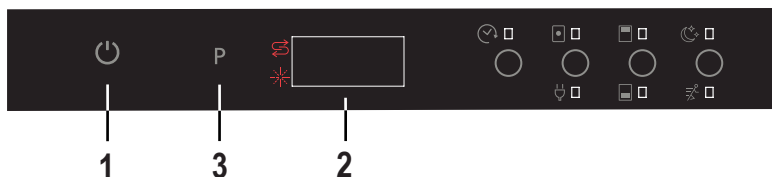

After resting the machine, with the door open;

While touching the program button (3) turn on the machine with the power button.(1)

Continue to touch the program button until "SL" appears on the display. (2)

Release the program touch button when "SL" disappears from the display. (2)

The current water hardness setting will appear on the display. (2)

Press the program touch button (3) to select the desired level according to Table of Water Hardness Level Settings.

At any pressure on the program touch button (3) will increment the hardness level.

The level changes from Level 6 to Level 1 when the program button (3) is pressed.

To save the setting to memory, power off the machine. (1)

### Detergent usage

Use a detergent specifically designed for use in domestic dishwashers.

You can find powder, gel, and tablet detergents that have been designed for household dishwashers.

Detergent should be put into the compartment prior to starting the machine. Keep your detergents in cool, dry places out of reach of your children.

Do not overfill the detergent compartment; otherwise it may cause scratches on your glasses as well as lead to a poorly dissolved detergent.

Should you need more information concerning the detergent you will use, contact the detergent manufacturers directly.

### Filling the detergent compartment

Push the latch to open the detergent container as shown in the image. 1 The Detergent pod has level lines inside. The Detergent pod can take a total of 40 cm<sup>3</sup> of detergent. Open the dishwasher detergent and pour into the larger compartment b 25 cm<sup>3</sup> if dishes are heavily soiled or less 15 cm<sup>3</sup>. 2 If dishes have been kept dirty for a very long time with, dried food waste on them or the dishwasher has been overloaded pour a 5cm<sup>3</sup> of detergent into the prewash compartment and start the machine. You may have to add more detergent into your machine, depending on the degree of soil and on the water hardness level in your area.

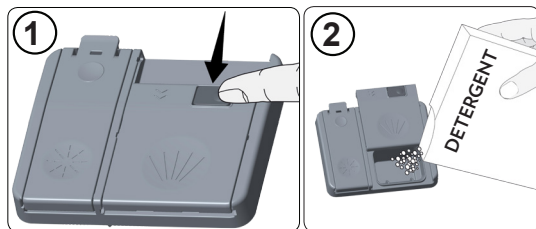

## CHAPTER -4: PREPARING THE MACHINE FOR USE

### Combined detergents

Combined detergents may include various properties in them. Before using a detergent, please read and follow the instructions well. Generally, combined detergents produce sufficient results only under certain conditions.

#### Points to consider when using these types of products:

- Check the specifications of the product whether it is combined or not.
- Check if the detergent used is appropriate for the hardness of the main water supply.
- Read the instructions of the products on the packagings.
- Always put the tablets into the detergent compartment in the detergent dispenser.
- You need to contact the manufacturers and find out about the suitable conditions of use.
- If you use appropriate products, they can ensure savings in salt and/or rinse agent consumption.
- The scope of the warranty for your machine does not cover any complaints caused by the use of these types of detergents.

**Recommended usage:** If you want to obtain better results while using combined detergents, add salt and rinse agent into your machine and adjust the water hardness setting and the rinse aid setting to the lowest position.



The solubility of the tablet detergents produced by different companies can vary depending on the temperature and time. Therefore, the use of such detergents in short programmes is not recommended. It is more suitable to use powder detergents for such programmes.

**Warning:** Should any problem, which you have not encountered before arise with the use of this type of detergents, contact the detergent manufacturers directly.

#### When you stop using combined detergents

- Fill the salt and rinse agent compartments.
- Adjust the water hardness setting to the highest position and run an empty-wash.
- Adjust the water hardness level.
- Set the suitable rinse agent setting.

#### Filling with rinse agent and making the setting

To fill the rinse aid compartment, open the rinse-aid compartment cap. Fill the compartment with rinse aid to the MAX level and then close the cap. Be careful not to overfill the rinse aid compartment and wipe up any spills.

**In order to change the rinse aid level, follow the below steps before turning on the machine:**

- Touch the programme button and hold it down.
- Turn on the machine.
- Hold down the programme button until “rA” disappears. Rinse aid set follows water hardness set.
- The machine will display the current setting.
- Set the level by touching the programme button.
- Switch off the machine to save the setting.

The factory setting is “4”.

If the dishes are not drying properly or are spotted, increase the level. If blue stains form on your dishes, decrease the level.

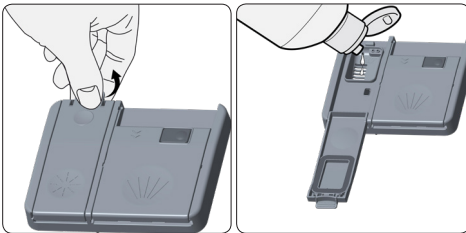

Level	Brightener Dose	Indicator
1	Rinse-aid not dispensed	r1 is shown on the display
2	1 dose is dispensed	r2 is shown on the display
3	2 doses are dispensed	r3 is shown on the display.
4	3 doses are dispensed	r4 is shown on the display.
5	4 doses are dispensed	r5 is shown on the display.

## CHAPTER-5: LOADING YOUR DISHWASHER

### LOADING YOUR DISHWASHER

Place dishes properly into the machine.

There are two separate baskets to load dishes into your machine. The lower basket is for round and deep items. The upper basket is for thin and narrow items. You are recommended to use the cutlery basket in order to obtain the best result.

To avoid any possible injuries, place long-handle and sharp-pointed knives with their sharp points facing down or horizontally on the baskets.

**Warning:** Place your dishes into your machine in a way that they will not prevent the upper and lower spray arms from spinning.

#### Dish rack

There are dish racks on the upper basket of your machine. **a b** You can use these dish racks in open or closed position. When they are in open position **a** you can place your cups on them; and when in closed position **b** you can place long glasses on the basket. Also, you can use these racks by placing long forks, knives and spoons on them laterally.

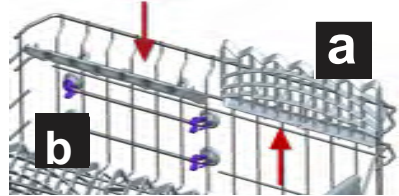

#### Folding Racks

Foldable racks on the upper basket are designed in order to let you place big items easier such as pots, pans, etc. If requested, each part can be folded separately, or all of them can be folded and larger spaces can be obtained. You can use foldable racks by raise them upwards, or by folding down.

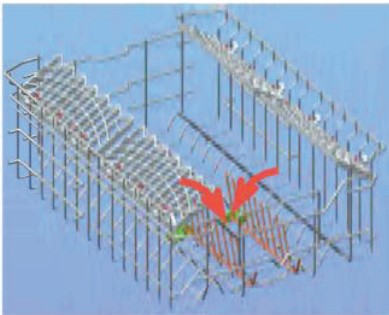

## CHAPTER-5: LOADING YOUR DISHWASHER

### Top basket height adjustment while it is full

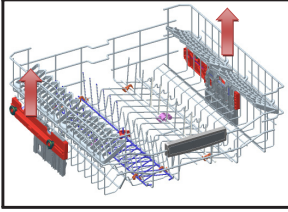

The basket height adjustment mechanism on the top basket of your machine is designed to let you adjust the height of your top basket upwards or downwards, without removing it from your machine when it is full, and create large spaces at the top or bottom area of your machine as needed. The basket of your machine is set to the upper position in factory settings. In order to raise your basket, hold it from both sides and pull it upwards. In order to lower it, hold it from both sides again, and leave it. In the loaded basket adjustment mechanism, make sure that both sides are in the same position (up or down).

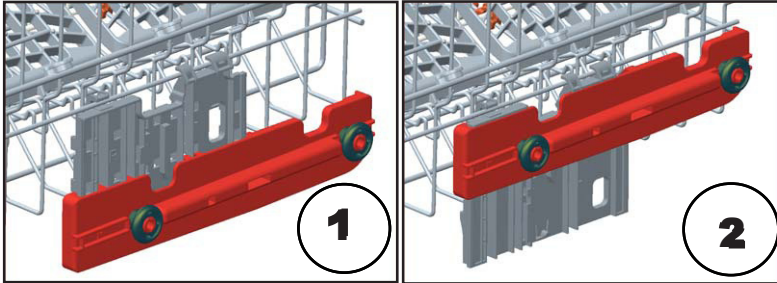

### Lower Basket Folding Racks

Folding racks consisting of two parts that are located on the lower basket of your machine are designed in order to let you place big items easier such as pots, pans, etc. If requested, each part can be folded separately, or all of them can be folded and larger spaces can be obtained. You can use folding racks by raising them upwards, or by folding them down.

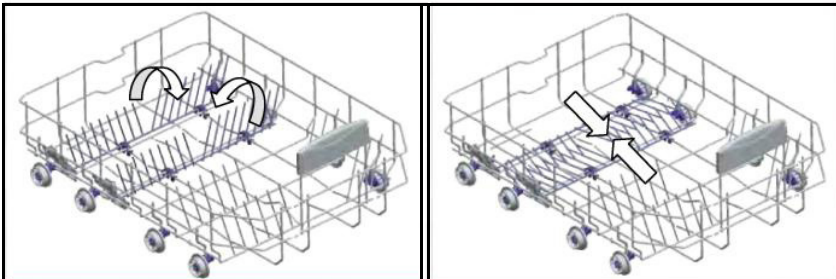

## CHAPTER-5: LOADING YOUR DISHWASHER

### Upper Cutlery Basket

The upper cutlery basket is designed for you to place forks, spoons and knives, long dippers and small items.

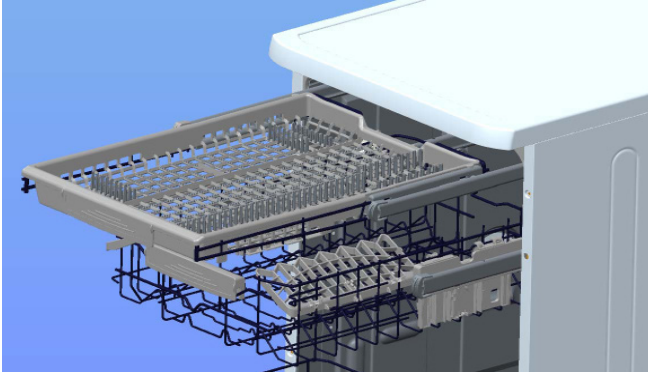

Because it can easily be taken out of the machine, it allows your dishes to be taken out of the machine along with the basket after washing.

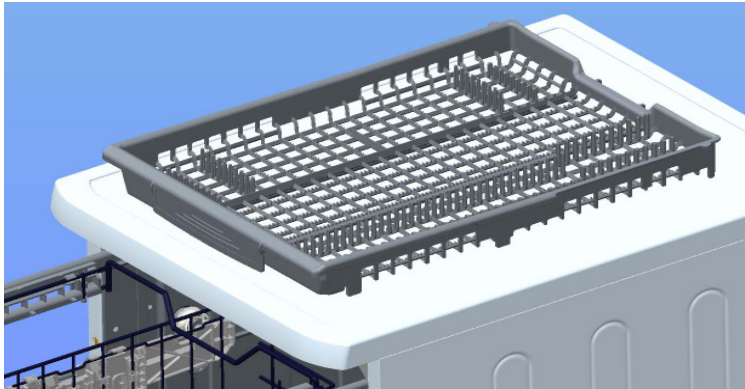

**Warning:** Knives and other sharp objects must be placed horizontally in the cutlery basket.



## CHAPTER-5: LOADING YOUR DISHWASHER

Alternative basket loads  
Lower Basket



Top basket



## CHAPTER-5: LOADING YOUR DISHWASHER

### Faulty loads

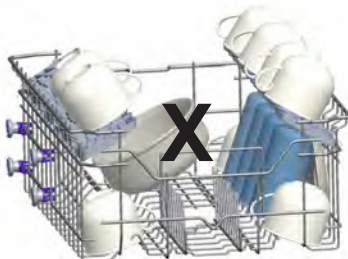
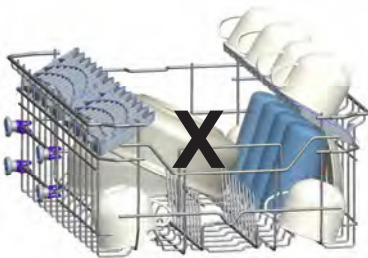
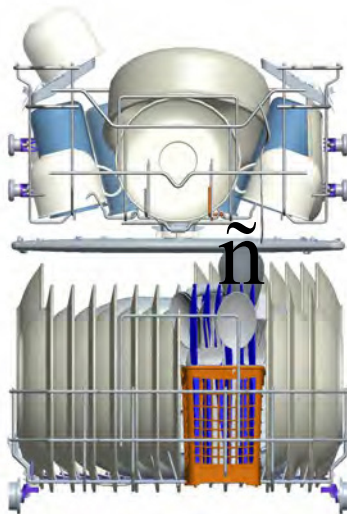

#### Important Note for Test Laboratories

For detailed information on performance tests, please contact following address: "dishwasher@standardtest.info" . In your email, please provide the model name and serial number (20 digits) which you can find on the appliance door.

## CHAPTER -6: PROGRAMME DESCRIPTIONS

### Programme items

Programme No				
Programme names and temperatures	Quickwash 14' (P1)	Quick 30' 40°C (P2)	Eco (reference) (P3)	Dual Wash 60°C (P4)
Type of food waste	Quickwash to rinse and loosen residue awaiting full load then select a programme	Coffee, milk, tea, cold meats, vegetables, not kept for long	Coffee, milk, tea, cold meats, vegetables, not kept for long	Soups, sauces, pasta, eggs, pilaf, potato and oven dishes, fried foods
Level of soil		light	medium	medium
Detergent amount B: 25 cm <sup>3</sup> / 15 cm <sup>3</sup> A: 5 cm <sup>3</sup>		A+B	A+B	A+B
	30°C Wash	40°C Wash	50°C Wash	40°C Wash
	Hot rinse	Cold Rinse	Cold Rinse	65°C Wash
	End	Hot rinse	Hot rinse	45°C Wash
		End	Dry	Hot rinse
			End	Dry
				End
Programme duration (min.)	14	30	185	106
Electricity consumption (kW hours)	0,57	0,88	0,65	1,43
Water consumption (liters)	7,7	10,9	9,0	15,4

**Warning:** Short programmes do not include a drying step. The values declared above are the values obtained under laboratory conditions according to relevant standards. These values can change depending on the conditions of product's use and environment (network tension, water pressure, water input temperature and ambient temperature).

## CHAPTER -6: PROGRAMME DESCRIPTIONS

### Programme items

Programme No				
Programme names and temperatures	Express 50' 65°C (P5)	Hygiene 60°C (P6)	Auto Delicate 30-50°C(P7)	Auto Intensive 50-70°C(P8)
Type of food waste	Soups, sauces, pasta, eggs, potato and oven dishes, fried foods	Dishes with dense dirt waiting for a long time or requiring hygienic washing	Automatically adjust the washing time with temperature and amount of water by determining the soil level of dishes	
Level of soil	medium	heavy	light	heavy
Detergent amount B: 25 cm <sup>3</sup> / 15 cm <sup>3</sup> A: 5 cm <sup>3</sup>	A+B	A+B	A+B	A+B
	65°C Wash	60°C Wash	Automatically adjust the washing time with temperature and amount of water by determining the soil level of dishes	
	Warmish Rinse	65°C Wash		
	Hot rinse	Cold Rinse		
	End	50°C Wash		
		Hot rinse		
		Dry		
		End		
Programme duration (min.)	50	154	69-87	98-171
Electricity consumption (kW hours)	1,29	1,75	0,81-0,96	1,22-1,8
Water consumption (liters)	10,7	18,5	10,6-17,7	12,3-24,6

**\*\*Only powder detergent should be used in cycle of Quickwash programme.**

**\*\*\* You can wash your dishes through washing performance A by using cycle of Express 50' min.**

# CHAPTER -7: SWITCHING ON THE MACHINE AND SELECTING A PROGRAMME

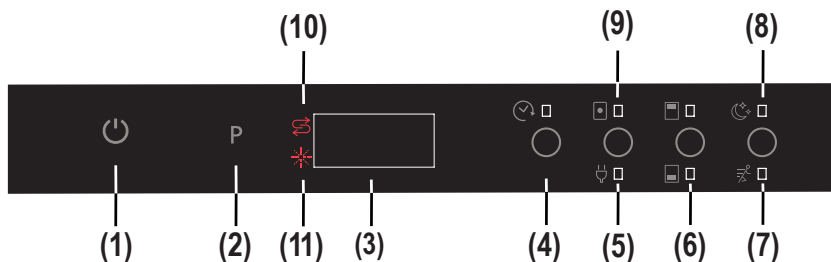

## 1.) Power On/Off Touch Button

After the Power On/Off touch is pressed, two dashes appear in the program display. Touch the "On/Off touch button" with your fingertip for 1 sec to turn the machine on or off.

## 2.) Program Touch Button

Use the Program touch button to select a suitable program for your dishes.

## 3.) Program Display

The program display indicates the length of the programs and the remaining time during the program. You can also follow-up the selected programs by this display.

## 4.) Delayed Start Touch Button

You can delay the start time of a selected program from 1 to 19 hours by pressing the delayed start touch button of the machine. When the delayed start touch button is pressed, "1h" appears on the program display. If you continue pressing the delay timer touch button, the time will increment from 1 to 19 shown on the display. The delayed start can be activated by selecting the delay time and the desired washing program with the Program touch button. It is also possible to select the program first and the delayed start afterwards, depending on the last value entered. To cancel delayed start, either select the delay timer as "0h", or hold the program touch button for 3 seconds. The display will inform you how many seconds you need to hold the button by "3-2-1..".

**Note:** If the delay touch button is pressed and held, the delay timer starts changing faster (the rate of change is proportional to the hold pressing time). When the delayed start touch button is pressed for a long period of time, the counter stops at "h:00".

## 5.)Energy Save Touch Button

The energy save option activates the door opening system at the end of the program. The auto door opening system provides the required drying performance at low rinsing temperatures and reduces energy consumption.

## 6.)½ Half Load Touch Button

Using the function ½, three sorts of washing up can be done those being lower basket, upper basket and both baskets.

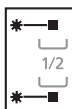

If you have a small quantity of dishes in the machine and if you have to wash them, you can activate the semi-filling function available for some of the programs. If you have dishes in both baskets, press the ½ key and select both lamps are lit.

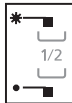

If you only have dishes in the upper basket, press the ½ key and select the upper lamp illuminated. As this will only wash items in the upper basket, make sure that there are no items in the lower basket.



If you only have dishes in the lower basket, press the ½ key and select the lower lamp illuminated. As this will only wash items in the lower basket, make sure that there are no items in the upper basket.

**Note :** If you have used an extra feature on the latest washing program, this feature will remain active on the next washing program until the machine is switched off and on again. If you do not want to use this feature on the newly selected washing program, press the selected feature button again, and check that the lamp on the button goes off.

## CHAPTER -7: SWITCHING ON THE MACHINE AND SELECTING A PROGRAMME

### 7.) Extra Fast Touch Button

This washes the dishes with more pressure, thus shortening the time of the selected program and provides more economical water usage.

**Note:** This option can only be selected at the beginning of the program.

### 8.) Extra Silent Touch Button

Washes the dishes with less pressure, thus provides more sensitive and silent washing.

**Note:** When a program that is incompatible with the Extra silent & fast option is selected, a buzzer sound is heard indicating that the selected option is not available.

### 9.) Tablet Detergent Touch Button ( 3 in 1 button )

Press the tablet detergent touch button when you use combined detergents that include salt and rinse aid.

### 10.) Salt Warning Indicator

To determine whether there is sufficient softening salt in the machine, check Salt warning light on the display. When Salt warning light turns on, add salt to the salt compartment.

### 11.) Rinse aid Warning Indicator

To determine if there is sufficient rinse aid in the machine check the rinse aid warning light on the display. When the rinse aid warning light turns on, add rinse aid to the rinse aid compartment.

### End of Program

The machine makes a buzzer sound 5 times when the program is completed. When the door is opened after the selected washing program is completed, the buzzer activation will end and a '0' character is showed on display.

**Note:** Each time the machine is switched on, the Eco program and Energy save option are set as default and previously chosen options are cancelled. When selecting programs other than Eco, the Energy save icon will go out.

## Operating your machine

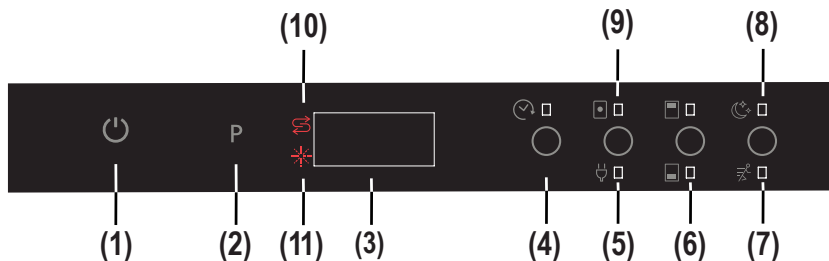

### Switching on the machine

1- Touch the power On/Off key.

When the machine is powered on, when the On/Off touch button (1) is pressed, two dashes appear in the program display.

2- When selecting a program with the program touch button (2), the program selected ( P1,P2,etc ) appears on the program display , from (P1 to P8) and the duration of the program are displayed alternately for 3 sec. for the program and then 1 sec. for the duration time.

3- "If desired, you can choose additional functions. (4-9)

4- Close door. The program starts automatically.

**Note:** If you decide not to start machine after selecting the program, press the on/off touch button (1). The machine will be ready for the new program selection when you press on/off touch button (1) again. Select the new program by pressing the program touch button (2).

### Program follow-up

- When the door is opened after the selected washing program is completed, the buzzer activation will end and a '0' character is showed on display (3).

- If the door is opened during washing cycle, the remaining time of the selected program is shown on the display (3).

- The machine makes a buzzer sound 5 times when the program is completed.

## CHAPTER -7: SWITCHING ON THE MACHINE AND SELECTING A PROGRAMME

### Changing a programme

To change the program while a wash program is going.

1- Open the door and select a new program by pressing the Program touch button (2).

2- After closing the door, the newly selected new program start from the point where the original program reached, but with the new parameters (temperature, cycles) of the new program.

**Note:** When opening the door of the machine in order to stop the washing program before it has completed, first carefully open the door slightly in order to avoid water spillage

### Changing a programme with resetting

To cancel a program currently in progress or in a standby position.

1- Open the door of the machine. The last selected program will appear on the display (3).

2- Press and hold the program touch button (2) for 3 seconds. The display (3) will count from "3 to 1" and then show "0:01" to indicate that cancelling is ready.

3- After the door is closed, the discharge process starts. The machine will empty the water in it for about 30 seconds. When the program is cancelled, the machine will make a buzzer sound 5 times.

**Note:** When the door of the machine is opened in order to stop the washing program before it has completed, first carefully open the door slightly in order to avoid water spillage.

### Operating your machine

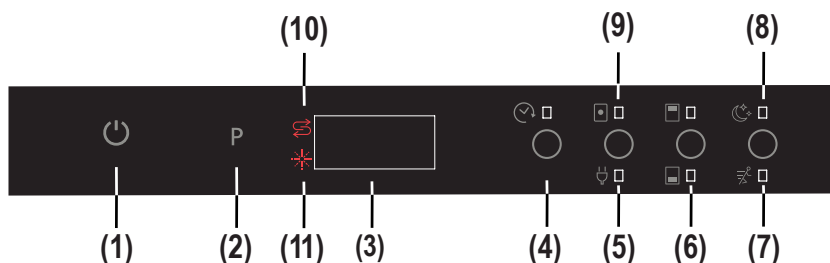

### Switching the machine off

After the program has finished, switch the machine off by using the Power On/Off touch button (1).

**Note:** To improve the drying performance, leave the door of the machine ajar in order to hasten the drying or select an energy save option before starting a program to speed up the drying performance.

**Note:** If the machine door is opened during washing or the power is cut off, the machine will restart the program when the door is closed or the power is restored.

## Program & option comparability

Option	Delayed Start	Half load (modes)	Tablet	Extra Fast	Extra Silent
Programs					
Prewash	X	X	X	-	-
Quick 30'	X	X	X	-	-
Eco	X	X	X	X	X
Dual Wash	X	X	X	X	X
Super 50'	X	X	X	-	-
Hygiene	X	X	X	-	-
Auto Delicate	X	X	X	-	-
Auto Intensive	X	X	X	-	-

"-" Function cannot be selected "X" function can be selected.  
Extra fast and Extra silent cannot be selected at the same time.

# CHAPTER -7: SWITCHING ON THE MACHINE AND SELECTING A PROGRAMME

## Compatibility between options

Options	Half load	Tablet	Start delay	Extra Fast	Extra Silent	Energy Save
Half load	-	OK	OK	OK	OK	OK
Tablet	OK	-	OK	OK	OK	OK
Start delay	OK	OK	-	OK	OK	OK
Extra Fast	OK	OK	OK	-	-	OK
Extra Silent	OK	OK	OK	-	-	OK
Energy Save	OK	OK	OK	OK	OK	-

### How to change from “ECO MODE” to “NORMAL MODE” for Inner Light option:

- 1- Open the dishwasher door and press the Power On/Off touch button. (1) (If it is in OFF position)
- 2- Press “Tablet/Energy Save” and “Delayed start”, (4) touch buttons simultaneously for 5 seconds.
- 3- “IL0” will be shown in the display (3) for 2 seconds to show the “Normal Mode” is selected for inner light option.
- 4- After “Normal Mode” is selected, the inner light will be ON as long as the machine is energized and machine door is open.

### How to change from “NORMAL MODE” to “ECO MODE” for Inner Light option:

- 1- Open the dishwasher door and press the Power On/Off touch button. (1) (if it is in OFF position)
- 2- Press “Tablet/Energy Save” and “Delayed start” (4) touch buttons simultaneously for 5 seconds.
- 3- “IL1” will be shown in the display (3) for 2 seconds to show the “Eco Mode” is selected for inner light option. Also inner light turns OFF and ON again (blinks momentarily) to show this selection is activated.
- 4- After “Eco Mode” is selected, the inner light will be ON for 4min and then turns OFF. If any user intervention occurs such as pressing touch buttons, Eco Mode cycle will start from the beginning (inner light is ON for 4min and then becomes OFF again)

**Note:** Factory setting for inner light are set to “IL1”.

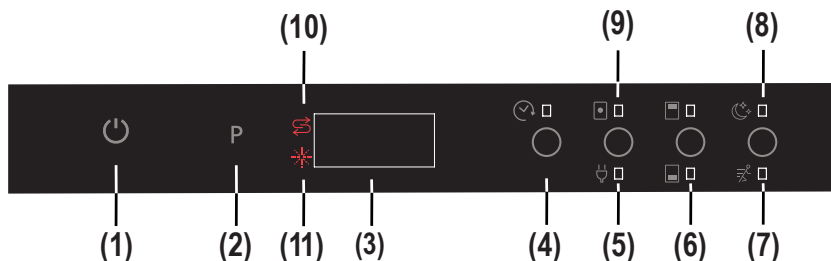

## Buzzer sound set up

The buzzer sound level can be adjusted.

- 1- Press the Power On/Off touch button (1) (if it is in OFF position).
- 2- Press the “Tablet/Energy Save” (5) and “½ Half Load Button” (6) touch buttons for 3 seconds at the same time to set the level.
- 3- While pressing “Tablet/Energy Save” (5) and “½ Half Load Button” (6) touch buttons (during 3 seconds.), display shows character of countdowning from 3 to 1.
  - If volume adjustment is done the first time, at the end of 3 seconds, “S03” is shown in the display.
  - If volume adjustment is done before, At the end of 5 seconds, the last set level is shown on the display (from “S00” to “S03”).

The user can increase or decrease the voice level with “Tablet” and “½ Half Load Button”, (6) touch buttons. The characters must be as follows;

- To increase the level of the buzzer sound
  - 1) Press “½ Half Load Button” touch button. (6)
  - 2) Display (3) changes from “S00” to “S03”
- To decrease the level of the buzzer sound
  - 1) Press “Tablet/Energy Save” touch button. (5)
  - 2) Display (3) changes from “S03” to “S00”. “S00” means that all buzzers are off.
- 4- To exit volume control mode, switch off the machine.

The last volume level was set is stored in memory.

**Note:** From sound level “3” to “1”, the loudness level is reduced by stages depending on the sound level.



## CHAPTER -8: MAINTENANCE AND CLEANING

**Cleaning the machine in regular intervals prolongs the machines service life.**

**Oil and lime may accumulate in the machines washing section. In the event of such accumulation;**

-Fill the detergent compartment without loading any dishes into the machine, run the machine at high temperature. In the event this is not sufficient, use special cleansing material.

**Cleaning the seals in the machine door,**

-Wipe the seals regularly by using a dampened cloth.

**Cleaning the machine,**

Clean the filters and spray arms at least once a week.

Unplug your machine and turn off its tap before starting the cleaning.

Wipe with a fine cleaning material and a dampened cloth.

**Filters**

If any food wastes have remained on the coarse and fine filters, remove the filters and clean them thoroughly under the water tap.

**a. Micro Filter**

**b. Coarse Filter**

**c. Metal/Plastic Filter**

To remove and clean the filter combination, turn it counter clockwise and take it out by lifting upwards. **1**

Pull and remove the metal/plastic filter. **2** Then pull the coarse filter out of the micro filter. **3** Rinse it with lots of water under the tap. Refit the metal/plastic filter. Insert the coarse filter into the micro filter in a way that the marks correspond to one another. Attach the micro filter into the metal/plastic filter and turn to the direction of the arrow. It is locked when the arrow on the micro filter can be seen from across. **4**

- Never use your dishwasher without any filter.
- The incorrect fitting of the filter will reduce the washing effectiveness.
- Clean filters are very important in terms of the proper running of the machine.

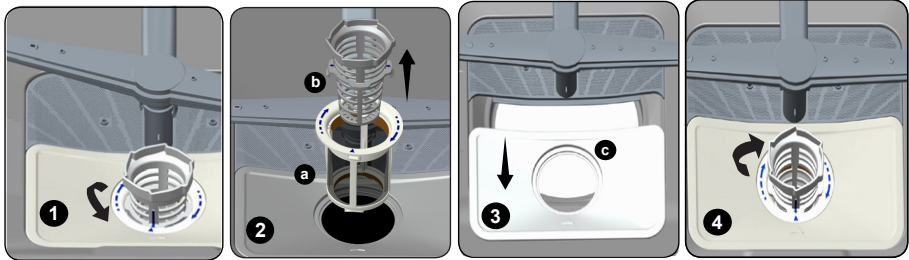

### Spray arms

Check the holes for the upper and lower spray arms. If there is any clogging, remove the spray arms and clean them under water.

You can remove the lower spray arm by pulling it upwards, while the upper spray arm nut can be removed by turning the nut to the left. Be sure that the nut is perfectly tightened when refitting the upper spray arm.

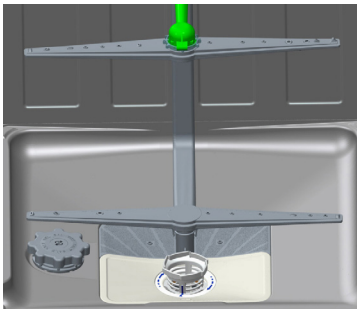

### Hose filter

Check the filter and the hose from time to time and clean them to prevent yellowing and formation of deposits after washing. To clean the filter, first turn off your tap and then remove the hose. After removing the filter from the hose, clean it under the tap. Insert the cleaned filter back into its place inside the hose. Refit the hose.

## CHAPTER -9: FAILURE CODES AND WHAT TO DO IN CASE OF FAILURE

ERROR CODE	ERROR DESCRIPTION	CONTROL
F5	Inadequate water supply	<ul style="list-style-type: none"> <li>• Make sure the water input tap is totally open and that there is no water cut.</li> <li>• Close the water input tap, separate the water input hose from the tap and clean the filter at the connection end of the hose.</li> <li>• Restart your machine, contact for service if the error resumes.</li> </ul>
F3	Error of continuous water input	<ul style="list-style-type: none"> <li>• Close the tap.</li> <li>• Contact for service.</li> </ul>
F2	The waste water in the machine cannot be discharged.	<ul style="list-style-type: none"> <li>• Water discharge hose is clogged.</li> <li>• The filters of your machine might be clogged.</li> <li>• Power off-on your machine and activate the program cancellation command.</li> <li>• If the error continues, contact for service.</li> </ul>
F8	Heater error	<ul style="list-style-type: none"> <li>• Contact service.</li> </ul>
F1	Alarm is active against water overflow	<ul style="list-style-type: none"> <li>• Power off your machine and close the tap.</li> <li>• Contact for service.</li> </ul>
FE	Faulty electronic card	<ul style="list-style-type: none"> <li>• Contact for service.</li> </ul>
F7	Overheating error (temperature in the machine is too high)	<ul style="list-style-type: none"> <li>• Contact for service.</li> </ul>
F9	Divisor position error	<ul style="list-style-type: none"> <li>• Contact for service.</li> </ul>
F6	Faulty heater sensor	<ul style="list-style-type: none"> <li>• Contact for service.</li> </ul>

**If one of the program monitor lights is on and start/Pause light is on and off,**

Your machines door is open, shut the door.

**If the programme won't start**

- Check if the plug is connected.
- Check your indoor fuses.
- Be sure that the water inlet tap is turned on.
- Be sure that you have closed the machine door.
- Be sure that you switched off the machine by pressing the Power On / Off button.
- Be sure that the water inlet filter and the machine filters are not clogged.

**If the lamps "Wash/Dry" and "End" keep flashing**

- The water overflow alarm is active
- Turn off your tap and contact the Sharp help desk.

**If the control lamps won't go out after a wash operation**

Check if the Power On/Off button is released.

**If detergent residues are left in the detergent compartment**

Detergent has been added when the detergent compartment was wet.

**If water is left inside the machine at the end of the programme**

- The water drain hose is clogged or twisted.
- The filters are clogged.
- The programme is not finished yet.

**If the machine stops during a wash operation**

- Power failure.
- Water inlet failure.
- Program can be on standby mode.

**If shaking and hitting noises are heard during a wash operation**

- Dishes placed incorrectly.
- Spray arm hitting the dishes.

**If there are partial food wastes left on the dishes**

- Dishes placed incorrectly into the machine, sprayed water did not reach related places.
- Basket overly loaded.
- Dishes leaning against one another.
- Small amount of detergent added.
- An unsuitable, weak wash programme selected.
- Spray arm clogged with food wastes.
- Filters clogged.
- Filters incorrectly fitted.
- Water drain pump clogged.

## CHAPTER -10: PRACTICAL AND USEFUL INFORMATION

### **If there are whitish stains on the dishes**

- insufficient detergent is being used
- Rinse aid dosage setting at a very low level.
- No special salt is being used despite the high degree of water hardness.
- Water softener system setting is at a very low level.
- Salt compartment cap not closed well.

### **Won't dry no need for dry**

- A programme without a dry operation has been selected.
- Rinse aid dosage set too low
- Dishes unloaded too fast.

### **If there are rust stains on the dishes**

- Stainless-steel quality of the dishes washed is insufficient.
- High rate of salt in the wash water.
- Salt compartment cap not properly closed.
- Too much salt spilt into the sides and into the machine whilst filling it with salt.
- Poor mains grounding.

**Call an authorised service if the problem still persists after the controls or in case of any malfunction not described above.**

### **PRACTICAL AND USEFUL INFORMATION**

**1-** When you won't be using your machine for an extended period

- Unplug the machine and then turn the water off.
- Leave the door slightly ajar in order to prevent the formation of unpleasant smells.
- Keep the machine interior clean.

**2-** Eliminating water droplets

- Wash the dishes with the intensive programme.
- Take all of the metal containers in the machine out.
- Do not add detergent.

**3-** If you properly place your dishes into the machine, you will be using it in the best way in terms of energy consumption, washing and drying performance.

**4-** Clean all rough waste before you place dirty dishes to the machine.

**5-** Operate the machine after it is completely full.

**6-** Use a pre-washing program only when necessary.

**7-** Observe program information and average consumption values table when selecting a program.

**8-** Since the machine will reach high temperatures, it should not be placed near a refrigerator.

**9-** If the appliance is located in a place where the risk of freezing exists, you must completely drain the water that has remained in the machine. Turn off the water tap, disconnect the water inlet hose from the tap and allow the interior water to drain.

The dishwasher contains biocidal product in the PP sump filter to prevent bacterial growth.  
Active Substance: zinc pyrithione (CAS No: 13463-41-7)

## DISPOSAL OF YOUR OLD MACHINE

This symbol on the product or package implies that the product should not be treated as domestic waste. Instead, it should be delivered to applicable waste collection places recycling electrical and electronic equipment. You will contribute to avoid potential negative results regarding environment and human health. Recycling materials will help natural resources be preserved. For more detailed information regarding recycling of this product, please contact your local authority, domestic waste disposal service or the shop where you purchased the product from.





# Service & Support

Visit Our Website  
[sharphomeappliances.com](http://sharphomeappliances.com)

**SHARP**

Be Original.

52290597 R35