



QW-GD54R443X-EU





Dishwasher

EN User Manual

Thank you for choosing this product.

This User Manual contains important information on safety and instructions intended to assist you in the operation and maintenance of your appliance.

Please take the time to read this User Manual before using your appliance and keep this book for future reference.

Icon	Type	Meaning
	WARNING	Serious injury or death risk
	RISK OF ELECTRIC SHOCK	Dangerous voltage risk
	FIRE	Fire risk
	CAUTION	Injury or property damage risk
	IMPORTANT / NOTE	Operating the system correctly

CONTENTS

1.SAFETY INSTRUCTIONS	1
1.1. General Safety Warnings	1
1.2. Installation Warnings	1
1.3. During Use.....	2
2.INSTALLATION	6
2.1. Machine Positioning	6
2.2. Water Connection	6
2.3. Water Inlet Hose.....	6
2.4. Drain Hose.....	6
2.5. Electrical Connection	7
3.TECHNICAL SPECIFICATIONS	8
3.1. General Appearance.....	8
3.2. Technical Specifications	8
4.BEFORE USING THE APPLIANCE	9
4.1. Preparing your Dishwasher for first use	9
4.2. Fill the Salt.....	9
4.3. Test Strip	10
4.4. Water Hardness Table	10
4.5. Water Softener System	10
4.6. Setting	10
4.7. Detergent Usage	10
4.8. Filling the Detergent	11
4.9. Using Combined Detergents	11
4.10. Rinse-aid Usage	11
4.11. Filling the Rinse-aid and Setting	11
5.LOADING YOUR DISHWASHER	12
5.1. Recommendations.....	12
5.2. Alternative Basket Loads	14
6.PROGRAMME TABLE	15
7.THE CONTROL PANEL	16
7.1. Changing a Programme	17
7.2. Cancelling a Programme	17
7.3. Switching the Machine Off.....	17

8.CLEANING AND MAINTENANCE	19
8.1. Cleaning the Machine and Filters	19
8.2. Spray Arms	19
9.TROUBLESHOOTING	20
10.PRACTICAL INFORMATION.....	22
11.THE PRODUCT FICHE	23

1. SAFETY INSTRUCTIONS

1.1. General Safety Warnings

- Read these instructions carefully before using your appliance and keep this manual for future reference.

 Please check the packaging of your machine before installation and the outer surface of the machine once the packaging has been removed. Do not operate the machine if it appears damaged or if the packaging has been opened.

- Packaging materials protect your machine from any damage that might occur during transportation. The packaging materials are environmentally friendly as they are recyclable. Use of recycled material reduces raw material consumption and decreases waste production.

 This appliance can be used by children aged from 8 years and above, and by persons with reduced physical, sensory or mental capabilities or lack of experience and knowledge if they have been given supervision or instruction concerning the use of the appliance in a safe way and understand hazards involved. Children should not be allowed to play with the appliance.

 Remove packaging and keep it out of reach of children.

 Keep children away from detergents and rinse aids.

 There may be some residue left in the machine after washing. Keep children away from the machine when it is open.

1.2. Installation Warnings

- Choose a suitable and safe place to install your machine.
- Only original spare parts should be used with the machine.

 Unplug the machine before installation.

 Your machine must only be installed by an authorised service agent. Installation by anyone other than an authorised agent may cause your warranty to be void.

 Check that the indoor electrical fuse system is connected in line with safety regulations.

 All electrical connections must match the values on the plate.

 Ensure the machine does not stand on the electrical supply cable.

 Never use an extension cord or a multiple socket connection.

 The plug should be accessible after the machine is installed.

- After installation, run your machine unloaded for the first time.

 The machine must not be plugged in during positioning.

 Always use the coated plug supplied with your machine.

 If the electrical cable is damaged, it should only be replaced by a qualified electrician.

1.3. During Usege

- This machine is for domestic use only; do not use

- it for other purposes. Commercial use will void the guarantee.

 Do not stand, sit or place loads on the open door of the dishwasher.

 Only use detergents and rinse aids produced specifically for dishwashers. Our company is not responsible for any damage that may occur due to misuse.

 Do not drink water from the machine.

 Due to the danger of explosion, do not place any chemical dissolving agents into the machine's washing section.



- Check the heat-resistance of plastic items before washing them in the machine.

 Only put items in the machine which are suitable for dishwashing, and take care not to overfill the baskets.

 Do not open the door while the machine is in operation, hot water may spill out. Safety devices ensure the machine stops if the door is opened.

 The machine door should not be left open. It may cause accidents.

 Place knives and other sharp objects in the cutlery basket in a blade-down position.

  For models with the automatic door-opening system, when the EnergySave option is active, the door will open at the end of a program. To prevent damage to your dishwasher, do not attempt to close the door for one minute after it has opened. For effective drying, keep the door open for 30 minutes after a programme has ended. Do not stand in front of the door after the auto-open signal sounds.

 In the case of a malfunction, repair should only

be performed by an authorised service company, otherwise the warranty will be void.

 Before repair work, the machine should be disconnected from the mains. Do not pull the cable to unplug the machine. Switch off the water tap.

 Operation at a low voltage will cause a decline in performance levels.

 For safety, disconnect the plug once a program has finished.

 To avoid an electric shock, do not unplug the machine with wet hands.

 Pull the plug to disconnect the machine from the mains, never pull on the cord.

RECYCLING

- Some machine components and packaging consist of recyclable materials.
- Plastics are marked with the international abbreviations: (>PE<, >PP<, etc.)
- The cardboard parts consist of recycled paper. They can be put into waste paper containers for recycling.
- Material unsuitable for domestic waste must be disposed of at recycling centres.
- Contact a relevant recycling centre to obtain information about disposal of different materials.

PACKAGING AND THE ENVIRONMENT

- Packaging materials protect your machine from damage that may occur during transportation. The packaging materials are environmentally friendly as they are recyclable. The use of recycled material reduces raw material consumption and therefore decreases waste production.

CE Declaration of Conformity

We declare that our products meet the applicable European Directives, Decisions and Regulations and the requirements listed in the standards referenced.

Disposal of your old machine



The symbol on the product or on its packaging indicates that this product may not be treated as household waste. Instead, it shall be handed over to the applicable collection point for the recycling of electrical and electronic equipment. By ensuring this product is disposed of correctly, you will help prevent potential negative consequences for the environment and human health, which could otherwise be caused by inappropriate waste handling of this product. For more detailed information about recycling of this product,

please contact your local city office, your household waste disposal service or the shop where the product was purchased.

2. INSTALLATION

2.1. Machine positioning

When positioning the machine, place it in an area where dishes can be easily loaded and unloaded. Do not put the machine in an area where the ambient temperature falls below 0°C.

Read all warnings located on the packaging before removing the packaging and positioning the machine.

Place the machine close to a water tap and drain. Take into consideration that the connections will not be altered once the machine is in position.

Do not hold the machine by its door or panel.

Leave an adequate distance around the machine to allow ease of movement when cleaning.

 Ensure the water inlet and outlet hoses are not squeezed or trapped and that the machine does not stand on the electrical cable while positioning.

Adjust the feet so the machine is level and balanced. The machine should be placed on flat ground otherwise it will be unstable and the door of the machine will not close properly.

2.2. Water connection

We recommend fitting a filter to your water inlet supply in order to prevent damage to your machine due to contamination (sand, rust, etc.) from indoor plumbing. This will also help prevent yellowing and deposit formation after washing.

2.3. Water inlet hose

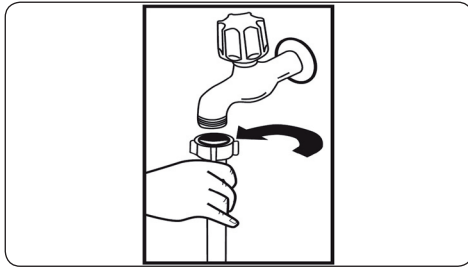

 **WARNING:** Use the new water inlet hose supplied with your machine, do not use an old machine's hose.

 **WARNING:** Run water through the

new hose before connecting.

 **WARNING:** Connect the hose directly to the water inlet tap. The pressure supplied by the tap should be a minimum of 0.03 MPa and a maximum of 1 MPa. If the pressure exceeds 1 MPa, a pressure relief valve must be fitted between the connection.

 **WARNING:** After the connections are made, turn the tap on fully and check for water leaks. Always turn off the water inlet tap after a wash program has finished.

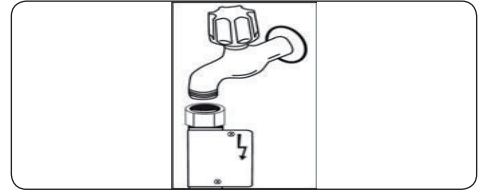

 An Aquastop water spout is available with some models. Do not damage it or allow it to become kinked or twisted.

2.4. Drain Hose

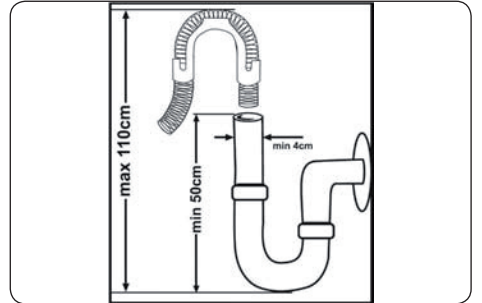

Connect the water drain hose directly to water drain hole or to the sink outlet spigot. This connection should be minimum 50 cm and maximum 110 cm from floor plane.

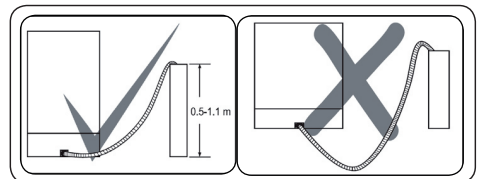

 **IMPORTANT:** Items will not wash properly if a drain hose longer than 4 m is used.





2.5. Electrical connection

2.6. Electrical connection

 **WARNING:** Your machine is set to operate at 220-240 V. If the mains voltage supply to your machine is 110 V, connect a transformer of 110/220 V and 3000 W between the electrical connection.

  **The earthed plug of the machine must be connected to an earthed outlet supplied by suitable voltage and current.**

  **In the absence of earthing installation, an authorised electrician should carry out an earthing installation. In the case of use without earthing installed, we will not be responsible for any loss of use that may occur.**

 **The indoor fuse current value should be 10-16 A.**

3. TECHNICAL SPECIFICATIONS

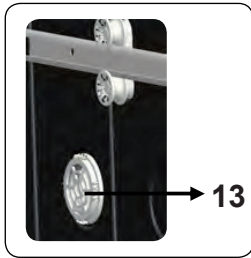
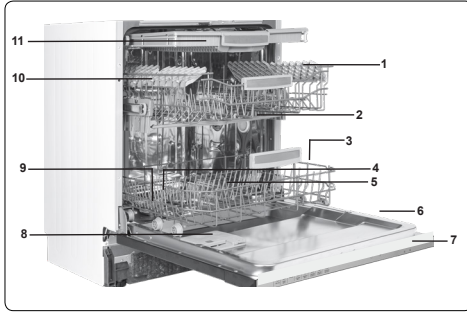

3.1. General appearance

1. Upper basket with racks
2. Upper spray arm
3. Lower basket
4. Lower spray arm
5. Filters
6. Rating plate
7. Control panel
8. Detergent and rinse-aid dispenser
9. Salt dispenser
10. Upper basket track latch
11. Upper Cutlery Basket
12. Turbo Drying Unit: This system provides better drying performance.

3.2. Technical specifications

Capacity	15 place settings
Dimensions	
Height	820-870(mm)
Width	596(mm)
Depth	550(mm)
Net weight	38 kg
Operating voltage / frequency	220-240V 50 (Hz)
Total current	10(A)
Total power	1900(W)
Water supply pressure	Maximum: 1 (Mpa) Minimum: 0.03 (Mpa)

4. BEFORE USING THE APPLIANCE

4.1. Preparing your Dishwasher for first use

- Check whether the electricity and supply water specifications match the values indicated in the installation instructions for the machine.
- Remove all packaging materials inside the machine.
- Set the water softener level.
- Fill the rinse aid compartment.

4.2. Fill the salt (IF AVAILABLE)

To fill with softener salt, open the salt compartment cap by turning it counter clockwise. **(1)** **(2)** At first use, fill the compartment with 1 kg salt and water **(3)** until it is almost overflowing. If available, using the funnel **(4)** provided will make filling easier. Replace the cap and close it. After every 20th-30th wash, add salt into your machine until it fills up (approx. 1 kg).

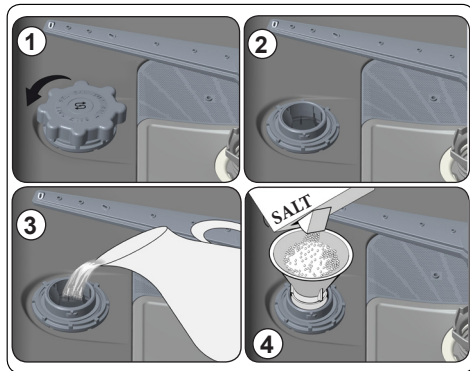

Fill the salt compartment with water the first time you fill the salt compartment only.







Use softener salt specifically produced for use in dishwashers.

When you start your dishwasher, the salt compartment is filled with water, therefore put the softener salt in prior to starting your machine.

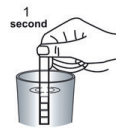
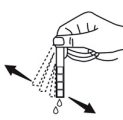
If the softener salt has overflowed and you do not start the machine immediately, run a short washing program to protect your

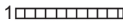
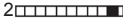
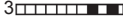
machine against corrosion.

4.3. Test Strip

Run water through tap (1min.)	Keep the strip in water (1sec)	Shake the strip.	Wait (1min.)	Set the hardness level of your machine.
				1  2  3  4  5  6 

NOTE: Level is set 3 as default. If the water is well water or has a hardness level above 90 dF, we recommend that you use filter and refinement devices.

4.4. Water Hardness Table

Level	German dH	French dF	British dE	Indicator
1	0-5	0-9	0-6	L1 is shown on display.
2	6-11	10-20	7-14	L2 is shown on display.
3	12-17	21-30	15-21	L3 is shown on display.
4	18-22	31-40	22-28	L4 is shown on display.
5	23-31	41-55	29-39	L5 is shown on display.
6	32-50	56-90	40-63	L6 is shown on display.

4.5. Water Softener System

The dishwasher is equipped with a water softener which reduces the hardness in the mains water supply. To find out the hardness level of your tap water, contact your water company or use the test strip (if available).

4.6. Setting

- Touch the programme button and hold it down.
- Turn on the machine.
- Hold down the programme button until “SL” disappears.
- The machine will display the last setting.
- Set the level by touching the programme button.
- Switch off the machine to save the setting.

4.7. Detergent usage

Only use detergents specifically designed for domestic dishwashers.

Add the recommended amount of detergent for the selected programme to ensure the best performance.

Keep your detergents in cool, dry places out of reach of children.

See the detergent manufacturer’s instructions for a further information.

4.8. Filling the detergent

Push the latch to open the dispenser and pour in the detergent.

Close the lid and press it until it locks in place. The dispenser should be refilled just before the start of each programme. If the dishes are heavily soiled, place additional detergent in the pre-wash detergent chamber.

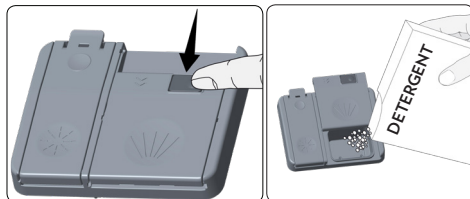

4.9. Using combined detergents

These products should be used according to the manufacturer's instructions.

Never put combined detergents into the interior section or the cutlery basket.

Combined detergents contain not only the detergent but also rinse-aid, salt replacement substances and additional components depending on the combination.

We recommend you do not use combined detergents in short programmes.

Please use powder detergents in such programmes.

If you encounter problems when using combined detergents, please contact the detergent manufacturer.

When you stop using combined detergents, make sure that water hardness and rinse aid settings are set to correct level.

4.10. Rinse-aid usage

Rinse-aid makes dishes sparkle and helps them to dry without spotting. Rinse-aid is required for stain-free utensils and clear glasses. Use only rinse-aid for domestic dishwashers.

4.11. Filling the rinse-aid and setting

To fill the rinse aid compartment, open the rinse-aid compartment cap. Fill the compartment with rinse aid until MAX level and then close the cap. Be careful not to overfill the rinse aid compartment and wipe up any spills.

In order to set rinse aid level, follow below steps.

- Touch the programme button and hold it down.
- Turn on the machine.
- Hold down the programme button until "rA" disappears. Rinse aid set follows water hardness set.
- The machine will display the last setting.
- Set the level by touching the programme button.
- Switch off the machine to save the setting.

The factory setting is "4".

If the dishes are not drying properly or are spotted, increase the level. If blue stains form on your dishes, decrease level.

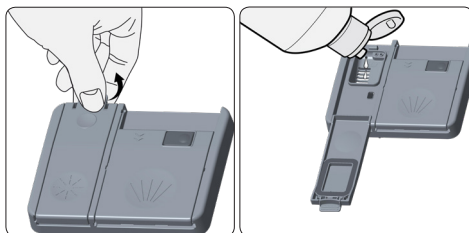

Level	Brightener Dose	Indicator
1	Rinse-aid not dispensed	r1 is shown on the display
2	1 dose is dispensed	r2 is shown on the display
3	2 doses are dispensed	r3 is shown on the display.
4	3 doses are dispensed	r4 is shown on the display.
5	4 doses are dispensed	r5 is shown on the display.

5. LOADING YOUR DISHWASHER

For best results, follow these loading guidelines.

We recommend that you place large items (pots, pans, lids, plates and bowls) which are heavily soiled in the lower basket.

The upper basket is designed for delicate and lighter dishware such as glasses, coffee and tea cups and saucers. Position the dishes so that they will not get moved by the spray of water.

Cutlery should be placed in the cutlery basket. Items should be loaded individually into the appropriate slots with their handles downwards. Long utensils should be placed horizontally on the baskets.



WARNING: Take care not to obstruct the rotation of spray arms.

5.1. Recommendations

Remove any coarse residue on dishes before placing the dishes in the machine. Start the machine with full load.



Do not overload the drawers or place dishes in the wrong basket.



WARNING: Always place sharp utensils with the sharp point down and open utensils with their openings down.

Upper Basket

The upper basket includes a mechanism which enables the height of the basket to be adjusted up (1) or down (2) without having to remove the basket. Hold the basket on both sides and pull it up or push it down, ensuring both sides of the upper basket are in the same position.

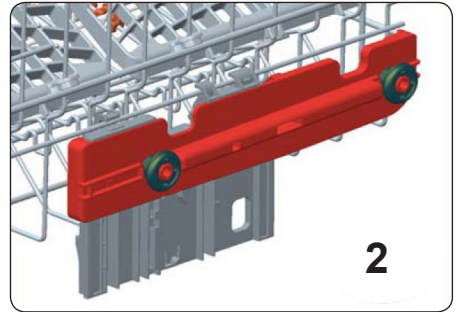
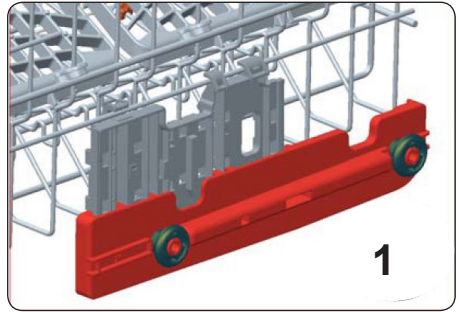
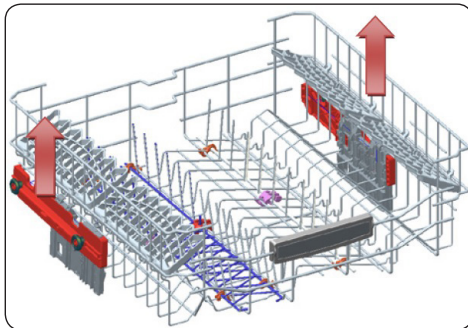

SOFT TOUCH Top basket

Height Adjustable Rack

These racks are designed to increase the capacity of the top basket. You can place your glasses and cups on the racks. You can adjust the height of these racks.

Thanks to this feature, you can place different sizes of glasses under these racks.

Thanks to height adjustment plastics mounted on the basket, you can use your racks in 2 different heights. In addition, you can place long forks, knives and spoons on these racks laterally, so that they do not block the revolution of propeller.

The soft touch feature on the racks serves to place the fine stemmed glass.

The wineglass is placed in the area shown at the picture.

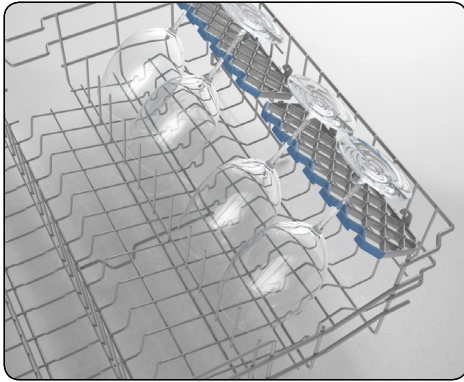

Foldable racks

Foldable racks on the upper basket are designed in order to let you place big items easier such as pots, pans, etc. If requested, each part can be folded separately, or all of them can be folded and larger spaces can be obtained. You can use foldable racks by raising them upwards, or by folding down.

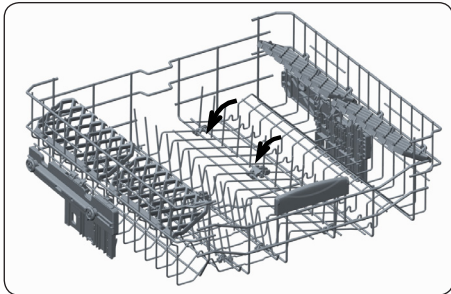

Four Folding Racks (15 pc)

The folding racks allow easier placement of larger items, such as pots and pans. Each section can be folded separately. The racks can be raised up, or folded down, as shown in the images.

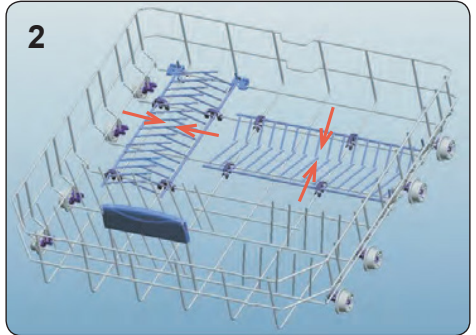
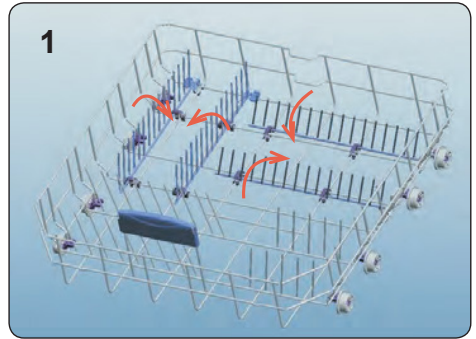

Direct wash function

This function is used to wash glasses, bottles etc. by directing the water upwards while the apparatus on the upper basket (shown in the figure) is in vertical position. While the apparatus is in horizontal position, water is directed downwards, contributing to washing the lower basket.

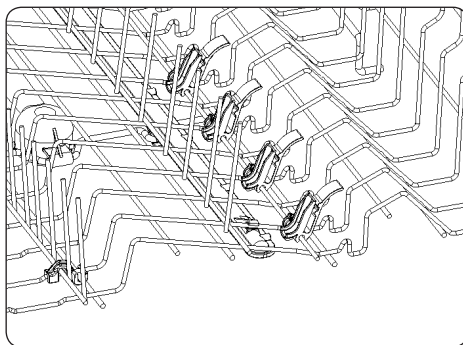
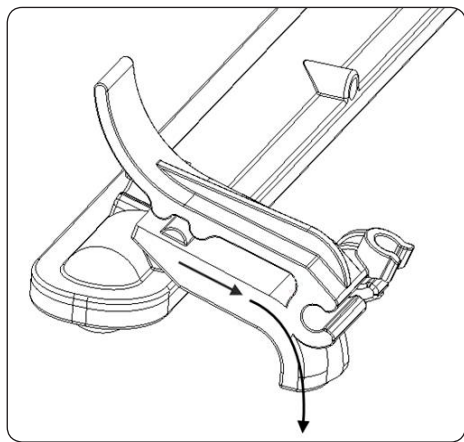
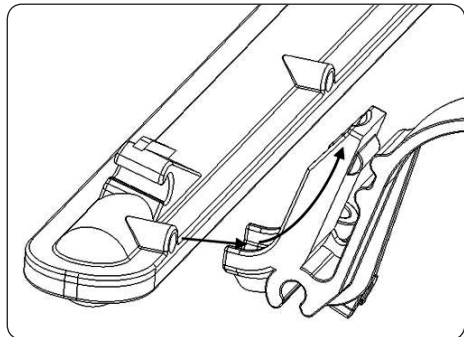

Extra lower/upper basket button) (4)

Using the Extra lower/upper basket function, three sorts of washing up can be done those being lower basket, upper basket and both baskets.

If you have only a few of dishes in your machine and if you have to wash them, you can also activate the semi-filling function for some programs. If you have dishes in both baskets, press the key and select the position in which both lamps are highlighted.

If you have dishes in the upper basket only, press Extra lower/upper basket key and select the icon where the figure above is lit. Thus, your machine will perform washing in the upper basket, and a detailed washing cycle will be carried out by the extra water jet in the upper basket.

If you have dishes in the lower basket only, press Extra lower/upper basket key and select the icon where the figure below is lit. Thus, your machine will perform washing in the lower basket, and a 360° washing cycle will be carried out by the two extra water jets on the base. Make sure that there are no dishes in the upper basket while using this feature.

Upper Cutlery Basket

The upper cutlery basket is designed for the placement of large and small cutlery and utensils.

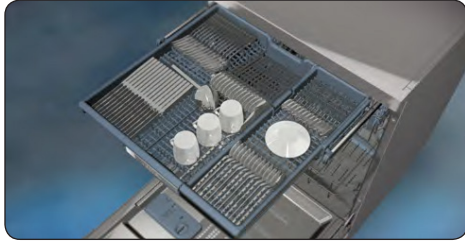

The basket is easily removed from the dishwasher, therefore allows ease of use when removing your items, along with the basket, after washing.

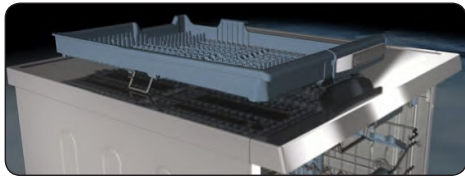

The upper cutlery basket is composed of two pieces that can be separately removed. Remove the left or right section of the cutlery basket in order to obtain more space for items in the upper basket.



WARNING: Knives and other sharp objects must be placed horizontally in the cutlery basket.

5.2. Alternative Basket Loads

Lower Basket

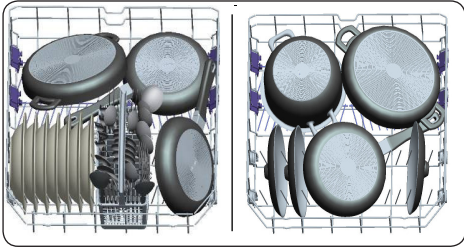

Top basket

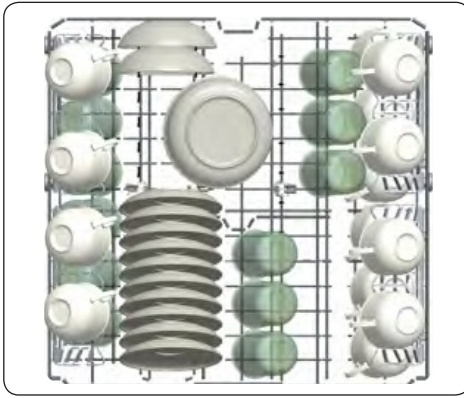

Incorrect loads

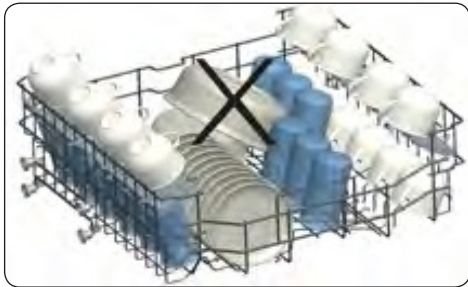
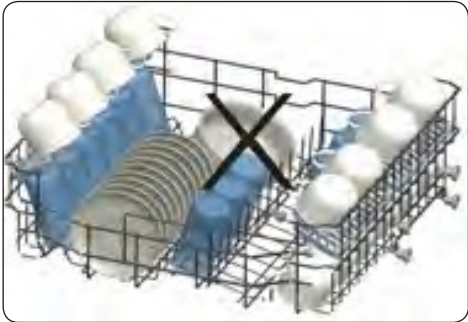
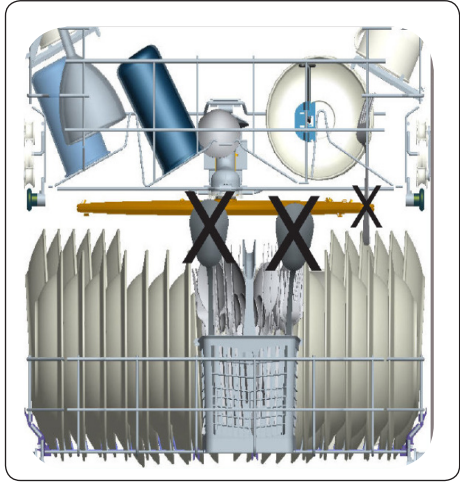
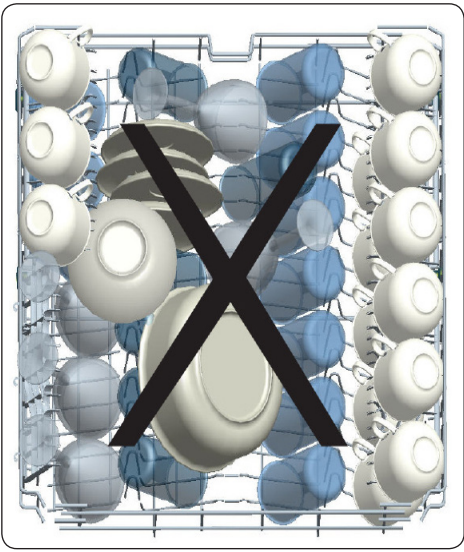

6. PROGRAMME TABLE

Programme	Duration (min)	Description
QuickWash 14'	14	Fastest programme for lightly soiled and recently used dishes. Suitable for 4 place settings.
Quick 30'	30	For lightly soiled dishes and a quick wash.
Eco (Reference)	195	Standard programme for normally soiled, daily-used dishes.
Dual Pro Wash	112	For both lightly soiled, delicate glassware and heavily soiled crockery at the same time.
Express 50'	50	For normally soiled, daily-used dishes with a faster programme.
Hygiene	154	High-temperature, disinfecting programme for heavily soiled dishes.
Auto Delicate	77-91	Auto programme for normally soiled, delicate dishes.
Auto Intensive	124-179	Auto programme for heavily soiled dishes.



NOTE: THE PROGRAMME DURATION MAY CHANGE ACCORDING TO THE AMOUNT OF DISHES, THE WATER TEMPERATURE, THE AMBIENT TEMPERATURE AND SELECTED ADDITIONAL FUNCTIONS.

- Only use powder detergent for short programmes.
- Short programmes do not include drying.
- To assist drying, we recommend slightly opening the door after a cycle is complete.

7. THE CONTROL PANEL

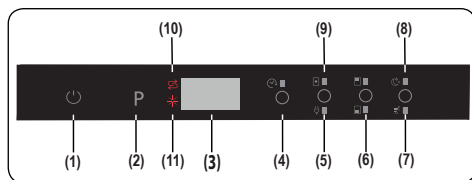

Press the On/Off touch button (1) for 1 second to switch the machine on. Two dashes will appear on the Programme Display.

Select the programme most suitable for your dishes using the Programme touch button (2). The selected programme, P1, P2, and so on, will appear on the Programme Display (3), from P1 to P6. The selected programme will display for 3 seconds then its duration will show for 1 second, alternately.

Additional functions can also be selected.

NOTE: Press the Energy Save touch button (5) to activate the automatic door-opening system at the end of a programme. This reduces energy consumption by operating at low rinsing temperatures and improves the drying performance.

NOTE: Each time the machine is switched off and on, the Eco and Energy Save programmes will be set as default. Options chosen before will be cancelled. If another programme is selected, the Energy Save icon will switch off.

NOTE: Press the Extra Fast touch button (7) to reduce the programme duration. The washing water temperature and pressure will increase to ensure an improved washing quality in a shorter duration. This option can only be selected at the beginning of a programme.

NOTE: Press the Extra Silent touch button (8) to decrease the water pressure, therefore providing a more sensitive and silent wash. This option can only be selected at the beginning of a programme.

NOTE: If a programme is selected that is incompatible with the Extra Silent or Extra Fast button, a buzzer will sound.

NOTE: Using the Extra lower/upper basket function (6), three sorts of washing up can be done those being lower basket, upper basket and both baskets. If you have only a few of dishes in your machine and if you have to wash them, you can also activate the semi-filling function for some programs. If you have dishes in both baskets, press the touch button and select the position in which both lamps are highlighted.

If you have dishes in the upper basket only, press Extra lower/upper basket touch button and select the lamp where the figure above is lit. Thus, your machine will perform washing in the upper basket, and a detailed washing cycle will be carried out by the extra water spray in the upper basket.

If you have dishes in the lower basket only, press Extra lower/upper basket key and select the lamp where the figure below is lit. Thus, your machine will perform washing in the lower basket, and a 360° washing cycle will be carried out by the two extra sprays on the base. Make sure that there are no dishes in the upper basket while using this feature.

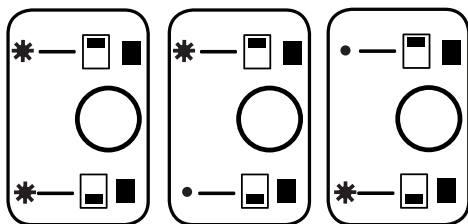

NOTE: Press the Tablet Detergent button (9) when a combined detergent is used that includes salt and rinse aid.

NOTE: If an extra feature has been used on the most recent wash programme, this feature will remain active on the next selected programme. To cancel this feature on the newly selected wash programme, press the feature button until the light on the button switches off.

 **NOTE:** For dishwashers with an InfoLED function, the InfoLED light will illuminate when in operation. When the programme is complete, the InfoLED will switch off.

 **NOTE:** When there is insufficient softening salt, the Salt Lack Warning Indicator (10) will illuminate to indicate the salt chamber needs filling.

 **NOTE:** When there is insufficient rinse aid, the Rinse Aid Lack Warning Indicator (11) will illuminate to indicate the rinse aid chamber needs filling.

Delaying the Programme

Press the Delay Start touch button (4) to delay the start time of a programme for 1 hour up to 19 hours. Pressing once will delay the start time for 1 hour, and continuing to press the button will increase the delay duration. The programme can be selected first and the delay duration after, or vice versa. To cancel the delayed start, either change the delay timer to "0h" or hold the Programme touch button for 3 seconds. The display will count down how many seconds to hold the button for in order to cancel the delay, "3-2-1".

 **NOTE:** Press and hold the Delay touch button to change the delayed start time faster. The rate of change in time is proportional to the how long the button is pressed and held for. When the Delay Start touch button is pressed for a long period of time, the counter will stop at "h:00".

7.1. Changing a Programme

Follow the steps below to change a programme while in operation.

1. Open the door and press the Programme touch button (2) to select a new programme. If the door is opened during operation, the time remaining of the selected programme will show on the display (3).
2. After closing the door, the newly selected programme will resume the course of the old programme.

 **NOTE:** Open the door slightly at first

to stop a wash programme before it is complete in order to avoid water spillage.

7.2. Cancelling a Programme

Follow the step below to cancel a programme while in operation or while in standby mode.

3. After the door is closed, the water discharge process will start and continue for 30 seconds. When a programme is cancelled, a buzzer will sound 5 times.

 **NOTE:** When the door is opened after the selected wash programme is complete, a buzzer will sound and '0' will show on the display (3).

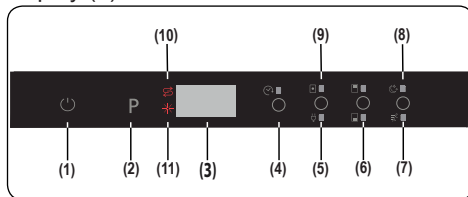

7.3. Switching the Machine Off

When the selected wash programme is complete, a buzzer will sound 5 times. You can then switch your machine off using the Power On/Off touch button (1).

 **NOTE:** Do not open the door before a programme is complete.

 **NOTE:** Leave the door of your machine slightly open at the end of a wash programme to speed up drying.

 **NOTE:** If the door of the machine is opened or the power is cut during operation, the programme will restart when the door is closed or the power returns.

Programme and Option Compatibility

OPTIONS PROGRAMS	Delayed Start	Half load (3 modes)	Tablet	Extra Fast	Extra Silent
Mini 14'	✓	✓	✓	-	-
Quick 30'	✓	✓	✓	-	-
Eco	✓	✓	✓	-	-
Dual Pro Wash	✓	✓	✓	✓	✓
Express	✓	✓	✓	-	-
Hygiene	✓	✓	✓	-	-
Auto Delicate	✓	✓	✓	-	-
Auto Intensive	✓	✓	✓	-	-

"-" Function cannot be selected

"✓" function can be selected.

Extra Fast and Extra Silent cannot be selected at the same time.

Buzzer Sound Set-up

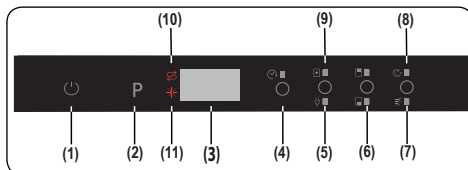

1. Press the Power On/Off touch button (1) if your machine is switched off.
2. Simultaneously press the Tablet/Energy Save (5, 9) and Extra Fast/

Silent (7, 8) touch buttons for 3 seconds to set the volume level.

3. The display will show a countdown from 3 to 1 second while the button is being pressed and held.

When setting the volume level for the first time, "S03" will show on the display at the end of the 3 seconds.

If the volume level has been set before, at the end of the 3 seconds the last set level will show on the display, from "S00" to "S03".

The Extra Fast/Silent touch button increases the volume level from "S00" to "S03". The Tablet/Energy save button decreases the volume level from "S03" to "S00". "S00" indicates no sound.

4. When the machine is switched off, the last selected volume level is stored.

8. CLEANING AND MAINTENANCE

Cleaning your Dishwasher is important to maintain the machine's service life.

Oil and lime may build up in your Dishwasher over time. If this occurs:

- Fill the detergent compartment but do not load any dishes. Select a programme which runs at high temperature and run the Dishwasher empty. If this does not clean your Dishwasher sufficiently, use a cleaning agent designed for use with dishwashers.
- **Wipe the door seals regularly with a damp cloth to remove any accumulated residue.**

8.1. Cleaning machine and filters

Clean the filters and spray arms at least once a week. If any food waste remains on the coarse and fine filters, remove them and clean them thoroughly with water.

- a) Micro Filter b) Coarse Filter
c) Metal Filter

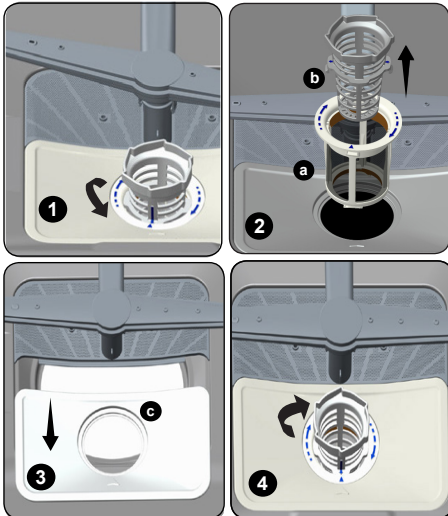

To remove and clean the filter combination, turn it counter clockwise and remove it by lifting it upwards (1). Pull the coarse filter out of the micro filter (2). Then pull and remove the metal filter (3). Rinse the filter with lots of water until it is free of residue. Reassemble

the filters. Replace the filter insert, and rotate it clockwise (4).

- Never use your Dishwasher without a filter.
- Incorrect fitting of the filter will reduce the washing effectiveness.
- Clean filters are necessary for proper running of the machine.

8.2. Spray arms

Make sure that the spray holes are not clogged and that no food waste is stuck to the spray arms. If there is any clogging, remove the spray arms and clean them under water. To remove the upper spray arm undo the nut holding it in position by turning it clockwise and pulling it downwards. Make sure that the nut is properly tightened when refitting the upper spray arm.

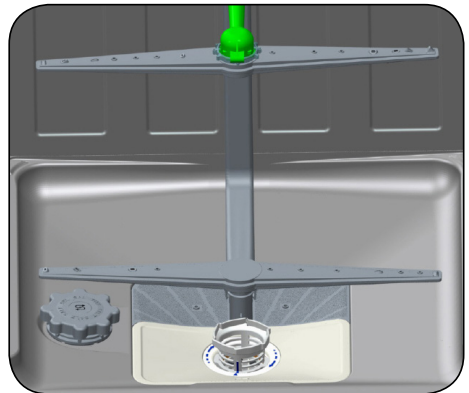

9. TROUBLESHOOTING

FAULT	POSSIBLE CAUSE	TROUBLESHOOTING
The programme does not start.	Your Dishwasher is not plugged in.	Plug your Dishwasher in.
	Your Dishwasher is not switched on.	Switch your Dishwasher on by pressing the On/Off button.
	Fuse blown.	Check your indoor fuses.
	Water inlet tap is closed.	Turn on the water inlet tap.
	Your Dishwasher door is open.	Close the Dishwasher door.
	Water inlet hose and machine filters are clogged.	Check the water inlet hose and machine filters and make sure they are not clogged.
Water remains inside the machine.	Water drain hose is clogged or twisted.	Check the drain hose, then either clean or untwist it.
	The filters are clogged.	Clean the filters.
	The programme is not finished yet.	Wait until the programme is finished.
Machine stops during washing.	Power failure.	Check mains power.
	Water inlet failure.	Check water tap.
Shaking and hitting noises are heard during a wash operation.	The spray arm is hitting the dishes in the lower basket.	Move or remove items blocking the spray arm.
Partial food wastes remain on the dishes.	Dishes placed incorrectly, sprayed water not reaching affected dishes.	Do not overload baskets.
	Dishes leaning each another.	Place dishes as instructed in the section on loading your dishwasher.
	Not enough detergent used.	Use the correct amount of detergent, as instructed in the programme table.
	Wrong wash programme selected.	Use the information in the programme table to select the most appropriate programme.
	Spray arms clogged with food waste.	Clean the holes in the spray arms with thin objects.
	Filters or water drain pump clogged or filter misplaced.	Check the drain hose and filters are correctly fitted.

FAULT	POSSIBLE CAUSE	TROUBLESHOOTING
Whitish stains remains on dishes.	Not enough detergent used.	Use the correct amount of detergent, as instructed in the programme table.
	Rinse aid dosage and/or water softener setting set too low.	Increase rinse aid and/or water softener level.
	High water hardness level.	Increase water softener level and add salt.
	Salt compartment cap not closed properly.	Check that the salt compartment cap is closed properly.
Dishes do not dry.	Drying option is not selected.	Select a programme with a drying option.
	Rinse aid dosage set too low.	Increase rinse aid dosage setting.
Rust stains form on the dishes.	Stainless-steel quality of the dishes is insufficient.	Use only dishwasher-proof sets.
	High level of salt in wash water.	Adjust the water hardness level using water hardness table.
	Salt compartment cap not closed properly.	Check that the salt compartment cap is closed properly.
	Too much salt spilled in the Dishwasher while filling it with salt.	Use funnel while filling salt to the compartment to avoid spillage.
	A poor mains grounding.	Consult a qualified electrician immediately.
Detergent remains in the detergent compartment.	Detergent was added when the detergent compartment was wet.	Make sure detergent compartment is dry before use.

AUTOMATIC FAULT WARNINGS AND WHAT TO DO

TROUBLE CODE	POSSIBLE FAULT	WHAT TO DO
F5	Insufficient water	Make sure the water inlet tap is open and water is flowing
		Separate the inlet hose from the tap and clean the filter of the hose.
		Contact for service if the error continues.
F3	Continuous water input	Close the tap and contact for service.
F2	Inability to discharge water	Water discharge hose and filters may be clogged.
		Cancel the program.
		If the error continues, contact for service.
F8	Heater error	Contact for service.
F1	Overflow	Unplug the machine and close the tap.
		Contact for service.
FE	Faulty electronic card	Contact for service.
F7	Overheating	Contact for service.
F9	Divisor position error	Contact for service.
F6	Faulty heater sensor	Contact for service.

10. PRACTICAL INFORMATION

- When the machine isn't in operation:
 - Disconnect the plug and close the tap.
 - Leave the door slightly open to prevent odour formation.
- Select the dry option to remove water droplets.
- Place dishes in the machine properly to achieve the best energy consumption, washing and drying performance. Please see the programme and consumption table for more information.
- Rinse dirty dishes before placing them in the dishwasher.
- Only use the Prewash programme when necessary.
- Do not place the machine near a refrigerator because it will reach high temperatures.
- If the machine is located in an area that is at risk of freezing, close the tap, disconnect the inlet hose from the tap and drain the water inside the hose and the machine completely.



Service & Support

Visit Our Website
sharphomeappliances.com

SHARP

Be Original.

52260606 R35