



# CI Z9F& 8&&&3Z67





Dishwasher

EN User Manual

**Thank you for choosing this product.**

This User Manual contains important information on safety and instructions intended to assist you in the operation and maintenance of your appliance.

Please take the time to read this User Manual before using your appliance and keep this book for future reference.

Icon	Type	Meaning
	<b>WARNING</b>	Serious injury or death risk
	<b>RISK OF ELECTRIC SHOCK</b>	Dangerous voltage risk
	<b>FIRE</b>	Fire risk
	<b>CAUTION</b>	Injury or property damage risk
	<b>IMPORTANT / NOTE</b>	Operating the system correctly

# CONTENTS

<b>1.SAFETY INSTRUCTIONS</b> .....	<b>1</b>
1.1. General Safety Warnings .....	1
1.2. Installation Warnings .....	1
1.3. During Use.....	2
<b>2.INSTALLATION</b> .....	<b>6</b>
2.1. Machine Positioning .....	6
2.2. Water Connection .....	6
2.3. Water Inlet Hose.....	6
2.4. Drain Hose.....	6
2.5. Electrical Connection .....	7
2.6. Fitting the Machine Undercounter .....	7
<b>3.TECHNICAL SPECIFICATIONS</b> .....	<b>8</b>
3.1. General Appearance.....	8
3.2. Technical Specifications .....	8
<b>4.BEFORE USING THE APPLIANCE</b> .....	<b>9</b>
4.1. Preparing your Dishwasher for first use .....	9
4.2. Fill the Salt.....	9
4.3. Test Strip .....	10
4.4. Water Hardness Table .....	10
4.5. Water Softener System .....	10
4.6. Setting .....	10
4.7. Detergent Usage .....	10
4.8. Filling the Detergent .....	11
4.9. Using Combined Detergents .....	11
4.10. Rinse-aid Usage.....	11
4.11. Filling the Rinse-aid and Setting.....	11
<b>5.LOADING YOUR DISHWASHER</b> .....	<b>1&amp;</b>
5.1. Recommendations.....	1G
5.2. Alternative Basket Loads .....	1Í
<b>6.PROGRAMME TABLE</b> .....	<b>1*</b>
<b>7.THE CONTROL PANEL</b> .....	<b>1+</b>
7.1. Adding Functions to a Programme .....	1J
7.2. Cancelling a Programme.....	œ

<b>8.CLEANING AND MAINTENANCE .....</b>	<b>2'</b>
8.1. Cleaning the Machine and Filters .....	2H
8.2. Spray Arms .....	2H
<b>9.TROUBLESHOOTING .....</b>	<b>2(</b>
<b>10.PRACTICAL INFORMATION.....</b>	<b>2*</b>
<b>11.THE PRODUCT FICHE .....</b>	<b>2+</b>

# 1. SAFETY INSTRUCTIONS

## 1.1. General Safety Warnings

- Read these instructions carefully before using your appliance and keep this manual for future reference.

 Please check the packaging of your machine before installation and the outer surface of the machine once the packaging has been removed. Do not operate the machine if it appears damaged or if the packaging has been opened.

- Packaging materials protect your machine from any damage that might occur during transportation. The packaging materials are environmentally friendly as they are recyclable. Use of recycled material reduces raw material consumption and decreases waste production.

 This appliance can be used by children aged from 8 years and above, and by persons with reduced physical, sensory or mental capabilities or lack of experience and knowledge if they have been given supervision or instruction concerning the use of the appliance in a safe way and understand hazards involved. Children should not be allowed to play with the appliance.

 Remove packaging and keep it out of reach of children.

 Keep children away from detergents and rinse aids.

 There may be some residue left in the machine after washing. Keep children away from the machine when it is open.

## 1.2. Installation Warnings

- Choose a suitable and safe place to install your machine.
- Only original spare parts should be used with the machine.

 Unplug the machine before installation.

 Your machine must only be installed by an authorised service agent. Installation by anyone other than an authorised agent may cause your warranty to be void.

 Check that the indoor electrical fuse system is connected in line with safety regulations.

 All electrical connections must match the values on the plate.

 Ensure the machine does not stand on the electrical supply cable.

 Never use an extension cord or a multiple socket connection.

 The plug should be accessible after the machine is installed.

- After installation, run your machine unloaded for the first time.

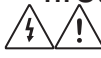
 The machine must not be plugged in during positioning.

 Always use the coated plug supplied with your machine.

 If the electrical cable is damaged, it should only be replaced by a qualified electrician.

## 1.3. During Usege

- This machine is for domestic use only; do not use

- it for other purposes. Commercial use will void the guarantee.

 Do not stand, sit or place loads on the open door of the dishwasher.

 Only use detergents and rinse aids produced specifically for dishwashers. Our company is not responsible for any damage that may occur due to misuse.

 Do not drink water from the machine.

 Due to the danger of explosion, do not place any chemical dissolving agents into the machine's washing section.

- Check the heat-resistance of plastic items before washing them in the machine.

 Only put items in the machine which are suitable for dishwashing, and take care not to overfill the baskets.

 Do not open the door while the machine is in operation, hot water may spill out. Safety devices ensure the machine stops if the door is opened.

 The machine door should not be left open. It may cause accidents.

 Place knives and other sharp objects in the cutlery basket in a blade-down position.

 For models with the automatic door-opening system, when the EnergySave option is active, the door will open at the end of a program. To prevent damage to your dishwasher, do not attempt to close the door for one minute after it has opened. For effective drying, keep the door open for 30 minutes after a programme has ended. Do not stand in front of the door after the auto-open signal sounds.

 In the case of a malfunction, repair should only

be performed by an authorised service company, otherwise the warranty will be void.

 Before repair work, the machine should be disconnected from the mains. Do not pull the cable to unplug the machine. Switch off the water tap.

 Operation at a low voltage will cause a decline in performance levels.

 For safety, disconnect the plug once a program has finished.

 To avoid an electric shock, do not unplug the machine with wet hands.

 Pull the plug to disconnect the machine from the mains, never pull on the cord.

#### **RECYCLING**

- Some machine components and packaging consist of recyclable materials.
- Plastics are marked with the international abbreviations: (>PE<, >PP<, etc. )
- The cardboard parts consist of recycled paper. They can be put into waste paper containers for recycling.
- Material unsuitable for domestic waste must be disposed of at recycling centres.
- Contact a relevant recycling centre to obtain information about disposal of different materials.

#### **PACKAGING AND THE ENVIRONMENT**

- Packaging materials protect your machine from damage that may occur during transportation. The packaging materials are environmentally friendly as they are recyclable. The use of recycled material reduces raw material consumption and therefore decreases waste production.



## CE Declaration of Conformity

We declare that our products meet the applicable European Directives, Decisions and Regulations and the requirements listed in the standards referenced.

## Disposal of your old machine



The symbol on the product or on its packaging indicates that this product may not be treated as household waste. Instead, it shall be handed over to the applicable collection point for the recycling of electrical and electronic equipment. By ensuring this product is disposed of correctly, you will help prevent potential negative consequences for the environment and human health, which could otherwise be caused by inappropriate waste handling of this product. For more detailed information about recycling of this product,

please contact your local city office, your household waste disposal service or the shop where the product was purchased.

## 2. INSTALLATION

### 2.1. Machine positioning

When positioning the machine, place it in an area where dishes can be easily loaded and unloaded. Do not put the machine in an area where the ambient temperature falls below 0°C.

Read all warnings located on the packaging before removing the packaging and positioning the machine.

Place the machine close to a water tap and drain. Take into consideration that the connections will not be altered once the machine is in position.

Do not hold the machine by its door or panel.

Leave an adequate distance around the machine to allow ease of movement when cleaning.

 Ensure the water inlet and outlet hoses are not squeezed or trapped and that the machine does not stand on the electrical cable while positioning.

Adjust the feet so the machine is level and balanced. The machine should be placed on flat ground otherwise it will be unstable and the door of the machine will not close properly.

### 2.2. Water connection

We recommend fitting a filter to your water inlet supply in order to prevent damage to your machine due to contamination (sand, rust, etc.) from indoor plumbing. This will also help prevent yellowing and deposit formation after washing.

### 2.3. Water inlet hose



 **WARNING:** Use the new water inlet hose supplied with your machine, do not use an old machine's hose.

 **WARNING:** Run water through the

new hose before connecting.

 **WARNING:** Connect the hose directly to the water inlet tap. The pressure supplied by the tap should be a minimum of 0.03 MPa and a maximum of 1 MPa. If the pressure exceeds 1 MPa, a pressure relief valve must be fitted between the connection.

 **WARNING:** After the connections are made, turn the tap on fully and check for water leaks. Always turn off the water inlet tap after a wash program has finished.

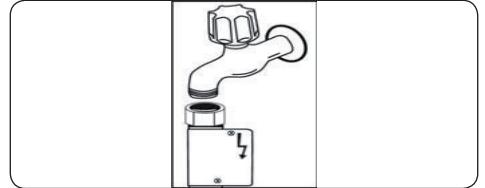

 An Aquastop water spout is available with some models. Do not damage it or allow it to become kinked or twisted.

### 2.4. Drain Hose

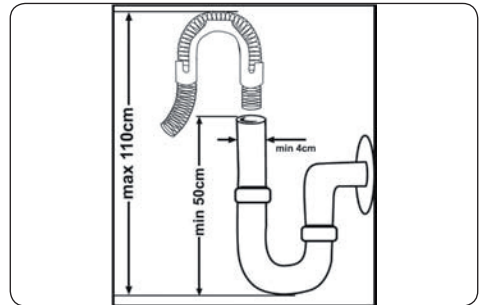

Connect water drain hose directly to water dra-in hole or to the sink outlet spigot. This connection should be minimum 50 cm and maximum 110 cm from floor plane.

 **IMPORTANT:** Items will not wash properly if a drain hose longer than 4 m is used.

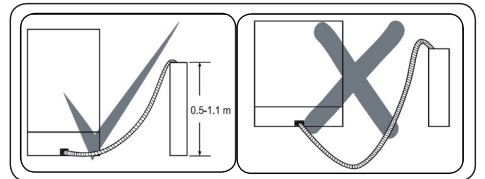

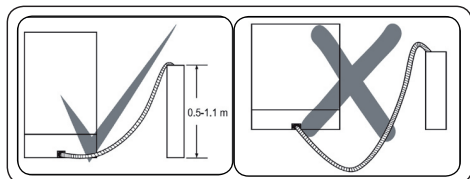

## 2.5. Electrical connection

**! WARNING:** Your machine is set to operate at 220-240 V. If the mains voltage supply to your machine is 110 V, connect a transformer of 110/220 V and 3000 W between the electrical connection.

**! !** The earthed plug of the machine must be connected to an earthed outlet supplied by suitable voltage and current.

**! !** In the absence of earthing installation, an authorised electrician should carry out an earthing installation. In the case of use without earthing installed, we will not be responsible for any loss of use that may occur.

**! The indoor fuse current value should be 10-16 A.**

## 2.6. Fitting the machine undercounter

If you wish to fit your machine undercounter, there must be sufficient space to do so and the wiring-plumbing must be suitable to do so (1). If the space under the countertop is suitable for fitting your machine, remove the worktop as shown in the illustration (2).

**! WARNING:** The countertop, of which the machine will be placed under, must be stable in order to prevent imbalance.

The top panel of the dishwasher must be removed to fit the machine under the countertop.

To remove the top panel, remove the screws that hold it on, located at the rear of the machine. Then, push the panel 1 cm from the front towards the rear and lift it. Adjust the machine feet according to the slope of the floor (3).

Fit your machine by pushing it under the counter taking care not to crush or bend the hoses (4).

**! WARNING:** After removing the top panel of your dishwasher, the machine should be placed in a space of the dimensions shown in the figure below.

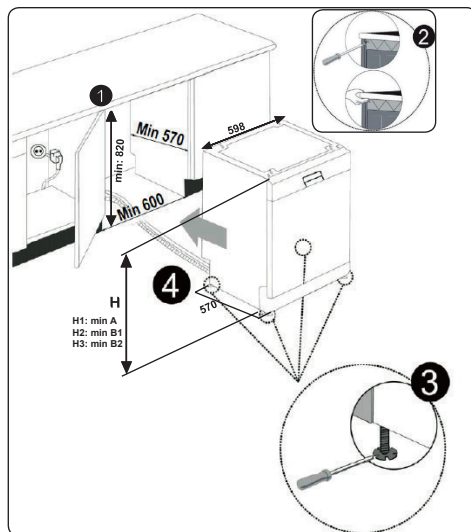

	A	B	
	All Products	B <sub>1</sub>	B <sub>2</sub>
Product's Height (±2 mm)	820 mm	830 mm	835 mm

**A:** If there is no felt on the top of the product; you should take into account this product's height.

**B1:** If there is felt on the top of the product with 2nd basket; you should take into account this product's height.

**B2:** If there is felt on the top of the product with 3rd basket; you should take into account this product's height.

### 3. TECHNICAL SPECIFICATIONS

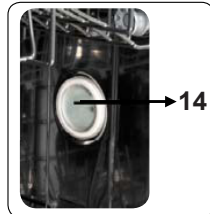
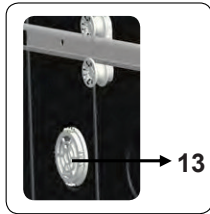
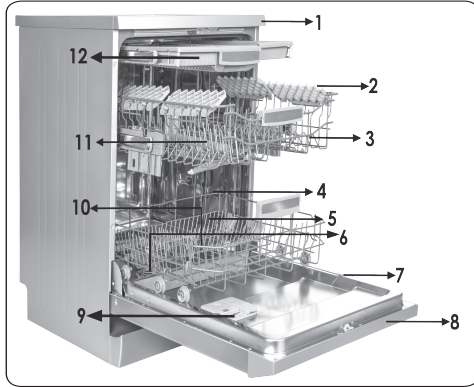

#### 3.1. General appearance

1. Worktop
2. Upper basket with racks
3. Upper spray arm
4. Lower basket
5. Lower spray arm
6. Filters
7. Rating plate
8. Control panel
9. Detergent and rinse-aid dispenser
10. Salt dispenser
11. Upper basket track latch
12. Upper Cutlery Basket
13. Turbo Drying Unit: This system provides better drying performance for your dishes.
14. Interior light: Provides illumination inside the dishwasher helping with loading and un-loading.

#### 3.2. Technical specifications

Capacity	14 place settings
Dimensions (mm)	
Height	850(mm)
Width	598(mm)
Depth	598(mm)
Net weight	62 kg
Operating voltage / frequency	220-240V 50 Hz,
Total current (A)	10(A)
Total power (W)	1900(W)
Water supply pressure	Maximum: 1 (Mpa) Minimum: 0.03 (Mpa)

## 4. BEFORE USING THE APPLIANCE

### 4.1. Preparing your Dishwasher for first use

- Make sure the electricity and supply water specifications match the values indicated in the installation instructions for the machine.
- Remove all packaging material inside the machine.
- Set the water softener level.
- Fill the rinse aid compartment.

### 4.2. Fill the salt (IF AVAILABLE)

To add softener salt, open the salt compartment cap by turning it counter clockwise. **(1)** **(2)** At first use, fill the compartment with 1 kg salt and water **(3)** until it is almost overflowing. If available, using a funnel **(4)** will make filling easier. Replace the cap and close it. After every 20-30 Cycles add salt into your machine until it fills up (approx. 1 kg).

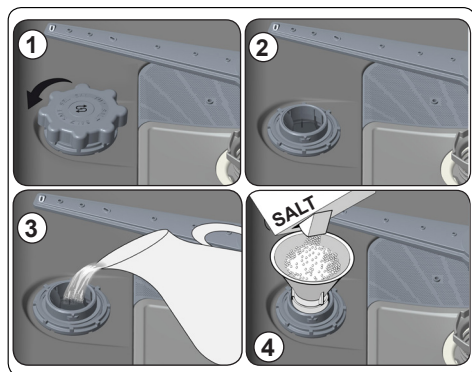







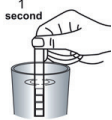
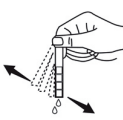

### Only add water to the salt compartment on first use.

Use softener salt specifically produced for use in dishwashers.

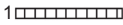
When you start your dishwasher, the salt compartment is filled with water, therefore put the softener salt in prior to starting your machine.

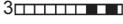
If the softener salt has overflowed and you do not start the machine immediately, run a short washing program to protect your machine against corrosion.

### 4.3. Test Strip

Run water through the tap (1min.)	Keep the strip in the water (1sec)	Shake the strip.	Wait (1min.)	Set the hardness level of your machine.
				1  2  3  4  5  6 

**NOTE:** The level is set 3 as default. If the water is well water or has a hardness level above 90 dF, we recommend that you use filter and refinement devices.

### 4.4. Water Hardness Table

Level	German dH	French dF	British dE	Indicator
1	0-5	0-9	0-6	L1 is shown on the display.
2	6-11	10-20	7-14	L2 is shown on the display.
3	12-17	21-30	15-21	L3 is shown on the display.
4	18-22	31-40	22-28	L4 is shown on the display.
5	23-31	41-55	29-39	L5 is shown on the display.
6	32-50	56-90	40-63	L6 is shown on the display.

### 4.5. Water Softener System

The dishwasher is equipped with a water softener which reduces the hardness in the mains water supply. To find out the hardness level of your tap water, contact your water company or use the test strip (if available).

### 4.6. Setting

- Enter the “Settings Menu” and select “2. Water Hardness: X”

2. Water Hardness: X

- The machine will display the last setting.
- Push the confirmation button and set the level by using up/down buttons.
- Push the confirmation button to save setting.

Stored

- Exit the menu.

### 4.7. Detergent usage

Only use detergents specifically designed for domestic dishwashers.

Add the recommended amount of detergent for the selected programme to ensure the best performance.

Keep your detergents in cool, dry places out of reach of children.

See the detergent manufacturer’s instructions for a further information.

#### 4.8. Filling the detergent

Push the latch to open the dispenser and pour in the detergent.

Close the lid and press it until it locks in place. The dispenser should be refilled just before the start of each programme. If the dishes are heavily soiled, place additional detergent in the pre-wash detergent chamber.

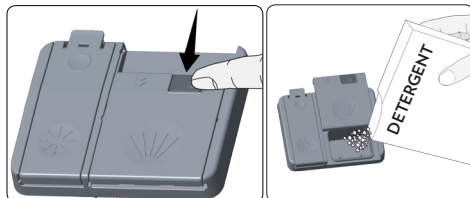

#### 4.9. Using combined detergents

These products should be used according to the manufacturer's instructions.

Never put combined detergents into the interior section or the cutlery basket.

Combined detergents contain not only the detergent but also rinse-aid, salt replacement substances and additional components depending on the combination.

We recommend you do not use combined detergents in short programmes.

Please use powder detergents in such programmes.

If you encounter problems when using combined detergents, please contact the detergent manufacturer.

When you stop using combined detergents, make sure that water hardness and rinse aid settings are set to correct level.

#### 4.10. Rinse-aid usage

Rinse-aid makes dishes sparkle and helps them to dry without spotting. Rinse-aid is required for stain-free utensils and clear glasses. Use only rinse-aid for domestic dishwashers.

#### 4.11. Filling the rinse-aid and setting

To fill the rinse aid compartment, open the rinse-aid compartment cap. Fill the compartment with rinse aid to the MAX level and then close the cap. Be careful not to overfill the rinse aid compartment and wipe up any spills.

**In order to change the rinse aid level, follow the below steps before turning on the machine:**

- Enter the "Settings Menu" and select "3. Rinse-aid: X"
- 3. Rinse-aid: X
- The machine will display the last setting.
- Push the confirmation button and set the level by using up/down buttons.
- Push the confirmation button to save setting.
- Stored Exit the menu.

The factory setting is "4".

If the dishes are not drying properly or are spotted, increase the level. If blue stains form on your dishes, decrease the level.

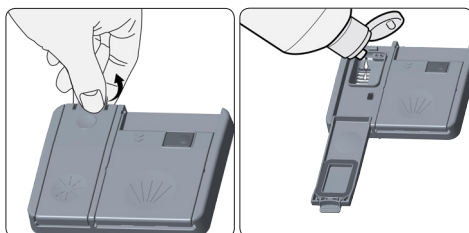

Level	Brightener Dose	Indicator
1	Rinse-aid not dispensed	r1 is shown on the display.
2	1 dose is dispensed	r2 is shown on the display
3	2 doses are dispensed	r3 is shown on the display.
4	3 doses are dispensed	r4 is shown on the display.
5	4 doses are dispensed	r5 is shown on the display.

## 4. LOADING YOUR DISHWASHER

For best results, follow these loading guidelines.

We recommend that you place large items (pots, pans, lids, plates and bowls) which are heavily soiled in the lower basket.

The upper basket is designed for delicate and lighter dishware such as glasses, coffee and tea cups and saucers. Position the dishes so that they will not get moved by the spray of water.

Cutlery should be placed in the cutlery basket. Items should be loaded individually into the appropriate slots with their handles downwards. Long utensils should be placed horizontally on the baskets.



**WARNING:** Take care not to obstruct the rotation of spray arms.

### 4.1. Recommendations

Remove any coarse residue on dishes before placing the dishes in the machine. Start the machine with full load.



Do not overload the drawers or place dishes in the wrong basket.



**WARNING:** Always place sharp utensils with the sharp point down and open utensils with their open



## Upper Basket

The upper basket includes a mechanism which enables the height of the basket to be adjusted up (1) or down (2) without having to remove the basket. Hold the basket on both sides and pull it up or push it down, ensuring both sides of the upper basket are in the same position.

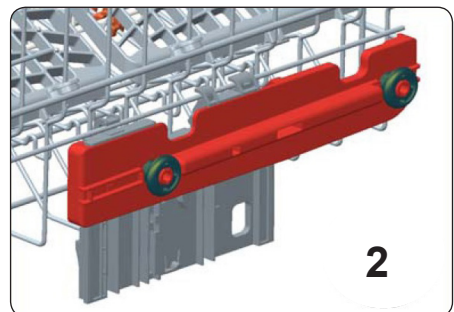
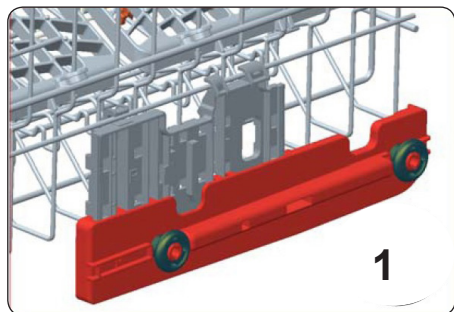

## Height Adjustable Rack (peg type)

The height adjustable racks enable glasses and cups to be placed on or under the racks. The racks can be adjusted to 2 different heights. Cutlery and utensils can also be placed on the racks horizontally.

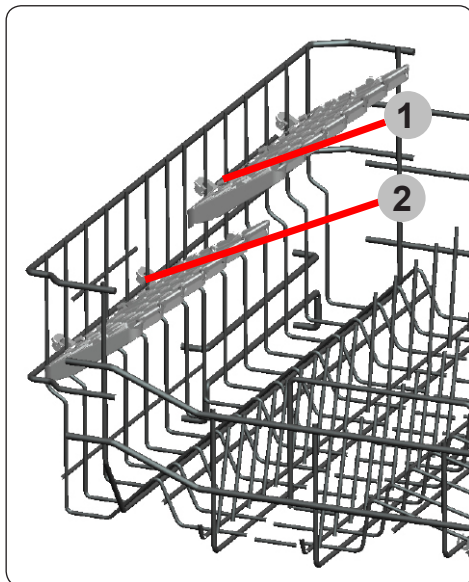

## Height Adjustable Rack (peg type)

The foldable racks in the upper basket enable the placement of large items such as pots and pans. Each section can be folded separately. The foldable racks can be either raised up or folded down.

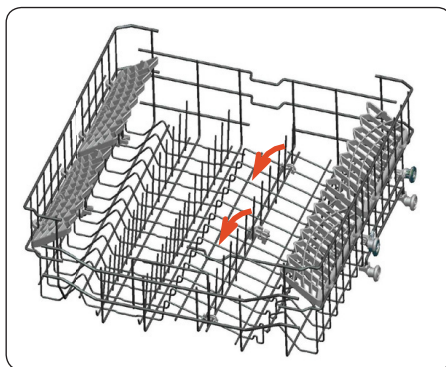

## Four Folding Racks (15 pc)

The folding racks allow easier placement of larger items, such as pots and pans. Each section can be folded up, or folded down, as shown in the images.

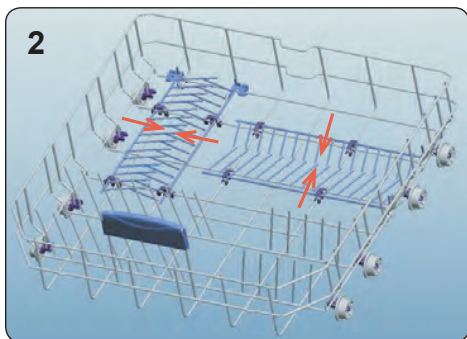
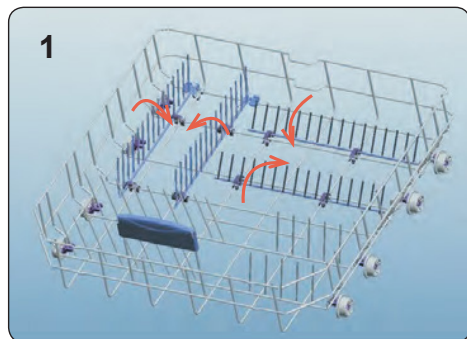

## Upper Cutlery Basket

The upper cutlery basket is designed for the placement of large and small cutlery and utensils.

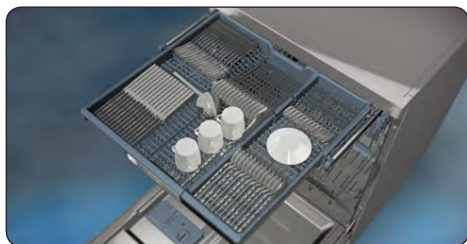

The basket is easily removed from the dishwasher, therefore allows ease of use when removing your items, along with the basket, after washing.



The upper cutlery basket is composed of two pieces that can be separately removed. Remove the left or right section of the cutlery basket in order to obtain more space for items in the upper basket.



**WARNING:** Knives and other sharp objects must be placed horizontally in the cutlery basket.

**5.2. Alternative Basket Loads**  
**Lower Basket**

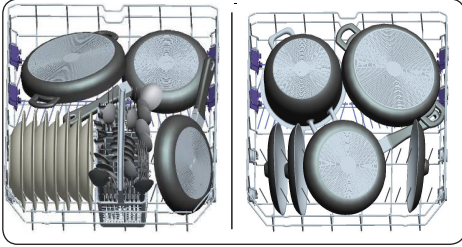

**Top basket**

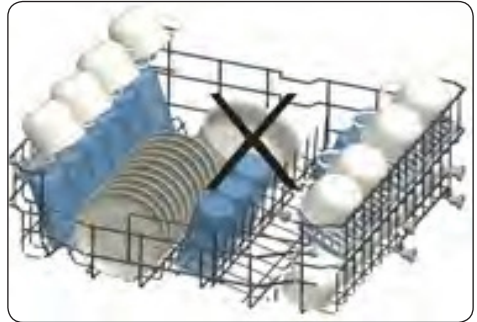
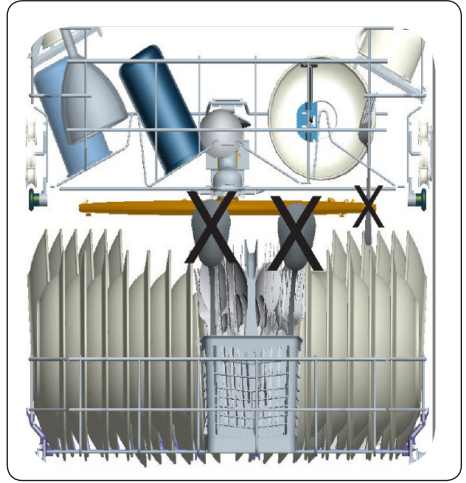
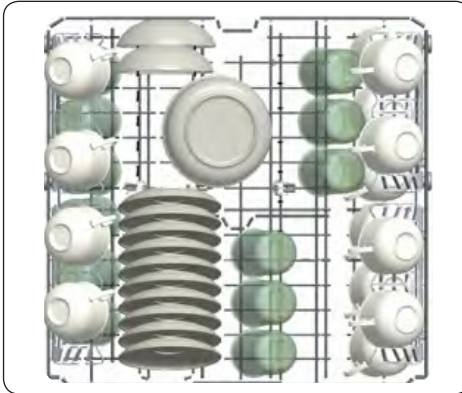

**Incorrect loads**

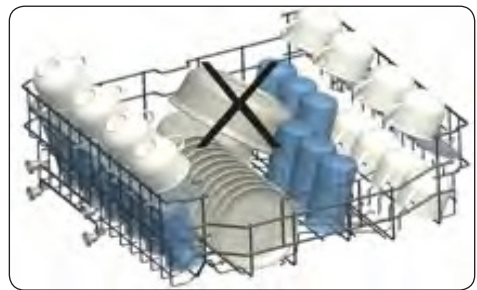
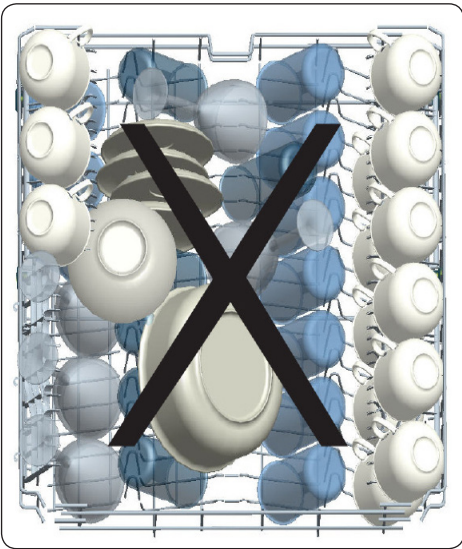

## 5. PROGRAMME TABLE

Programme	Detergent A: 5cm <sup>3</sup> B1: 15cm <sup>3</sup> B2: 25cm <sup>3</sup>	Duration (min)	Description
Prewash	-	15	To rinse heavily soiled dishes before a wash programme.
Mini 14'	-	14	Fast programme intended for recently used dishes which are lightly soiled. Suitable for 4 place settings.
Quick 30'	B2	30	Quick wash programme for lightly soiled dishes.
Eco (Reference)	A+B2	207	Standard programme for dishes which are used daily but are not heavily soiled.
Eco 5.4 lt	A+B2	177	Economy programme for dishes which are not heavily soiled. Reduced water consumption.
Dual Pro Wash	A+B2	113	For both lightly soiled delicate glassware and heavily soiled crockery at the same time.
Super 50'	A+B2	50	A faster programme for dishes which are used daily but are not heavily soiled.
Auto Delicate	B2	79-91	Automatic programme for delicate dishes which are not heavily soiled.
Auto Normal	A+B2	102-122	Automatic programme for dishes which are not heavily soiled.
Steam Wash	A+B2	161	Effective cleaning with steam for heavily soiled dishes.



**NOTE:** PROGRAMME DURATION MAY CHANGE ACCORDING TO THE AMOUNT OF DISHES, TAP WATER, AMBIENT TEMPERATURE AND SELECTED ADDITIONAL FUNCTIONS.

- Only use powder detergent in short programmes.
- Short programmes do not include a drying step.
- To assist drying, we recommend partially opening the door after the programme has finished.



## 7. THE CONTROL PANEL

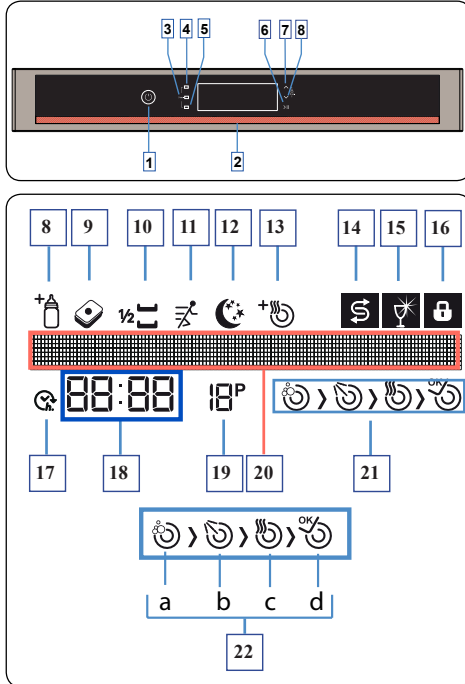



1. On/Off button
2. Confirmation button
3. Option button
4. Delay button
5. Start/Pause button
6. Up Selection button
7. Down Selection button
8. Extra Hygiene Indicator
9. Tablet Indicator
10. Half Load Indicator
11. Extra Fast Indicator
12. Extra Silent Indicator
13. Extra Drying Indicator
14. Salt Level Warning Indicator
15. Rinse Aid Level Warning Indicator
16. Child Lock Indicator
17. Delay Indicator
18. Remaining Time/Delay Time Indicator
19. Programme Number Indicator
20. Display Information Line
21. Washing Cycle Progress Indicators

- a- Washing Cycle symbol
- b- Rinse Cycle symbol
- c- Drying Cycle symbol
- d- End Cycle symbol

### Starting the Machine and Selecting a Programme

1. Press the Power On/Off button (1).
2. Select the programme most suitable for your dishes using the Up and Down Selection buttons (6, 7). These buttons are used to browse the Programme, Additional Functions, Delay and Settings menus.
3. Additional functions (8, 9, 10, 11, 12, 13) can also be selected using the Option button (3).

 **NOTE:** Select the Extra Hygiene function to increase the wash temperature, for a maximum hygiene washing operation. The Extra Hygiene Indicator (8) will illuminate.

 **NOTE:** Select the Tablet Detergent function when using a combined detergent that contains salt, rinse aid or other extras. The Tablet Detergent Indicator (9) will remain on for as long as it is selected.

 **NOTE:** Select the Half Load function to choose which area of the dishwasher contains dishes to be washed. You can select both baskets, the upper basket only, or the lower basket only. Press the button until the symbol corresponding to the basket containing the dishes to be washed illuminates. The Half Load Indicator (10) will illuminate while this function is in operation. Dishes placed in other areas will not be washed.

 **NOTE:** Select the Extra Fast function to decrease the duration of a programme, providing more economical water usage. The Extra Fast Indicator (11) will illuminate.

 **NOTE:** Select the Extra Silent function for a more sensitive and silent washing operation. The Extra Silent Indicator will illuminate (12).

 **NOTE:** Select the Extra Drying function to add extra drying steps to a programme in order to obtain drier dishes. The Extra Drying Indicator (13) will illuminate.

4. Press the Start/Pause button (5) to start the selected programme. The display will show 'Program Activated'.
5. The display (21) will show the symbols corresponding to the status of the programme in operation. While the Drying symbol is on, the machine will remain silent for 40 to 50 minutes.

 **NOTE:** When there is insufficient softening salt, the Salt Lack Warning Symbol (14) will illuminate to indicate the salt chamber needs filling.

 **NOTE:** When there is insufficient rinse aid, the Rinse Aid Lack Warning symbol (15) will illuminate to indicate the rinse aid chamber needs filling.

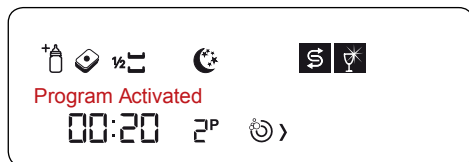

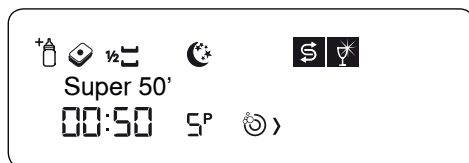

When a programme starts, the Display Information Line (20) will show the selected programme name, the Remaining Time Indicator (18) will show the washing time remaining, and the Programme Number Indicator (19) will show the number of the selected programme.





 **NOTE:** Do not open the door of the machine while it is operating. If you need to, press the Start/Pause button first. The display will show 'Program Paused'. You can then open the door. Take care when opening the door as steam will come out of the dishwasher. To resume the programme, close the door and press the Start/Pause button, 'Program Activated' will show on the display.

 **NOTE:** Leave the door of your machine slightly open at the end of a wash programme to speed up drying.

 **NOTE:** If the door of the machine is opened or the power is cut during operation, the programme will continue when the door is closed or the power returns.

 **NOTE:** If a power cut occurs or if the door is opened during drying, the programme will end. The machine will be ready for selecting a new programme.

 **NOTE:** A programme may take a different time to complete than that initially indicated depending on the water hardness. Your machine performs a water softening process depending on the mains water hardness. The total time of the programme also depends on the room temperature, the mains water temperature and the amount of dishes in the dishwasher.

 **NOTE:** Do not open the door before the End Cycle symbol illuminates.

### Option Compatibility

A programme may be adjusted according to your preferences by adding additional functions to the wash programme. The additional functions are not suitable for every programme. Please find below the functions suitable for the programmes. The function indicator will not illuminate if it is not compatible with a programme.

PROGRAMS	OPTIONS							
	Delay Start	Half Load (3 modes)	Tablet	ChildLock	ExtraFast	Extra Hygiene	Extra Silent	Extra Drying
Prewash	√	√	-	√	-	-	-	-
Jet Wash 14	√	√	-	√	-	-	-	-
Quick 30'	√	√	-	√	-	-	-	√
Eco 50°C	√	√	√	√	√	√	√	√
Eco 5,4 lt	√	√	√	√	√	√	√	√
Dual Pro Wash	√	√	√	√	√	√	√	√
Super 50'	√	√	√	√	-	√	-	√
Auto Delicate 30-50°C	√	√	√	√	-	√	-	√
Auto Normal 50-60°C	√	√	√	√	-	√	-	√
Steamwash 65°C	√	√	√	√	-	√	-	√

"-" Function cannot be selected.

"√" Function can be selected.

\*\* Programmes are indicated generally and may differ among models.

## 7.1. Adding Functions to a Programme

1. Select the appropriate wash programme for your dishes using the Up and Down Selection buttons.(6, 7).
2. Press the Option button (3) to enter the Additional Functions menu.
3. Navigate to the desired additional function using the Up and Down Selection buttons (6, 7).
4. Press the Confirmation button (2) to activate the additional function indicator (8, 9, 10, 11, 12, 13).

5. Press the Start/Pause button (5) to start the selected programme.

'Programme Activated' will appear on the display.

Options	Delay Start	Half Load (3 modes)	Tablet	Child Lock	Extra Fast	Extra Hygiene	Extra Silent	Extra Drying
Delay Start	OK	OK	OK	OK	OK	OK	OK	OK
Half Load (3 modes)	OK	OK	OK	OK	OK	OK	OK	OK
Tablet	OK	OK	OK	OK	OK	OK	OK	OK
Child Lock	OK	OK	OK	OK	OK	OK	OK	OK
Extra Fast	OK	OK	OK	OK	OK	OK	OK	OK
Extra Hygiene	OK	OK	OK	OK	OK	OK	OK	OK
Extra Silent	OK	OK	OK	OK	OK	OK	OK	OK
Extra Drying	OK	OK	OK	OK	OK	OK	OK	OK

## 7.2. Changing a Programme

Follow the steps below to change a programme while in operation.

-Press the Start/Pause button (5).  
'Programme Paused' will show on the display.

-Select a new programme using the Up and Down Selection buttons (6, 7).

-Press the Start/Pause button (5) to start the selected programme. 'Programme Activated' will show on the display.

-The new programme will resume the course of the old programme.

### 7.3. Cancelling a Programme

Follow the steps below to cancel a programme while in operation.

- Press and hold the Start/Pause button (5) for 3 seconds.

- The display will count down 3 seconds and show 'Program Cancelling..X'. When it finishes, 'Program Finished' will show on the display.

-You can then select another programme, additional functions or delay duration.

### Settings Menu

To enter the Settings Menu, press and hold the Option and Delay buttons (3, 4) for 3 seconds. The display will show 'Keep Pressing ..X'. When this reaches zero, the Settings Menu will show on the display. Use the Up and Down Selection buttons (6, 7) to navigate within the menu. To exit the menu, simultaneously press and hold the Option and Delay buttons (3, 4) for 3 seconds or use the Confirmation button (2) to select 'Exit Menu'.

The menu content is as follows:

1. Language
2. Water hardness
3. Volume
4. Brightness
5. Eco mode
6. Factory settings
7. Energy save
8. Exit menu ✓

#### 1. Language settings

Use the Up and Down selection buttons to select the Language option in the menu. The display will show '1.Language: X', where "X" represents the current set language. Press the Confirmation button (2) to activate the language selection. After selecting the new language, press the Confirmation button again to save it.

Available languages:

English Greek  
Turkish Croatian  
French Russian  
Deutsch Finnish  
Italian Norwegian

Nederlands Polish  
Swedish Czech  
Dansk Slovene  
Spanish Hungarian  
Portuguese

#### 2. Water hardness

Please see the section on water softening setting (page 15).

#### 3. Volume

Navigate to the '3- Volume' option using the Up and Down Selection buttons (6, 7). The display will show 'Volume: X' where X represents level 1, 2 or 3. Level 1 is the lowest volume and level 3 the highest. Press the Confirmation button (2) and select the desired volume level. Press the Confirmation button again to save the selection.

#### 4. Brightness

Navigate to the '4- Brightness' option using the Up and Down Selection buttons (6, 7). The display will show 'Brightness:X', where 'X' represents level 1, 2 or 3. Level 1 is the lowest brightness level, and level 3 the highest. Press the Confirmation button (2) and select the desired brightness level. Press the Confirmation button (2) again to save the selection.

#### 5. Eco mode

This mode saves energy by dimming the display brightness level after 30 seconds of no activity. Navigate to the '5- Eco mode' menu option using the Up and Down Selection buttons (6, 7). The display will show 'Ecomode: X', where 'X' is either 'YES' or 'NO'. Press the Confirmation button to activate 'X'.



## 6. Factory settings

Navigate to the '6- Factory settings' using the Up and Down Selection buttons (6, 7). Select this option using the Confirmation button (2) if you wish to restore all settings to the factory default. The display will show '6. Factory settings: X', where X represents 'YES' or 'NO'. Select an option for 'X' and press the Confirmation button again to save your selection. If the factory settings are restored, the machine will return to the following settings:

- |                   |           |
|-------------------|-----------|
| 1. Language       | : English |
| 2. Water hardness | : L3      |
| 3. Volume         | : L2      |
| 4. Brightness     | : L2      |
| 5. Eco mode       | : No      |

### Child Lock

After starting a programme, simultaneously press the Up and Down Selection buttons (6, 7) for 3 seconds. The display will show 'Keep Pressing..X' until the 3 seconds is complete. After this, the Child Lock will activate, 'Child Lock ON' will show on the display and the Child Lock Indicator (16) will illuminate. While the Child Lock is active, all buttons will deactivate.

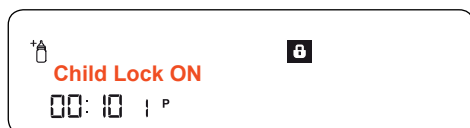

To cancel the Child Lock, simultaneously press the Up and Down Selection buttons (6, 7) for 3 seconds. The display will show 'Keep Pressing..X' until the 3 seconds is complete. After this, the Child Lock will deactivate, 'Child Lock OFF' will show on the display and the Child Lock Indicator (16) will switch off.



### Delayed Start (Snooze)

You may delay the starting time of the selected programme up to 24 hours. You can not make a delay setting after the programme starts.

1. Press the delay button (4)
2. Hour "00:00" is displayed on the display information line (20) and the delay symbol (17) starts flashing.
3. You may set the delay time with the selection buttons (6,7) to the desired time. The " " button (6) increases the time by 1 hour while "v" button (7) decreases by 1 hour.

By pressing the Start/Pause button, you may start the countdown until the delay time. The delay symbol (17) will continuously be illuminated during this period. Remaining Time/Delay Time (18) indicators display the delay time. After the countdown is over, the selected programme will start. The indicator screen will begin to show the time remaining until the end of the selected programme.

### Changing a Programme or Function on Delay

Press the Start/Pause button (5) to pause the machine. The delay timer will stop and 'program paused' and 'Delay timer active' will show on the display. If the buttons are pressed without pausing the machine, a warning will be displayed, such as 'Delay timer active' or 'invalid'.

If the Snooze is paused, programmes and additional functions may be selected.

Press the Start/Pause button (5) once more to resume the delay timer.

### To cancel or adjust the delay time while the machine is on Snooze

To reschedule the delay time, press the Start/Pause button (5) to stop the countdown. Then, press the Delay button (4) to open the Delay menu. Use the Up and Down Selection buttons (6, 7) to set a new delay time. Press the Start/Pause button (5) to start the new timer.

### To cancel the delay setting

Press and hold the Start/Pause button for 3 seconds. The display will show 'Program Cancelling .. X' for the 3 seconds. The delay time will be cancelled.

### Warning Messages

Your machine will provide feedback while

in operation. The following are examples of warning messages.

### Turn on the Tap

warning shown below will be displayed. Call

**When the above warning shows:**

1. Make sure water is available
2. Make sure the hydrant is closed
3. Call a qualified technician if this is not the case.

If an error occurs that you cannot fix, the warning shown below will be displayed. Call a qualified technician if this is the case.

### Call Service

You can find more information in the “FAILURE CODES AND WHAT TO DO” section in your user guide.

## 8. CLEANING AND MAINTENANCE

**Cleaning your Dishwasher is important to maintain the machine's service life.**

**Oil and lime may build up in your Dishwasher over time. If this occurs:**

- Fill the detergent compartment but do not load any dishes. Select a programme which runs at high temperature and run the Dishwasher empty. If this does not clean your Dishwasher sufficiently, use a cleaning agent designed for use with dishwashers.
- **Wipe the door seals regularly with a damp cloth to remove any accumulated residue.**

### 8.1. Cleaning machine and filters

Clean the filters and spray arms at least once a week. If any food waste remains on the coarse and fine filters, remove them and clean them thoroughly with water.

- a) Micro Filter      b) Coarse Filter  
c) Metal Filter

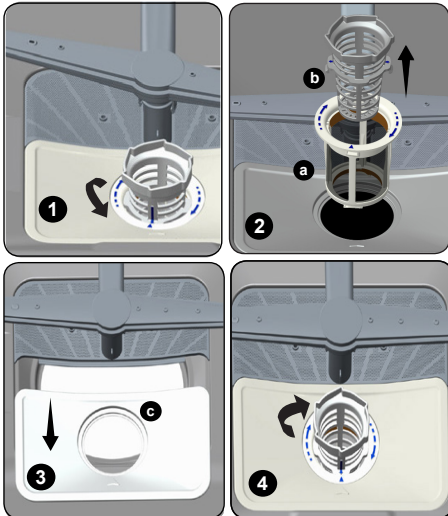

To remove and clean the filter combination, turn it counter clockwise and remove it by lifting it upwards (1). Pull the coarse filter out of the micro filter (2). Then pull and remove the metal filter (3). Rinse the filter with lots of water until it is free of residue. Reassemble

the filters. Replace the filter insert, and rotate it clockwise (4).

- Never use your Dishwasher without a filter.
- Incorrect fitting of the filter will reduce the washing effectiveness.
- Clean filters are necessary for proper running of the machine.

### 8.2. Spray arms

Make sure that the spray holes are not clogged and that no food waste is stuck to the spray arms. If there is any clogging, remove the spray arms and clean them under water. To remove the upper spray arm undo the nut holding it in position by turning it clockwise and pulling it downwards. Make sure that the nut is properly tightened when refitting the upper spray arm.

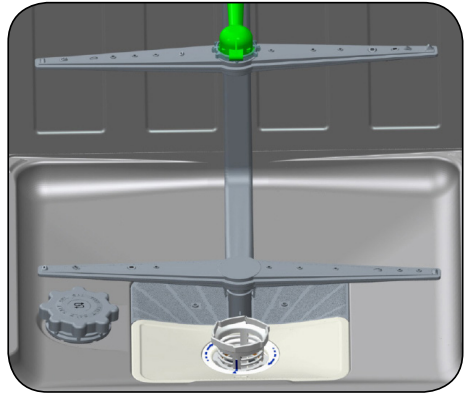

## 9. TROUBLESHOOTING

FAULT	POSSIBLE CAUSE	TROUBLESHOOTING
The programme does not start.	Your Dishwasher is not plugged in.	Plug your Dishwasher in.
	Your Dishwasher is not switched on.	Switch your Dishwasher on by pressing the On/Off button.
	Fuse blown.	Check your indoor fuses.
	Water inlet tap is closed.	Turn on the water inlet tap.
	Your Dishwasher door is open.	Close the Dishwasher door.
	Water inlet hose and machine filters are clogged.	Check the water inlet hose and machine filters and make sure they are not clogged.
Water remains inside the machine.	Water drain hose is clogged or twisted.	Check the drain hose, then either clean or untwist it.
	The filters are clogged.	Clean the filters.
	The programme is not finished yet.	Wait until the programme is finished.
Machine stops during washing.	Power failure.	Check mains power.
	Water inlet failure.	Check water tap.
Shaking and hitting noises are heard during a wash operation.	The spray arm is hitting the dishes in the lower basket.	Move or remove items blocking the spray arm.
Partial food wastes remain on the dishes.	Dishes placed incorrectly, sprayed water not reaching affected dishes.	Do not overload baskets.
	Dishes leaning each another.	Place dishes as instructed in the section on loading your dishwasher.
	Not enough detergent used.	Use the correct amount of detergent, as instructed in the programme table.
	Wrong wash programme selected.	Use the information in the programme table to select the most appropriate programme.
	Spray arms clogged with food waste.	Clean the holes in the spray arms with thin objects.
	Filters or water drain pump clogged or filter misplaced.	Check the drain hose and filters are correctly fitted.

FAULT	POSSIBLE CAUSE	TROUBLESHOOTING
Whitish stains remains on dishes.	Not enough detergent used.	Use the correct amount of detergent, as instructed in the programme table.
	Rinse aid dosage and/or water softener setting set too low.	Increase rinse aid and/or water softener level.
	High water hardness level.	Increase water softener level and add salt.
	Salt compartment cap not closed properly.	Check that the salt compartment cap is closed properly.
Dishes do not dry.	Drying option is not selected.	Select a programme with a drying option.
	Rinse aid dosage set too low.	Increase rinse aid dosage setting.
Rust stains form on the dishes.	Stainless-steel quality of the dishes is insufficient.	Use only dishwasher-proof sets.
	High level of salt in wash water.	Adjust the water hardness level using water hardness table.
	Salt compartment cap not closed properly.	Check that the salt compartment cap is closed properly.
	Too much salt spilled in the Dishwasher while filling it with salt.	Use funnel while filling salt to the compartment to avoid spillage.
	A poor mains grounding.	Consult a qualified electrician immediately.
Detergent remains in the detergent compartment.	Detergent was added when the detergent compartment was wet.	Make sure detergent compartment is dry before use.

## AUTOMATIC FAULT WARNINGS AND WHAT TO DO

TROUBLE CODE	POSSIBLE FAULT	WHAT TO DO
F5	Insufficient water	Make sure the water inlet tap is open and water is flowing
		Separate the inlet hose from the tap and clean the filter of the hose.
		Contact for service if the error continues.
F3	Continuous water input	Close the tap and contact for service.
F2	Inability to discharge water	Water discharge hose and filters may be clogged.
		Cancel the program.
		If the error continues, contact for service.
F8	Heater error	Contact for service.
F1	Overflow	Unplug the machine and close the tap.
		Contact for service.
FE	Faulty electronic card	Contact for service.
F7	Overheating	Contact for service.
F9	Divisor position error	Contact for service.
F6	Faulty heater sensor	Contact for service.

## 10. PRACTICAL INFORMATION

- When the machine isn't in operation:
  - Disconnect the plug and close the tap.
  - Leave the door slightly open to prevent odour formation.
- Select the dry option to remove water droplets.
- Place dishes in the machine properly to achieve the best energy consumption, washing and drying performance. Please see the programme and consumption table for more information.
- Rinse dirty dishes before placing them in the dishwasher.
- Only use the Prewash programme when necessary.
- Do not place the machine near a refrigerator because it will reach high temperatures.
- If the machine is located in an area that is at risk of freezing, close the tap, disconnect the inlet hose from the tap and drain the water inside the hose and the machine completely.





# Service & Support

Visit Our Website  
[sharphomeappliances.com](http://sharphomeappliances.com)

**SHARP**

Be Original.

52277448 R35