



CI Z9F&#% Z8D

CI Z9F&#% Z8D

Dishwasher

EN

User Manual

SHARP

Be Original.

CONTENTS

CHAPTER -1: EXPLANATION OF PRODUCT	
Technical specifications	5
Conformity with the standards and test data	5
CHAPTER -2: SAFETY INFORMATION AND RECOMMENDATIONS	
Recycling	6
Safety information	6
Recommendations	8
Items not suitable for dishwashing	8
CHAPTER -3: INSTALLING THE MACHINE	
Positioning the machine	8
Water connections	9
Water inlet hose	9
Water outlet hose	9
Electrical connection	10
Fitting the machine under counter	11
Prior to using the machine	13
CHAPTER -4: PREPARING THE MACHINE FOR USE	
The importance of water decalcification	13
Filling with salt	13
Testing strip	13
Adjusting salt consumption	14
Detergent usage	14
Filling the detergent compartment	14
Combined detergent	15
Filling with rinse aid and making the setting	15
CHAPTER -5: LOADING YOUR DISHWASHER	
Dish rack	16
Alternative basket loads	18
CHAPTER -6: PROGRAMME DESCRIPTIONS	
Programme items	19
CHAPTER -7: SWITCHING ON THE MACHINE AND SELECTING A PROGRAMME	
Selection of Program and Starting of the Machine	23
Programme follow-up	24
Adding Additional Functions to the Program	25
Changing a programme /Changing a programme with resetting	26
Settings Menu	27
CHAPTER -8: MAINTENANCE AND CLEANING	
Filters	31
Spray arms	31
Hose filter	31
CHAPTER -9: FAILURE CODES AND WHAT TO DO IN CASE OF FAILURE	32
CHAPTER -10: PRACTICAL AND USEFUL INFORMATION	33

CHAPTER -1: EXPLANATION OF PRODUCT

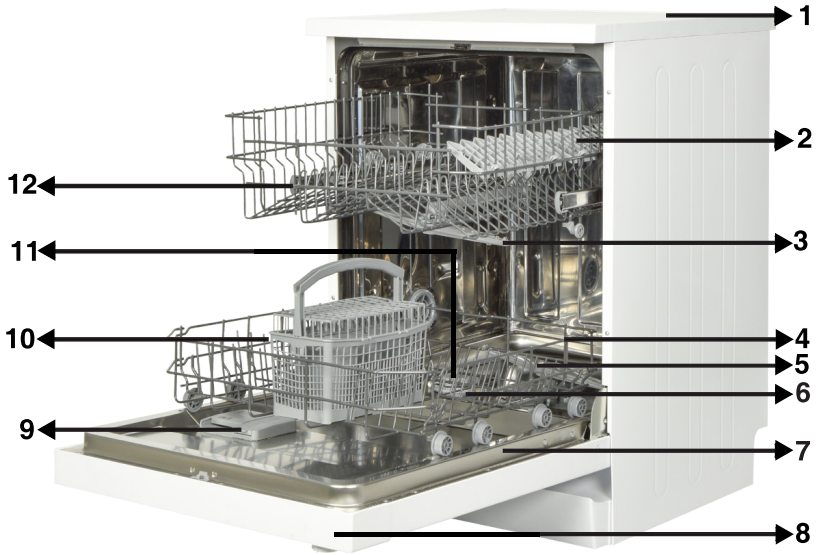

1. Worktop

2. Upper basket with racks

3. Upper spray arm

4. Lower basket

5. Lower spray arm

6. Filters

7. Rating plate

8. Control Panel

9. Detergent and rinse-aid dispenser

10. Cutlery basket

11. Salt dispenser

12. Upper basket track latch



→ 13

Turbo Drying Unit:

This system provides better drying performance for your dishes.



→ 14

Ceiling Spray Arm:

It provides better washing for the dishes at upper basket.



→ 15

Interior light :

Provides illumination inside the dishwasher helping with loading and un-loading.

CHAPTER -1: TECHNICAL SPECIFICATIONS

Technical specifications

Capacity	12 place settings
Height	850 mm
Height (without worktop)	820 mm
Width	598 mm
Depth	598 mm
Net Weight	55 kg
Electricity input	220-240 V, 50 Hz
Total Power	1900 W
Heating Power	1800 W
Pump Power	100 W
Drain Pump Power	30 W
Water supply pressure	0.03 MPa (0,3 bar)-1 MPa (10 bar)
Current	10 A

Conformity with the standards and Test data / EU Declaration of Conformity

This product meets the requirements of all applicable EU directives with the corresponding harmonised standards, which provide for CE marking.

Please visit www.sharphomeappliances.com for an electronic copy of this user manual.

Recycling

- The recyclable materials are used in certain components and packaging.
- Plastic parts are marked with international abbreviations: (>PE< , >PS< , >POM< , >PP< ,)
- Cardboard parts have been produced from recycled paper which should be disposed of into waste paper collection containers for recycling.
- Such materials are not suitable for garbage bins. They should be delivered to recycling centres instead.
- Contact relevant centres in order to obtain information on methods and points of disposal.

Safety Information

When you take delivery of your machine

- If you see any damage on your machine's packaging, please notify your retailer.
- Unwrap the packaging materials as indicated and dispose of them in accordance with the rules.

The points to pay attention during machine installation

- Choose a suitable, safe and level place to install your machine.
- Carry out the installation and connection of your machine by following the instructions.
- We recommend that the machine is installed by an authorised installer, and should only be serviced by an approved technician.
- Only original spare parts should be used with the machine.
- Before installing, be sure that the machine is unplugged.
- Check whether the indoor electrical fuse system is connected according to the regulations.
- All electrical connections must match values on the rating plate.
- Be sure that the machine does not stand on the electricity supply cable.
- Never use an extension cord or a multiple socket for making a connection. The plug should be easily accessible after installation.
- After installation, run it unloaded for the first time.

In daily use

- This machine is for household use; do not use it for any other purpose. Commercial usage of the dishwasher will void the guarantee.
- Do not use detergents and rinse aids that are not specifically designed for dishwashers. Improper use of such items may invalidate the warranty.
- Due to risk of explosion, do not put any chemical dissolving agents such as solvents into the machines' washing section.
- Check whether plastic items are heat-resistant before washing.

CHAPTER -2: SAFETY INFORMATION AND RECOMMENDATIONS

- This appliance can be used by children aged from 8 years and above and persons with reduced physical, sensory or mental capabilities or lack of experience and knowledge if they are supervised or have been given instruction concerning use of the appliance in a safe way and understand the hazards involved. Children should not play with the appliance. Cleaning and user maintenance shall not be made by children without supervision.
- Do not put unsuitable and heavy items above the basket capacity into your machine. SHARP will not be responsible for any damage on the inner parts.
- The door should not be opened whilst the machine is operating. A safety device will ensure that the machine stops if opened.
- To avoid accidents, do not leave the door open.
- Place knives and other sharp-ended objects in the cutlery basket in bladedown position.
- If the supply cord is damaged, it must be replaced by SHARP, or its service agent.
- If EnergySave option is selected as “Yes”, the door will be opened at the end of the program. Do not force the door closed to avoid harming the auto door mechanism, for 1 minute. The door must be open for 30 minutes to dry effectively (in models an with auto door opening system).

Warning: Do not stand in front of the door after the auto-open signal sounds.

For your children’s safety

- After removing the machine’s packaging, make sure that the packaging material is out of reach of children.
- Do not allow children to play with or start the machine.
- Keep children away from detergents and rinse aid.
- Keep children away from the machine while it is open because there may still be residues of cleaning substances inside the machine.
- Be sure that your old machine does not pose any threat to your children. Children are known to have become locked in old machines. To prevent such a situation, break your machine’s door lock and tear off the electrical cables.

In case of malfunction

- Any repair performed by anyone other than authorized service personnel will invalidate your warranty.
- Prior to any repair work on the machine, be sure that the machine is isolated from the mains. Switch off the fuse or unplug the machine. Do not pull by the cable when unplugging. Make sure to turn off the water tap.

Recommendations

- For energy and water saving, remove coarse residues on your dishes before placing the dishes into the machine. Start your machine after having fully loaded it.
- Use the pre-wash programme only when necessary.
- Place hollow items such as bowls, glasses and pots into the machine in such a way that they will face down.
- You are not recommended to overload your machine or load it in a way other than that which is indicated.

Items not suitable for dishwashing:

- Cigarette ash candle leftovers, polish, paint, chemical substances, ironalloy materials.
- Forks, spoons and knives with wooden or bone, or ivory or nacre-coated handles; glued items, items soiled with abrasive, acidic or base chemicals.
- Plastic items that are not heat-resistant, copper or tin-coated containers.
- Aluminium and silver objects (they may discolour, become dull).
- Certain delicate glass types, porcelain with ornamental printed patterns as they fade even after the first wash; certain crystal items as they lose their transparency over time, cutlery that is not heat-resistant, lead crystal glasses, cutting boards, items manufactured with synthetic fibre.
- Absorbent items as sponges or kitchen rags are not suitable for dishwashing.

Warning: Take care to buy dishwasher-proof sets in your future purchases.

INSTALLING THE MACHINE

Positioning the machine

When determining the installation place, choose an accessible place for easy loading and unloading of the dishes.

Do not put your machine in any location where there is the possibility of the room temperature falling below 0°C.

Before positioning, take the machine out of its packaging by following the warnings located on the package.

Position the machine close to a water tap or drain. You need to site your machine, taking into consideration that its connections cannot be altered once they are made.

Do not grip the machine by its' door or panel in order to move it.

Take care to leave sufficient clearance from all sides of the machine for moving it back and forth during cleaning.

Make sure that the water inlet and outlet hoses do not get squeezed while positioning the machine. Also, make sure that the machine does not stand on the electrical cable.

Adjust the machines' adjustable feet so that it can stand level and balanced. Proper positioning of the machine ensures problem-free opening and closing of the door.

CHAPTER -3: INSTALLING THE MACHINE

If the door of machine does not close properly, check if the machine is stable on the floor. If not, adjust the feet and ensure its' stable position.

Water connection

Indoor plumbing must be suitable for installing a dishwasher. Also, we recommend that you fit a filter at the entrance of your property so as to avoid any damage to your machine because of contamination (sand, clay, rust etc.) that might be occasionally carried in through the mains water supply or the indoor plumbing, and to prevent such complaints as yellowing and formation of deposits after washing.

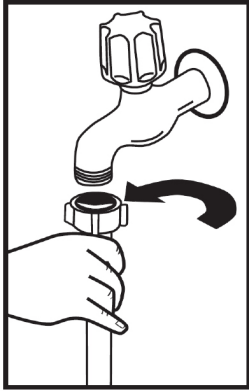

Water inlet hose

Do not use the water inlet hose of your old machine. Use the new one supplied with your machine instead. If you connect a new or long - unused water inlet hose to your machine, run water through it for a while before making the connection. Connect the water inlet hose directly to the water inlet tap. The pressure supplied by the tap should be at a minimum of 0.03 Mpa and at a maximum of 1 Mpa. If the water pressure is above 1 Mpa, a pressure-relief valve should be fitted inbetween.

After making connections, the tap should be turned on fully and checked for water tightness. For safety purposes, we recommend that you turn off the water inlet tap when the machine is not going to be used for an extended period of time.

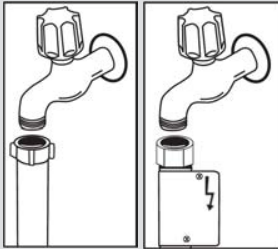

NOTE: An Aquastop water etc. spout is used in some models. With Aquastop, a potentially dangerous tension exists. Do not cut the Aquastop water spout. Do not let it get folded or twisted.

Water outlet hose

The water drain hose can be connected either directly to the water drain hole or to the sink outlet spigot. Using a special bent pipe (if available), the water can be drained directly into the sink via hooking the bent pipe over the edge of the sink. This connection should be between 50 and 110 cm from the floor plane.

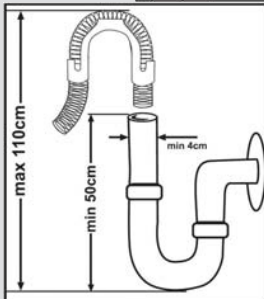

CHAPTER -3: INSTALLING THE MACHINE

Warning: When a drain hose longer than 4 m is used, the dishes might remain dirty. In that case, SHARP will not accept responsibility.

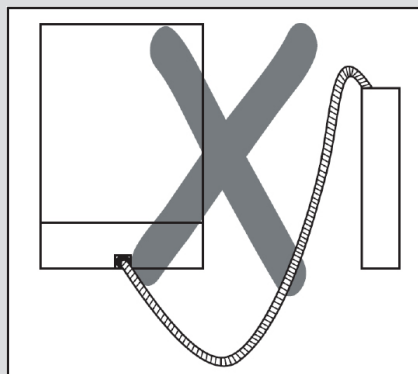
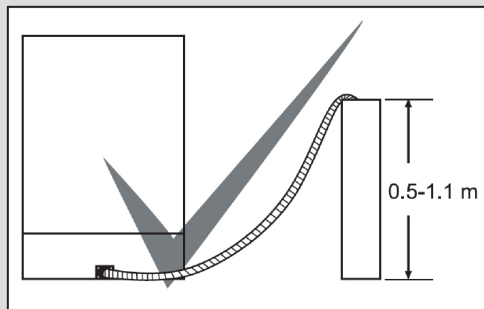

Electrical connection

The earthed plug of your machine should be connected to an earthed outlet supplied by suitable voltage and current. If there is no earthing installation, have a competent electrician to carry it out. In case of usage without earthing installed, our company will not be responsible for any loss of usage that might occur. The indoor fuse current value should be 10-16 A. Your machine is set according to 220-240 V. If the mains voltage in your location is 110 V, connect a transformer of 110/220 V and 3000 W inbetween.

The machine should not be plugged in during positioning. Always use the coated plug supplied with your machine. Running in low voltage will cause a decline in washing quality. The machines' electrical cable should be replaced by an authorised service or an authorised electrician only. Failure to do so may lead to accidents. For safety purposes, we recommend that you disconnect the plug when the machine is not going to be used for an extended period of time. In order avoid electric shocks, do not unplug when your hands are wet.

When disconnecting your machine from the mains supply, always pull from the plug. Never pull the cord itself.

Fitting the machine undercounter

If you wish to fit your machine undercounter, check whether you have sufficient space under your countertop and whether the wiring-plumbing is suitable to do so. **1** If you decide that the space under the countertop is suitable for fitting your machine, remove the worktop as shown in the illustration. **2**

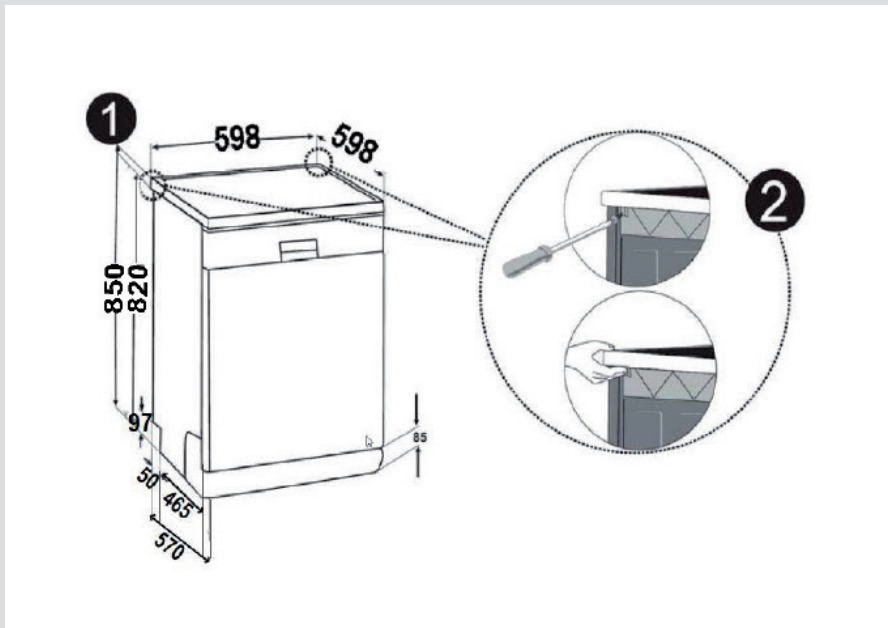

Warning: The surface which you place the machine under when removing its worktop has to be stable to avoid balance problems.

To remove the worktop, remove the screws that hold the worktop which are located at the rear of the machine; then push the front panel 1 cm from the front side towards the rear and lift it.

CHAPTER -3: INSTALLING THE MACHINE

Adjust the machine's feet according to the slope of the floor.**3** Fit your machine by pushing it undercounter without letting the hoses get crushed or bent.**4**

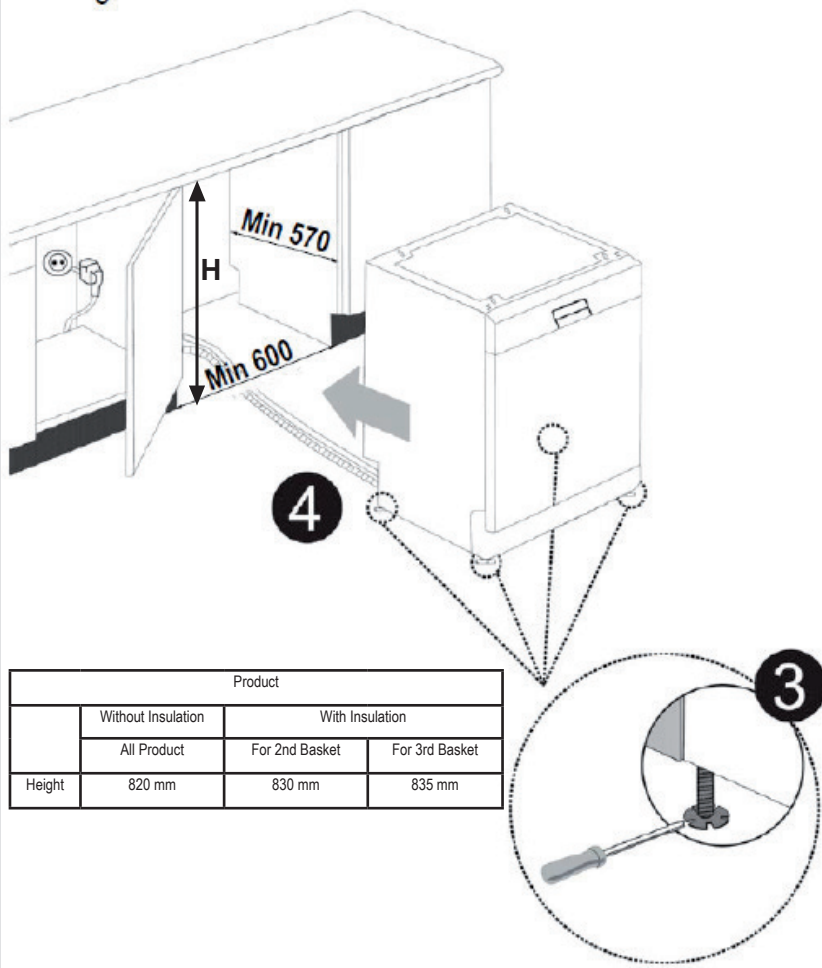

Warning: After removal of the worktop, the machine should be placed in such a closed place of which dimensions are shown at fig.

CHAPTER -4: PREPARING THE MACHINE FOR USE

Prior to using the machine for the first time

- Check whether the electricity and supply water specifications match the values indicated by the installation instructions for the machine.
- Remove all packaging materials inside the machine.
- Set the water softener.
- Add 1 kg salt into the salt compartment and fill with water up to a level at which it will almost overflow.
- Fill the rinse aid compartment.

PREPARING THE MACHINE FOR USE

The importance of water decalcification

For a good washing function, the dishwasher needs soft, i.e. less calcareous water. Otherwise, white lime residues will remain on the dishes and the interior equipment. This will negatively affect your machine's washing, drying and shining performance. For this reason, a softener system used on dishwashers. The softener system has to be refreshed so that it operates with the same performance also during the next wash. For this purpose, dishwasher salt is used.

Filling with salt (IF AVAILABLE)

Use softener salt specifically produced for use in dishwashers. To add softener salt, first remove the lower basket and then open the salt compartment cap by turning it counter clockwise. (1) (2) At first use fill the compartment with 1kg salt and water (3) at overflowing level if available. Using a funnel (4) will make filling easier. Refill the cap and close it. After every 20th-30th wash, add salt into your machine until it fills up (approx. 1 kg) Fill the salt compartment with water at first use only. We recommend to use smallgrained or powder softener salt. Do not put table salt into your machine. Otherwise, the function of the softener compartment may decrease over time. When you start machine, the salt compartment gets filled with water. There fore, put the softener salt prior to starting your machine. This way, overflowing salt gets immediately cleaned up through the wash operation. If you will not wash any dishes immediately after putting salt, then run a short washing program with an empty machine in order to avoid corrosion on your machine due to the salt overflow while filling in the salt container. In order to understand whether or not the amount of

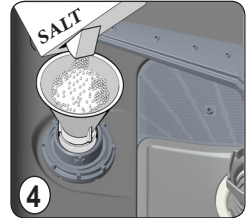
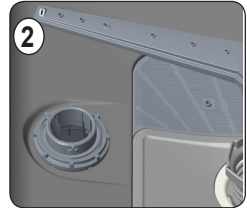

softener salt in machine is sufficient, check the transparent section on the salt compartment cap. There is sufficient salt if the transparent section is green. Salt has to be added if it is not green.

Testing strip

The washing effectiveness of your machine depends on the softness of the tap water. For this reason, your machine is equipped with a system that reduces the hardness in mains water supply. The washing effectiveness will increase when the system is correctly set. To find out the water hardness level of water in your area, contact your local water board or determine water hardness level by using the test strip(if available).

Open the testing strip	Run water through your tap for 1 min.	Keep the testing strip in water for 1.sec.	Shake the testing strip after taking it out of water	Water for 1 min.	Make your machine's water hardness setting according to the result obtained through the testing strip.																		
					<table border="1"> <tr> <td>Level 1</td> <td></td> <td>No Lime</td> </tr> <tr> <td>Level 2</td> <td></td> <td>Very low lime content</td> </tr> <tr> <td>Level 3</td> <td></td> <td>Low lime content</td> </tr> <tr> <td>Level 4</td> <td></td> <td>Medium lime content</td> </tr> <tr> <td>Level 5</td> <td></td> <td>Lime content</td> </tr> <tr> <td>Level 6</td> <td></td> <td>High lime content</td> </tr> </table>	Level 1		No Lime	Level 2		Very low lime content	Level 3		Low lime content	Level 4		Medium lime content	Level 5		Lime content	Level 6		High lime content
Level 1		No Lime																					
Level 2		Very low lime content																					
Level 3		Low lime content																					
Level 4		Medium lime content																					
Level 5		Lime content																					
Level 6		High lime content																					

CHAPTER -4: PREPARING THE MACHINE FOR USE

Adjusting salt consumption

Water hardness level	German hardness level dH	French hardness level dF	British hardness level dE	Hardness Level Indicator
1	0-5	0-9	0-6	L1 is seen on display.
2	6-11	10-20	7-14	L2 is seen on display.
3	12-17	21-30	15-21	L3 is seen on display.
4	18-22	31-40	22-28	L4 is seen on display.
5	23-31	41-55	29-39	L5 is seen on display.
6	32-50	56-90	40-63	L6 is seen on display.

Adjust the water hardness setting of your machine according to the level specified on the test strip.

NOTE: Hardness level is adjusted to level 3 as a factory setting.

Adjust water hardness setting of your machine according to the level specified on the test track.

Enter the menu to change water hardness. In order to enter the menu settings, hold the option and delay buttons for 3 seconds. The display will show an expression ("**Keep Pressing .. X**") to let you know how many more seconds you have to hold the button. When this number is zero, you will see the "**Settings Menu**" on the display.

After entering the menu, select "**2. Water Hardness: X**" by using up/down selection buttons. The number "**X**" will be similar to the following values : L01,L02,L03,L04,L05,L06.

2. Water Hardness: X

Then, press the confirmation button (3), the "**X**" value will start flashing. Select the desired value by using up/down selection buttons. Press the confirmation button (3) to save the settings; the expression "**Stored**" will appear on the display.

Stored

Your settings will be saved and the display automatically returns to the water hardness setting menu. In order to exit the menu, you may hold the option and delay buttons for 3 seconds like you did when entering the menu or you may select the seventh row (**7. Exit Menu**) in the menu with the confirmation button.

Detergent usage

Use a detergent specifically designed for use in domestic dishwashers.

You can find powder, gel, and tablet detergents that have been designed for household dishwashers.

Detergent should be put into the compartment prior to starting the machine. Keep your detergents in cool, dry places out of reach of your children.

Do not fill detergent into the detergent compartment more than required; otherwise it may cause scratches on your glasses as well as lead to a poorly dissolved detergent.

Should you need more information concerning the detergent you will use, contact detergent manufacturers directly.

Filling the detergent compartment

Push the latch to open the detergent container as shown in the image. 1 The detergent pod has level lines inside. The detergent pod can take totally 40 cm³ detergent. Open the dishwasher detergent and pour into the larger compartment b 25 cm³ if dishes are heavily soiled or less 15 cm³. 2 If dishes have been kept dirty for a very long time, dried food wastes on them or overly loaded the dishwasher, pour a 5cm³ detergent into the prewash compartment and start machine. You may have to add more detergent into your machine, depending on the degree of soil and on the water hardness level in your area.

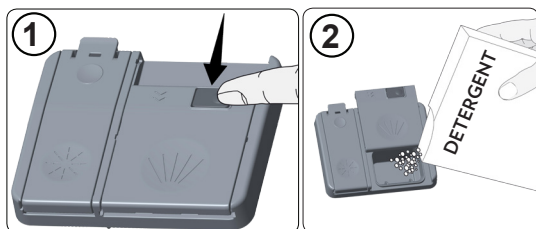

CHAPTER -4: PREPARING THE MACHINE FOR USE

Combined detergents

Combined detergents may include various properties. Before using the detergent, read the instructions carefully. Generally combined detergents produce sufficient results under certain conditions only.

Points to consider when using this type of products:

- Check the specifications of the product whether it is combined or not.
- Check if the detergent used is appropriate for the hardness of mains water.
- Observe the instructions of products on packaging.
- Always put the tablets into the detergent compartment in the detergent dispenser.
- You need to contact the manufacturers and find out about the suitable conditions of use.
- If you use appropriate products, they ensure savings in salt and/or rinse aid consumption.
- The scope of warranty for your machine does not cover any complaints caused by the use of these types of detergents.

Recommended usage: If you want to obtain better results while using combined detergents, add salt and rinse aid into your machine and adjust the water hardness setting and the rinse aid setting to the lowest position.



Solubility of the tablet detergents produced by different companies can vary depending on the temperature and time. Therefore, it is not recommended to use such detergents in short programs. It is more suitable to use powder detergents in such programs.

Warning: Should any problem, which you have not encountered before arise with the use of this type of detergent, contact the detergent manufacturer directly.

When you stop using combined detergents

- Fill the salt and rinse aid compartments.
- Adjust the water hardness setting to the highest position and run an empty-wash.
- Adjust the water hardness level.
- Make the suitable rinse aid setting.

Filling with rinse aid and making the setting

To fill the rinse aid compartment, open the rinse-aid compartment cap. Fill the compartment with rinse aid to the MAX level and then close the cap. Be careful not to overfill the rinse aid compartment and wipe up any spills.

In order to change the rinse aid level, follow the below steps before turning on the machine:

- Enter the "Settings Menu" and select "3. Rinse-aid: X"
- 3. Rinse-aid: X
- The machine will display the last setting.
- Push the confirmation button and set the level by using up/down buttons.
- Push the confirmation button to save setting.
- Stored Exit the menu.

The factory setting is "4".

If the dishes are not drying properly or are spotted, increase the level. If blue stains form on your dishes, decrease the level.

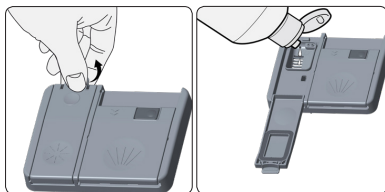

Level	Brightener Dose	Indicator
1	Rinse-aid not dispensed	r1 is shown on the display.
2	1 dose is dispensed	r2 is shown on the display
3	2 doses are dispensed	r3 is shown on the display.
4	3 doses are dispensed	r4 is shown on the display.
5	4 doses are dispensed	r5 is shown on the display.

CHAPTER-5: LOADING YOUR DISHWASHER

LOADING YOUR DISHWASHER

Place dishes properly into the machine.

There are two separate baskets to load dishes into your machine. The lower basket is for round and deep items. The upper basket is for thin and narrow items. You are recommended to use the cutlery grid in order to obtain the best result.

To avoid any possible injuries, long-handle and sharp-pointed dishes with their sharp points facing down or horizontally on the baskets.

Warning: Place your dishes into your machine in a way that they will not prevent the upper and lower spray arms from spinning.

Dish rack

You can place different sizes of glasses under these racks thanks to the adjustable height feature. You can use racks in 2 different heights.

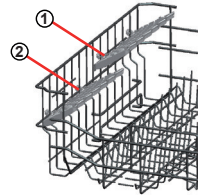

Foldable racks

Foldable racks on the upper basket are designed in order to let you place big items easier such as pots, pans, etc. If required, each part can be folded separately, or all of them can be folded and larger spaces can be obtained. To adjust the foldable racks, either raising them upwards, or fold them down.

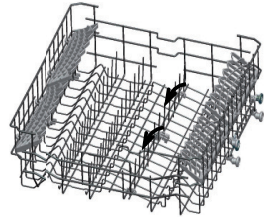

Top basket height adjustment while it is full

The basket height adjustment mechanism on the top basket of your machine is designed to let you adjust the height of your top basket upwards or downwards, without removing it from your machine when it is full, and create large spaces at the top or bottom area of your machine as needed. The basket of your machine is set to upper position in factory settings. In order to raise your basket, hold it from both sides and pull it upwards. In order to lower it, hold it from both sides again, and leave it. In the loaded basket adjustment mechanism, make sure that both sides are in the same position. (up or down)

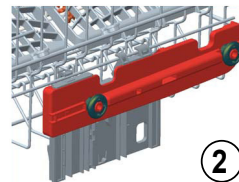
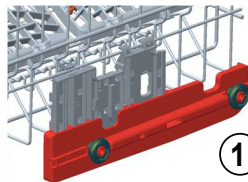
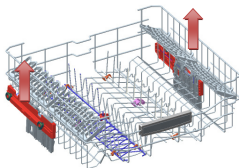

Lower basket

Folding racks

In the lower basket of the machine, there are four folding racks that are designed to allow you to make it easier to place big items such as pots, pans, etc. If required, each part can be folded separately, or all of them can be folded and larger spaces can be obtained. To adjust them, raise them upwards, or fold down.

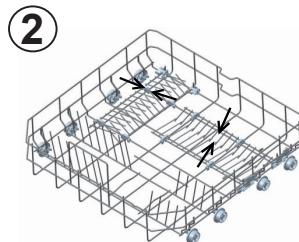
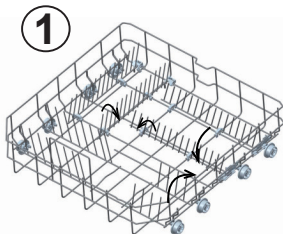

CHAPTER-5: LOADING YOUR DISHWASHER

The movable cutlery basket can be slid between the front and rear wires of the bottom basket. Thanks to this feature, the cutlery basket can be placed at the desired location.



CHAPTER-5: LOADING YOUR DISHWASHER

Alternative basket loads

Lower Basket

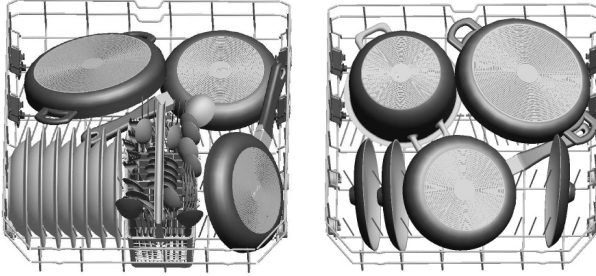

Top basket

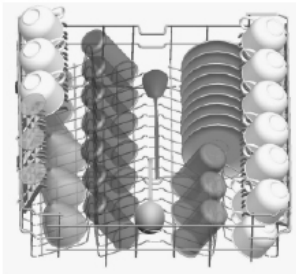

Faulty loads

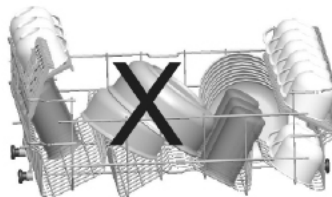
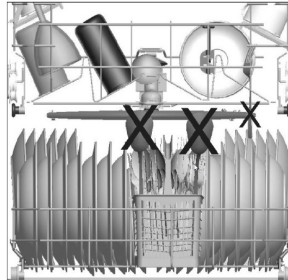
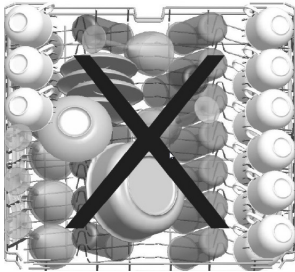

Important Note for Test Laboratories

For detailed information on performance tests, please contact following address: "dishwasher@standardtest.info". In your email, please provide the model name and serial number (20 digits) which you can find on the appliance door.

CHAPTER -6: PROGRAMME DESCRIPTIONS

Programme items

Programme No					
Name of Program	Pre-washing	**Jet Wash 14'	Quick 30'	Eco 50°C	Super 50'
Washing Temperature	-	35° C	40° C	50° C	65° C
Type of Food Fragment	Fresh less dirty, coffee, milk, tea	Less dirty, coffee, milk tea, not kept for long	Fresh coffee, milk, tea, cold meat, vegetables	Fresh coffee, milk, tea, cold meat, vegetables	Tarried soup, sauce, pastry, egg, rice, potato and meals cooked in oven, fried food
Level of Contamination	- small	small	small	Medium	Medium
Amount of Detergent B: 25 cm ³ / 15 cm ³ A: cm ³	-	**A	B	A+B	A+B
	Prewash	35°C Wash	40°C Wash	Prewash	65°C Wash
	End	Hot Rinse	Cold Rinse	50°C Wash	Warmish Rinse
		End	Hot Rinse	Hot Rinse	Hot Rinse
			End	Dry	End
				End	
Program Period (minutes)	15	14	30	270	5 0
Power Consumption (kW hour)	0,02	0.57	0,74	0,80	1,29
Water Consumption (liters)	4,2	7,7	10,9	9,0	10,7

Dual Wash : The delicate dishes on the upper basket are washed at a lower pressure and the heavily soiled dishes on the lower basket are washed at a higher pressure by the help of a variable-speed engine. Therefore, you can wash both delicate/less soiled dishes and heavily soiled dishes at the same time.

*Off mode and left on mode tests in accordance with EN 62301 must be carried out with Eco mode brightness level.

Jetwash 14 min programme can be used for not kept for long, less dirty dishes. It is suitable for dishes of four persons. Jetwash 14 min. Only powder detergent should be used.

CHAPTER -6: PROGRAMME DESCRIPTIONS

Programme items

Programme No					
Name of Program	Daily	Dual Wash 65°C	Oto 30°C - 50°C	Oto 50°C - 60°C	Oto 60°C - 70°C
Washing Temperature	60°C	65°C	30-50°C	50-60°C	60-70°C
Type of Food Fragment	Soup,pastry, egg, rice, potato and meals cooked inoven, fried food	Soups, sauces,pasta, eggs, pilaf, potato and oven dishes, fried foods,kept for long	Automatically adjust the washing time with temperature and amount of water by determining the soil level of dishes		
Level of Contamination	Medium	high	small	high	high
Amount of Detergent B: 25 cm 3 / 15 cm3 A: cm 3	A+B	A+B	B	A+B	A+B
	Prewash	40°C Wash	Washing steps are determined automatically according to the level of soil.		
	60°C Wash	65°C Wash			
	Warmish Rinse	45°C Wash			
	Hot Rinse	Hot Rinse			
	End	Dry			
		End			
Program Period (minutes)	99	113	79-91	102-122	107-179
Power Consumption (kW hour)	1,38	1,43	0,82	1,18	1,30
Water Consumption (liters)	14.9	15,4	10,6-17,7	10,9-18,5	12,3-24,6

Warning: In Jetwash 14 min, Fast 30 min and Super 50 min programmes, there is no drying step. Values above have been tested according to related standards in lab condition. These values may vary due to environment conditions (mains voltage, water pressure, water inlet temperature and ambient temperature).

CHAPTER -7: SWITCHING ON THE MACHINE AND SELECTING A PROGRAMME

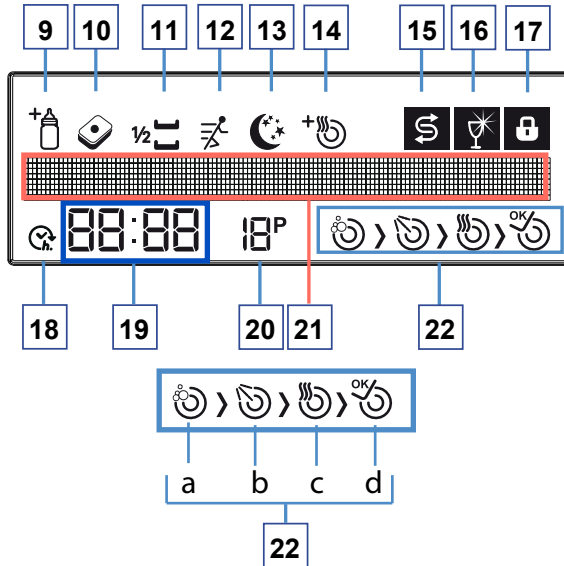
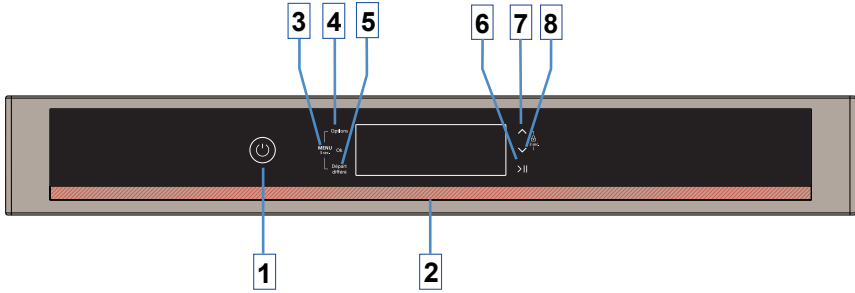

- 1-On/Off
- 2-Door Handle
- 3-Confirmation Button
- 4-Option Button
- 5-Delay Button
- 6-Start/Pause button
- 7-Up Selection Button
- 8-Down Selection Button
- 9-Extra Hygiene Indicator
- 10-Tablet Indicator
- 11-Half Load Indicator
- 12-Extra Fast Indicator
- 13-Extra Silent Indicator
- 14-Extra Drying Indicator
- 15-Salt Level Warning Indicator

- 16-Rinse Aid Level Warning Indicator
- 17-Child Lock Indicator
- 18-Delay Indicator
- 19-Remaining Time/Delay Time Indicator
- 20-Program Number Indicator
- 21-Display Information Line
- 22-Washing cycle progress indicators
- a-Washing Cycle Symbol
- b-Rinse Cycle Symbol
- c-Drying Cycle Symbol
- d-End Cycle Symbol

CHAPTER -7: SWITCHING ON THE MACHINE AND SELECTING A PROGRAMME

BUTTONS

Power On/Off Button (1)

When you press the on/off button, the machine is energized and the display shows the last used program; in the off position, the LEDs on the display are off.

Door Handle (2)

Please use the door handle to open-close the door of your machine.

Confirmation Button (3)

Confirms (saves) your additional functions and settings.

Option Button (4)

Allows you to use the functions in the additional functions menu.(9-10-11-12-13-14)

Delay Button (5)

Delays the starting time of the program you have selected (1-24 hours).You may see the delay time in the Remaining Time/Delay Time Indicator (19).When the delay button is pressed, Delay Indicator (18) is seen on the display.

Start/Pause Button (6)

When you press the Start/Standby Button, the selected program starts and washing symbol (a) appears on the display.You may follow the washing phases on the display. (22-a-b-c-d)

Up / Down Buttons (7) (8)

Allows you to browse in Program, Additional functions, delay and settings menus.

Additional Functions

Extra Hygiene function (9)

You may select this function in order to obtain extra hygiene and a cleaner washing process by altering the water temperature and washing time of the program you have selected.

Tablet Detergent function (10)

Please use the Tablet Detergent function while using salt, rinse agent and combined deterjents with extra properties.

Half Load Function (11)

Using the Half load function, three sorts of washing up can be done those being lower basket, upper basket and both baskets.

If you have little amount of dishes in your machine and if you have to wash them, you can also activate the semi-filling function for some programs. If you have dishes in both baskets, select the half load function and select the position in which both images are highlighted.

If you have dishes only in the upper basket, select the position in which the upper image is illuminated.Thus, washing up shall be done only on the upper basket of your machine.

If you have dishes only in the lower basket select the position in which the lower image is illuminated. Thus, washing up shall be done only on the lower basket of your machine. In using this feature, make sure that there are no dishes in the upper basket.

Extra Fast Function (12)

Washes the dishes with more pressure, thus shortens the time of the selected program and provides economical water usage.

Extra Silent Function (13)

Washes the dishes with less pressure, thus provides more sensitive and silent washing.

Extra Drying function (14)

With extra drying function, you may add extra drying steps to your program and thus obtain drier dishes.

Warning Indicators

Salt Level Warning Indicator (15)

In order to understand whether the salt in your machine is sufficient or not, please check the salt level warning display. If this display is illuminated, fill the salt section.

Rinse Agent Level Warning Indicator (16)

In order to understand whether the rinse agent in your machine is sufficient or not, please check the rinse agent level warning display.If this display is illuminated, fill the rinse agent section.

CHAPTER -7: SWITCHING ON THE MACHINE AND SELECTING A PROGRAMME

Selection of Program and Starting of the Machine

1- Press Power On/Off switch.

Note: Select your washing program appropriate for your dishes by the help of the program items page in the user guide.

2- You may select the washing program by using up/down (7,8) selection buttons.

Note: You may follow the program time in the time indicator. (19)

3- If necessary, you may select additional functions by using option button (4).(9-10-11-12-13-14)

4- You may start the programme by pressing the Start/Pause button. **"Program Activated"** will appear on the display and the selected program will start.

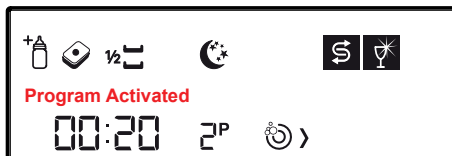

When the program starts, you may see the name of the selected program in the Display information line (21), remaining washing time in the remaining time indicator (19) and the program number of the selected program in the program number indicator (20).



Note: Try not to open the door of the machine while it is operating; if you absolutely need to, stop the programme by pressing Start/Pause button.

"Program Paused" will appear on the display. Once you see this text, you may open the door. Steam might come out when you open the door – be careful.

You may resume the programme after closing the door and pressing the Start/Pause button again. When you press the Start/Pause button, **"Program Activated"** will appear on the display.

CHAPTER -7: SWITCHING ON THE MACHINE AND SELECTING A PROGRAMME

Program Follow-up

You can follow the progress by the help of the program follow-up symbols on the display.(22 - a,b,c,d).



As the washing proceeds, respectively Washing and Drying symbols will be illuminated. When the drying symbol is on, the machine remains silent for about 40-50 minutes.



Do not open the door before the completion indicator light is on. When the programme ends, Completion indicator light is illuminated.



When the program you have selected starts, you may see the estimated remaining time in the time indicator.

NOTE: A few minutes after the program finishes and the Completion lamp is illuminated, you may open the door slightly and leave it ajar in order for the drying process to be faster.

NOTE: If the machine door is opened or a power failure occurs during washing, the machine will proceed from where it stopped after the door is closed or power is restored.

NOTE : If a power cut occurs or if the door is opened during drying, the programme ends. The machine will be ready for selecting a new programme.

NOTE: Your machine performs water softening process in accordance with the mains water hardness. For this reason, in some washes, the remaining time near the end of the programme might be different from that indicated in the beginning. The total time of the programme also depends on the room temperature, mains water temperature and amount of dishes.

CHAPTER -7: SWITCHING ON THE MACHINE AND SELECTING A PROGRAMME

Adding Additional Functions to the Program

You may change the program according to your preferences by adding additional functions to the washing program. The washing programs have been designed so as to obtain the best cleaning considering the type of smear, amount of smear and properties of the washing materials. The additional functions were developed in order to save time, water and electricity and thus allow you to wash your dishes more conveniently. For example, if you think your dishes are slightly dirty, you may select the Fast function (12) and make your washing process more economical in terms of time and water.

If you are going to use a multipurpose detergent, you obtain better performance by selecting tablet detergent (10) function.

If you live in a place where electricity is cheaper to use at night, you might select the silent function (13) and wash your dishes more economically and silently; this function was developed also for a more sensitive washing process.

Additional functions are not suitable for every program; you might find below the functions suitable for the programs. For the programs not suitable for functions, you will see that the function indicator is not illuminated.

PROGRAMS	OPTIONS							
	Delay Start	Half Load (3 modes)	Tablet	Child Lock	Extra Fast	Extra Hygiene	Extra Silent	Extra Drying
Prewash	X	X	-	X	-	-	-	-
Jet Wash 14	X	X	-	X	-	-	-	-
Quick 30'	X	X	-	X	-	-	-	X
Eco 50°C	X	X	X	X	X	X	-	X
Dual Wash	X	X	X	X	X	X	X	X
Super 50'	X	X	X	X	-	X	-	X
Eco 5,5 lt	X	X	X	X	X	X	X	X
Auto Normal 50-60°C	X	X	X	X	-	X	-	X
Auto Delicate 30-50°C	X	X	X	X	-	X	-	X
Daily 60 ° C	X	X	X	X	-	X	-	X

“-“ Function cannot be selected “x” function can be selected.

** Programmes are indicated generally and might differ among models.

CHAPTER -7: SWITCHING ON THE MACHINE AND SELECTING A PROGRAMME

In order to add additional functions to the program;

1- Select the appropriate washing program for your dishes using the up/down buttons(7,8) after pressing the option button.

2- Enter the additional functions menu (4) by pressing the option button. After selecting the additional function using up/down buttons (7,8), illuminate the additional function indicators (9-10-11-12-13-14) by pressing the confirmation button.

3- You may start the programme by pressing the Start/Standby button. **"Programme activated"** will appear on the display.

Some functions cannot be selected at the same time; please refer to the scheme below

Options	Delay Start	Half Load (3 modes)	Tablet	Child Lock	Extra Fast	Extra Hygiene	Extra Silent	Extra Drying
Delay Start		OK	OK	OK	OK	OK	OK	OK
Half Load (3 modes)	OK		OK	OK	OK	OK	OK	OK
Tablet	OK	OK		OK	OK	OK	OK	OK
Child Lock	OK	OK	OK		OK	OK	OK	OK
Extra Fast	OK	OK	OK	OK		-	-	OK
Extra Hygiene	OK	OK	OK	OK	-		-	-
Extra Silent	OK	OK	OK	OK	-	-		OK
Extra Drying	OK	OK	OK	OK	OK	-	OK	

Changing the Program

If you want to change a washing programme after it has been started;

1- Pause the programme by pressing the Start/Pause (6) button. **"Programme paused"** will appear on the display.

2- Select the desired programme by pressing the selection buttons (7,8).

3- You may start the programme by pressing the Start/Pause button again. **"Programme activated"** will appear on the display.

Note: The new program starts from the step where the previous program was left. Note: If you want the new program to start from the beginning, you must first cancel the previous program and then select a new one.

Cancelling the Program

1- Hold the Start/pause button (6) for 3 seconds to cancel a program.

2- The display will show an expression (**"Program Cancelling ..X"**) to let you know how many more seconds you have to hold the button. 1 minute after you do this, **"Program Finished"** will appear.

3- After this warning, you may select an additional function or time setting. Note: Depending on the step where the cancelled program was left, there may be detergent leftovers within the machine or on the dishes.

CHAPTER -7: SWITCHING ON THE MACHINE AND SELECTING A PROGRAMME

Settings Menu

In order to enter the Settings Menu, hold the option and delay buttons for 3 seconds. The display will show an expression ("Keep Pressing .X") to let you know how many more seconds you have to hold the button. When this number is zero, you will see the Menu settings on the display. You may navigate within the menu by using the selection buttons. In order to exit the menu, you may hold the option and delay buttons for 3 seconds like you did when entering the menu or you may select the seventh row in the menu with the confirmation button.

The menu content is as follows:

1. Language
2. Water Hardness
3. Volume
4. Brightness
5. Ecomode
6. Factory Settings
7. Energy save
8. Exid Menu ↙

1- Language settings

After you enter the menu settings, use up/down selection buttons to select the language. You will see an expression (1. Language: X) in which "X" is the current language. After that, press the confirmation button to activate the language selection and after selecting the new language, save it by pressing the confirmation button again.

Available languages that you can select :

English	Greek	Nederlands	Polish
Turkish	Croatian	Swedish	Czech
French	Russian	Dansk	Slovene
Deutsch	Finnish	Spanish	Hungarian
Italian	Norwegian	Portuguese	

2- Water hardness setting

You may find this in the section where water softening setting is explained. (page 15)

3- Volume level

You may adjust the level of your machine's audible alarms here. After entering the menu, select the "3- Volume " by using the selection buttons. Here you will see "Volume: X" (X:L1,L2,L3). L1 is the lowest, L3 is the highest volume level. After pressing the confirmation button, activate "X", select the desired noise level and save the selection by pressing the confirmation button once more.

4- Brightness level

You may adjust the level of your machine's display brightness here. After entering the menu, select the "4- Brightness" by using the selection buttons. Here you will see "brightness :X" (X:L1,L2,L3). L1 is the lowest, L3 is the highest brightness level. Select the desired brightness level and save the selection by pressing the confirmation button, activate "X" and confirmation button once more.

5- Eco mode

This mode saves energy by minimizing the display brightness level after 30 seconds of non - operation. After entering the menu, select the "5- Eco mode" by using the selection buttons. Here you will see "Ecomode: X" (X: YES or NO). After pressing the confirmation button, activate "X"; you might use your machine with Eco mode on or off.

6- Factory Settings

In order to discard all the settings you made and restore the factory settings, select the "6- Factory settings" by using the selection buttons. Here you will see "6. Factory settings: X" (X: yes or no). After pressing the confirmation button, activate " X "; you might save your selection by selecting "Yes" or "No" expression and pressing the confirmation button again. When you restore the factory settings, the machine will return to the following settings:

- 1- Language : English
- 2- Water hardness setting : L3
- 3- Volume : L2
- 4- Brightness : L2
- 5 -Eco Mode : No

CHAPTER -7: SWITCHING ON THE MACHINE AND SELECTING A PROGRAMME

Child Lock:

You might prevent others from modifying your settings while the machine is in operation. After starting the programme, press the up selection button (7) and down selection button (8) at the same time for 3 seconds. This screen will inform you as to how many seconds you need to hold the buttons by "Keep Pressing..X". When this time is over, the child lock is activated, "Child Lock ON" appears on the screen and the indicator (17) is illuminated. When the child lock is active, all the buttons are deactivated.



In order to cancel the child lock, press the up selection button (7) and down selection button (6) at the same time for 3 seconds. This screen will inform you as to how many seconds you need to hold the buttons by "Keep Pressing..X". When this time is over, the child lock is cancelled, "Child Lock OFF" appears on the screen and the indicator (17) is off.



Delayed Start:(Snooze)

You may delay the starting time of the selected programme up to 24 hours. You can not make a delay setting after the programme starts. In order for you to be able to make a delay setting, the selected programme needs not to be in operation.

- 1- Press the delay button (5)
- 2- Hour "00:00" is displayed on the display information line (19) and the delay symbol (18) starts flashing.
- 3- You may set the delay time with the selection buttons (7,8) to the desired time. The "v" button (7) increases the time by 1 hour while "v" button (8) decreases by 1 hour.

By pressing the Start/Pause button, you may start the countdown until the delay time. The delay symbol (18) will continuously be illuminated during this period. Remaining Time/Delay Time (19) indicators display the delay time. After the countdown is over, the selected programme will start. The indicator screen will begin to show the time remaining until the end of the selected programme.

Changing the programme or function on delay:

Pause the machine by pressing the Start/Pause button; the countdown will stop and the "program paused" and "Delay timer active" appear on screen. If you press the buttons without pausing the machine, you will receive warnings such as "Delay timer active" or "invalid".

After pausing the snooze, you may select programmes and add functions to the programme it was told in relevant topics.

By pressing the Start/Pause button once more, start the countdown until the delay time.

If you want to cancel or make a new time setting when the machine is on snooze;

If you want to reschedule the delay time, stop the countdown by pressing the start/standby button. Press the delay button to enter the delay menu; set the new Delay time by pressing the selection buttons. Start the countdown by pressing the Start/Standby button.

If you want to cancel the delay setting, hold the Start/Pause button for 3 seconds. The display will inform you how many seconds you need to hold the button by "Program Cancelling .. X". This way, the delay countdown is cancelled.

Warning Messages:

Your machine provides feedbacks while in operation;



CHAPTER -7: SWITCHING ON THE MACHINE AND SELECTING A PROGRAMME

When above warning is seen;

- 1- Make sure that the water is not cut
- 2- Make sure that the hydrant is open
- 3- If both are true, call the qualified technician.

Whenever an error which you cannot fix occurs, above warning will be displayed. When you see it, call the qualified technician.



Call Service

When your machine gives the above warnings, the error codes are specified after the definition. You might find related information in the **"FAILURE CODES AND WHAT TO DO IN CASE OF FAILURE"** section in your user guide.

CHAPTER -7: SWITCHING ON THE MACHINE AND SELECTING A PROGRAMME

Inner Light option:

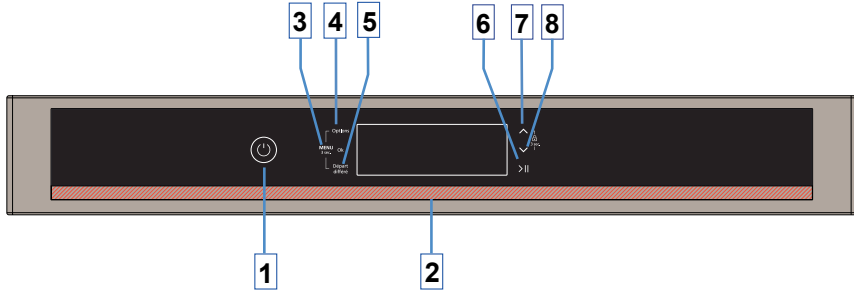

Machine must be ON position during activation and deactivation of inner light modes. Note: open or close position of the door is not important

How to change from “ECO MODE” to “NORMAL MODE” for Inner Light option:

- * First energize the machine via main switch (if it is in OFF position).
- * First energize the machine via main switch (if it is in OFF position).
- * Select “5. Eco mode” sub menu by using “up” and “down” buttons and press confirmation button to enter in this sub menu.
- * In “5. Eco mode” sub menu, select “Eco mode: NO” condition and press confirmation button to confirm the selection. Now “Normal Mode” is selected for inner light option.
- * After “Normal Mode” is selected, the inner light will be ON as long as the machine is energized and machine door is open.

How to change from “NORMAL MODE” to “ECO MODE” for Inner Light option:

- * First energize the machine via main switch (if it is in OFF position).
- * Press Option (4) and Delay (5) buttons simultaneously for 3 seconds to enter the “Settings Menu”.
- * Select “5. Eco mode” sub menu by using “up” and “down” buttons and press confirmation button to enter in this sub menu.
- * In “5. Eco mode” sub menu, select “Eco mode: YES” condition and press confirmation button to confirm the selection. Now “ECO Mode” is selected for inner light option.
- * After “Eco Mode” is selected, the inner light will be ON for 4min after machine door is opened and then turns OFF. If any user intervention occurs such as pressing buttons, Eco Mode cycle starts from beginning (inner light is ON for 4min and then becomes OFF again)

Note: Factory setting for inner light are set to “ECO MODE : YES”.

CHAPTER -8: MAINTENANCE AND CLEANING

Cleaning the machine regularly prolongs the machine's service life.

Oil and lime scale may accumulate in the machine's washing section. In case of such accumulation;

-Fill the detergent compartment without loading any dishes into the machine, run the machine at high temperature. If this does not work, use special cleansing materials.

Cleaning the seals in the machine door,

-Wipe the seals regularly by using a dampened cloth.

Cleaning machine,

Clean the filters and spray arms at least once a week.

Unplug your machine and turn off its tap before starting the cleaning.

Wipe with a fine cleaning material and a dampened cloth.

Filters

If any food wastes have remained on the coarse and fine filters, remove the filters and clean them thoroughly under the water tap.

a. Micro Filter

b. Coarse Filter

c. Metal/Plastic Filter

To remove and clean the filter combination, turn it counter clockwise and take it out by lifting upwards. **1**

Pull and remove the metal/plastic filter. **3** Then pull the coarse filter out of the micro filter. **2** Rinse it with lots of water under the tap. Refit the metal/plastic filter. Insert the coarse filter into the micro filter in a way that the marks will correspond to one another. Attach micro filter into the metal/plastic filter and turn to the direction of arrow and it is locked when the arrow on micro filter can be seen from across. **4**

- Never use your dishwasher without a filter.
- Incorrect fitting of the filter will reduce the washing effectiveness.
- Clean filters are very important in terms of the proper running of the machine.

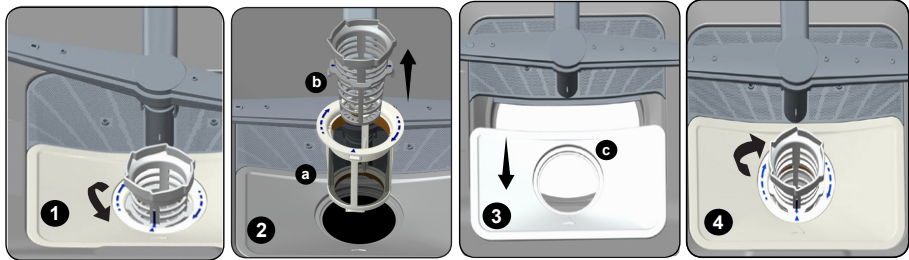

Spray arms

Check the holes for the upper and lower spray arms. If there is any clogging, remove the spray arms and clean them under water.

You can remove the lower spray arm by pulling it upwards, while the upper spray arm nut can be removed by turning the nut to the left. Be sure that the nut is perfectly tightened when refitting the upper spray arm.

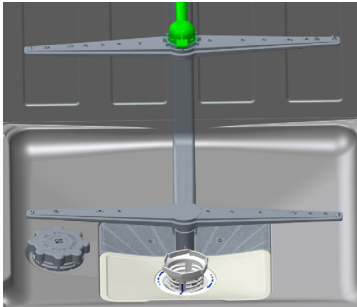

Hose filter

Check the filter and the hose from time to time and clean them to prevent yellowing and formation of deposits after washing. To clean the filter, first turn off your tap and then remove the hose. After removing the filter from the hose, clean it under the tap. Insert the cleaned filter back into its place inside the hose. Refit the hose.

CHAPTER -9: FAILURE CODES AND WHAT TO DO IN CASE OF FAILURE

ERROR CODE	ERROR DESCRIPTION	CONTROL
F5	Inadequate water supply	<ul style="list-style-type: none"> • Make sure the water input tap is totally open and that there is no water cut. • Close the water input tap, separate the water input hose from the tap and clean the filter at the connection end of the hose. • Restart your machine, contact for service if the error resumes.
F3	Error of continuous water input	<ul style="list-style-type: none"> • Close for tap. • Contact for service.
F2	The waste water in the machine cannot be discharged.	<ul style="list-style-type: none"> • Water discharge hose is clogged. • The filters of your machine might be clogged. • Power off-on your machine and activate the program cancellation command. • If the error continues, contact for service.
F8	Heater error	<ul style="list-style-type: none"> • Contact for service.
F1	Alarm is active against water overflow	<ul style="list-style-type: none"> • Power off your machine and close for tap. • Contact for service.
FE	Faulty electronic card	<ul style="list-style-type: none"> • Contact for service.
F7	Overheating error (temperature in the machine is too high)	<ul style="list-style-type: none"> • Contact for service.
F9	Divisor position error	<ul style="list-style-type: none"> • Contact for service.
F6	Faulty heater sensor	<ul style="list-style-type: none"> • Contact for service.

If one of program monitor lights is on and start/Pause light is on and off,

Your machines' door is open, shut the door.

If the programme won't start

- Check if the plug is connected.
- Check your indoor fuses.
- Be sure that the water inlet tap is turned on.
- Be sure that you have closed the machine door.
- Be sure that you switched off the machine by pressing the Power On / Off button.
- Be sure that the water inlet filter and the machine filters are not clogged.

If the control lamps won't go out after a wash operation

The Power On/Off button is released yet.

If detergent residues are left in the detergent compartment

Detergent has been added when the detergent compartment was wet.

If water is left inside the machine at the end of the programme

- The water drain hose is clogged or twisted.
- The filters are clogged.
- The programme is not finished yet.

If the machine stops during a wash operation

- Power failure.
- Water inlet failure.
- Program can be on standby mode.

If shaking and hitting noises are heard during a wash operation

- Dishes placed incorrectly.
- Spray arm hitting the dishes.

If there are partial food wastes left on the dishes

- Dishes placed incorrectly into the machine, sprayed water did not reach related places.
- Basket overly loaded.
- Dishes leaning against one another.
- Very small amount of detergent added.
- An unsuitable, rather weak wash programme selected.
- Spray arm clogged with food wastes.
- Filters clogged.
- Filters incorrectly fitted.
- Water drain pump clogged.

CHAPTER -10: FAILURE CODES AND WHAT TO DO IN CASE OF FAILURE

If there are whitish stains on the dishes

- A very small amount of detergent is being used.
- Rinse aid dosage setting at a very low level.
- No special salt is being used despite the high degree of water hardness.
- Water softener system setting is at a very low level.
- Salt compartment cap not closed well.

If the dishes won't dry up

- A programme without a dry operation selected.
- Rinse aid dosage set too low
- Dishes unloaded too fast.

If there are rust stains on the dishes

- Stainless-steel quality of the dishes washed is insufficient.
- High rate of salt in the wash water.
- Salt compartment cap not closed well.
- Too much salt spilt into the sides and into the machine while filling it with salt.
- Unhealthy mains grounding.

Call for authorised service if the problem still persists after taking the above measures or in case of any malfunction not described above.

PRACTICAL AND USEFUL INFORMATION

1- When you won't be using your machine for an extended period

- Unplug the machine and then turn the water off.
- Leave the door slightly ajar in order to prevent the formation of unpleasant smells.
- Keep the machine interior clean.

2- Eliminating water droplets

- Wash the dishes with the intensive programme.
- Take all of the metal containers in the machine out.
- Do not add detergent.

3- If you properly place your dishes into the machine, you will be using it in the best way in terms of energy consumption, washing and drying performance.

4- Clean all rough waste before you place dirty dishes to the machine.

5- Operate the machine after it is completely full.

6- Use pre-washing program only when necessary.

7- Observe program information and average consumption values table when selecting a program.

8- Since the machine will reach high temperatures, it should not be placed near a refrigerator.

9- If the appliance is located in a place where the risk of freezing exists, you must completely drain the water that has remained in the machine. Turn off the water tap, disconnect the water inlet hose from the tap and allow the interior water to drain.

The dishwasher contains biocidal product in the PP sump filter to prevent bacterial growth.

Active Substance: zinc pyrithione (CAS No: 13463-41-7)

DISPOSAL OF YOUR OLD MACHINE

This symbol on the product or package implies that the product should not be treated as domestic waste. Instead, it should be delivered to waste collection places recycling electrical and electronic equipment. You will help avoid damage to the environment and risks to public health. Recycling materials will help natural resources to be preserved. For more detailed information regarding recycling of this product, please contact your local authority or the shop where you purchased the product from.





Service & Support

Visit Our Website
sharphomeappliances.com

SHARP

Be Original.

52253414 R35