



## Dishwasher

EN User Manual



Built-in Dishwasher

QW-S12I492X-EN



# CONTENTS

<b>CHAPTER-1: EXPLANATION OF PRODUCT</b>	
Technical specifications .....	5
Conformity with the standards and test data .....	5
<b>CHAPTER-2: SAFETY INFORMATION AND RECOMMENDATIONS</b>	
Recycling .....	6
Safety information .....	6
Recommendations .....	8
Items not suitable for dishwashing .....	8
<b>CHAPTER-3: INSTALLING THE MACHINE</b>	
Positioning the machine .....	8
Water connections .....	9
Water inlet hose .....	9
Water outlet hose .....	9
Electrical connection .....	10
Prior to using the machine .....	11
<b>CHAPTER-4: PREPARING THE MACHINE FOR USE</b>	
The importance of water decalcification .....	11
Filling with salt .....	11
Testing strip .....	11
Adjusting salt consumption .....	12
Detergent usage .....	12
Filling the detergent compartment .....	12
Combined detergent .....	13
Filling with rinse aid and making the setting .....	13
<b>CHAPTER-5: LOADING YOUR DISHWASHER</b>	
Dish rack .....	14
Alternative basket loads .....	16
<b>CHAPTER -6: PROGRAMME DESCRIPTIONS</b>	
Programme items .....	18
<b>CHAPTER -7: SWITCHING ON THE MACHINE AND SELECTING A PROGRAMME</b>	
Switching on the machine .....	19
Programme follow-up .....	19
Changing a programme .....	19
Changing a programme with resetting .....	20
Switching the machine off .....	20
<b>CHAPTER-8: MAINTENANCE AND CLEANING</b>	
Filters .....	21
Spray arms .....	21
Hose filter .....	21
<b>CHAPTER-9: FAILURE CODES AND WHAT TO DO IN CASE OF FAILURE</b>	22
<b>CHAPTER-10: PRACTICAL AND USEFUL INFORMATION</b>	23

Dear Customer, our goal is to offer you, high quality products that exceed your expectations. Your appliance is produced in modern facilities and is carefully tested for quality.

Before using your appliance, carefully read this guide which includes basic information for safe installation, maintenance and use.

The operating instructions apply to several models. Differences may therefore occur.

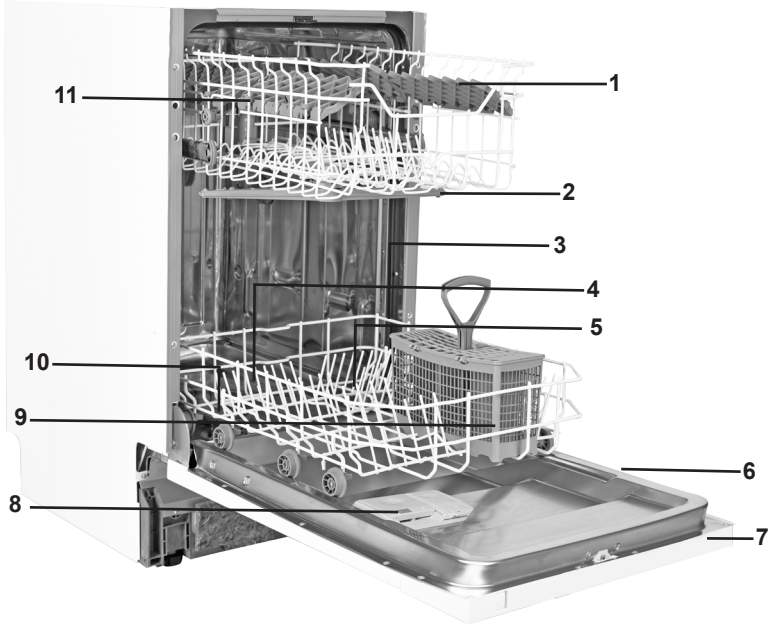

- 1. Upper basket with racks
- 2. Upper spray arm
- 3. Lower basket
- 4. Lower spray arm
- 5. Filters
- 6. Rating plate

- 7. Control Panel
- 8. Detergent and rinse-aid dispenser
- 9. Salt dispenser
- 10. Upper basket track latch
- 11. Upper Cutlery Basket



**Active Drying Unit:** This system provides better drying performance for your dishes.

## CHAPTER -1: TECHNICAL SPECIFICATIONS

### Technical specifications

Capacity	10 place settings
Height	820 mm - 870 mm
Width	450 mm
Depth	550 mm
Net Weight	32 kg
Electricity input	220-240 V, 50 Hz
Total Power	1900 W
Heating Power	1800 W
Pump Power	100 W
Drain Pump Power	30 W
Water supply pressure	0.03 MPa (0,3 bar)-1 MPa (10 bar)
Current	10 A

### Conformity with the standards and Test data / EU Declaration of Conformity

This product meets the requirements of all applicable EU directives with the corresponding harmonised standards, which provide for CE marking.

Please visit [www.sharphomeappliances.com](http://www.sharphomeappliances.com) for an electronic copy of this user manual.

### Recycling

- The recyclable materials are used in certain components and packaging.
- Plastic parts are marked with international abbreviations: (>PE< , >PS< , >POM< , >PP< , )
- Cardboard parts have been produced from recycled paper which should be disposed of into waste paper collection containers for recycling.
- Such materials are not suitable for garbage bins. They should be delivered to recycling centres instead.
- Contact relevant centres in order to obtain information on methods and points of disposal.

### Safety Information

#### When you take delivery of your machine

- If you see any damage on your machine's packaging, please notify your retailer.
- Unwrap the packaging materials as indicated and dispose of them in accordance with the rules.

#### The points to pay attention during machine installation

- Choose a suitable, safe and level place to install your machine.
- Carry out the installation and connection of your machine by following the instructions.
- We recommend that the machine is installed by an authorised installer, and should only be serviced by an approved technician.
- Only original spare parts should be used with the machine.
- Before installing, be sure that the machine is unplugged.
- Check whether the indoor electrical fuse system is connected according to the regulations.
- All electrical connections must match values on the rating plate.
- Be sure that the machine does not stand on the electricity supply cable.
- Never use an extension cord or a multiple socket for making a connection. The plug should be easily accessible after installation.
- After installation, run it unloaded for the first time.

#### In daily use

- This machine is for household use; do not use it for any other purpose. Commercial usage of the dishwasher will void the guarantee.
- Do not use detergents and rinse aids that are not specifically designed for dishwashers. Improper of such items may invalidate the warranty.
- Due to risk of explosion, do not put into the machine's washing section any chemical dissolving agents such as solvents.
- Check whether plastic items are heat-resistant before washing.

## CHAPTER -2: SAFETY INFORMATION AND RECOMMENDATIONS

• This appliance can be used by children aged from 8 years and above and persons with reduced physical, sensory or mental capabilities or lack of experience and knowledge if they are supervised or have been given instruction concerning use of the appliance in a safe way and understand the hazards involved. Children should not play with the appliance. Cleaning and user maintenance should not be made by children without supervision.

- Do not put unsuitable and heavy items above the basket capacity into your machine. SHARP will not be responsible for any damage on the inner parts.
- The door should not be opened whilst the machine is operating. A safety device will ensure that the machine stops if opened.
- To avoid accidents, do not leave the door open.
- Place knives and other sharp-ended objects in the cutlery basket in bladedown position.
- If the supply cord is damaged, it must be replaced by SHARP, or its service agent.
- If EnergySave option is selected as “Yes”, the door will be opened at the end of the program. Do not force the door closed to avoid harming the auto door mechanism for 1 minute. The door must be open for 30 minutes to dry effectively( in models with auto door opening system ).

**Warning:** Do not stand in front of the door after the auto-open signal sounds.

### **For your children's safety**

- After removing the machine's packaging, make sure that the packaging material is out of reach of children.
- Do not allow children to play with or start the machine.
- Keep children away from detergents and rinse aid.
- Keep children away from the machine while it is open because there may still be residues of cleaning substances inside the machine.
- Be sure that your old machine does not pose any threat to your children. Children are known to have become locked in old machines. To prevent such a situation, break your machine's door lock and tear off the electrical cables.

### **In case of malfunction**

- Any repair performed by anyone other than authorized service personnel will invalidate your warranty.
- Prior to any repair work on the machine, be sure that the machine is isolated from the mains. Switch off the fuse or unplug the machine. Do not pull by the cable when unplugging. Make sure to turn off the water tap.

### Recommendations

- For energy and water saving, remove coarse residues on your dishes before placing the dishes into the machine. Start your machine after having fully loaded it.
- Use the pre-wash programme only when necessary.
- Place hollow items such as bowls, glasses and pots into the machine in such a way that they will face down.
- You are not recommended to overload your machine or load it in a way other than that which is indicated.

### Items not suitable for dishwashing:

- Cigarette ash candle leftovers, polish, paint, chemical substances, ironalloy materials.
- Forks, spoons and knives with wooden or bone, or ivory or nacre-coated handles; glued items, items soiled with abrasive, acidic or base chemicals.
- Plastic items that are not heat-resistant, copper or tin-coated containers.
- Aluminium and silver objects (they may discolour, become dull).
- Certain delicate glass types, porcelain with ornamental printed patterns as they fade even after the first wash; certain crystal items as they lose their transparency over time, cutlery that is not heat-resistant, lead crystal glasses, cutting boards, items manufactured with synthetic fibre.
- Absorbent items as sponges or kitchen rags are not suitable for dishwashing.

**Warning:** Take care to buy dishwasher-proof sets in your future purchases.

### INSTALLING THE MACHINE

#### Positioning the machine

When determining the installation place, choose an accessible place for easy loading and unloading of the dishes.

Do not put your machine in any location where there is the possibility of the room temperature falling below 0°C.

Before positioning, take the machine out of its packaging by following the warnings located on the package.

Position the machine close to a water tap or drain. You need to site your machine, taking into consideration that its connections cannot be altered once they are made.

Do not grip the machine by its door or panel in order to move it.

Take care to leave sufficient clearance from all sides of the machine for moving it back and forth during cleaning.

Make sure that the water inlet and outlet hoses do not get squeezed while positioning the machine. Also, make sure that the machine does not stand on the electrical cable.

Adjust the machine's adjustable feet so that it can stand level and balanced. Proper positioning of the machine ensures problem-free opening and closing of the door.



## CHAPTER -3: INSTALLING THE MACHINE

If the door of machine does not close properly, check if the machine is stable on the floor if not, adjust the feet and ensure its stable position.

### Water connection

Indoor plumbing must be suitable for installing a dishwasher. Also, we recommend that you fit a filter at the entrance of your property so as to avoid any damage to your machine because of contamination (sand, clay, rust etc.) that might be occasionally carried in through the mains water supply or the indoor plumbing, and to prevent such complaints as yellowing and formation of deposits after washing.

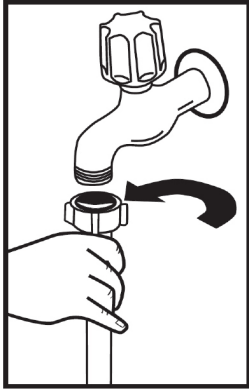

### Water inlet hose

Do not use the water inlet hose of your old machine. Use the new one supplied with your machine instead. If you connect a new or long - unused water inlet hose to your machine ,run water through it for a while before making the connection. Connect the water inlet hose directly to the water inlet tap. The pressure supplied by the tap should be at a minimum of 0.03 Mpa and and at a maximum of 1 Mpa.If the water pressure is above 1 Mpa,a pressure-relief valve should be fitted inbetween.

After making connections, the tap should be turned on fully and checked for water tightness. For safety purposes, we recommend that you turn off the water inlet tap when the machine is not going to be used for an extended period of time.

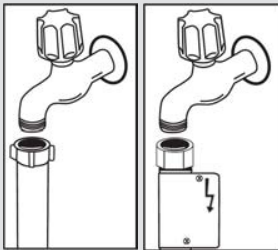

**NOTE:** An Aquastop water etc. spout is used in some models. With Aquastop, a potentially dangerous tension exists.Do not cut the Aquastop water spout. Do not let it get folded or twisted.

### Water outlet hose

The water drain hose can be connected either directly to the water drain hole or to the sink outlet spigot. Using a special bent pipe (if available), the water can be drained directly into the sink via hooking the bent pipe over the edge of the sink. This connection should be between 50 and 110 cm from the floor plane.

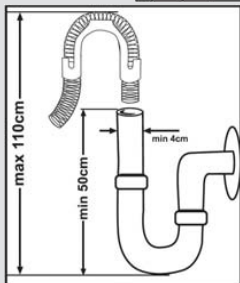

**Warning:** When a drain hose longer than 4 m is used, the dishes might remain dirty. In that case, SHARP will not accept responsibility.

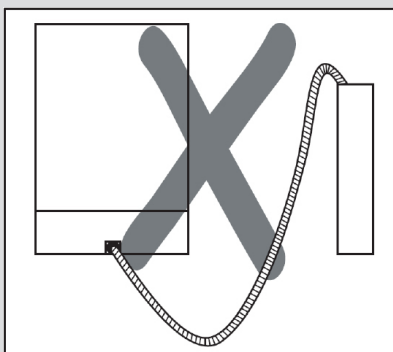
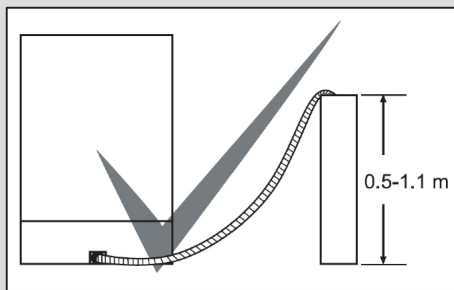

### Electrical connection

The earthed plug of your machine should be connected to an earthed outlet supplied by suitable voltage and current. If there is no earthing installation, have a competent electrician to carry it out. In case of usage without earthing installed, our company will not be responsible for any loss of usage that might occur. The indoor fuse current value should be 10-16 A. Your machine is set according to 220-240 V. If the mains voltage in your location is 110 V, connect a transformer of 110/220 V and 3000 W inbetween. The machine should not be plugged in during positioning. Always use the coated plug supplied with your machine. Running in low voltage will cause a decline in washing quality.

The machine's electrical cable should be replaced by an authorised service or an authorised electrician only. Failure to do so may lead to accidents. For safety purposes, we recommend that you disconnect the plug when the machine is not going to be used for an extended period of time. In order avoid electric shocks, do not unplug when your hands are wet. When disconnecting your machine from the mains supply, always pull from the plug. Never pull the cord itself.

## CHAPTER -4: PREPARING THE MACHINE FOR USE

### Prior to using the machine for the first time

- Check whether the electricity and supply water specifications match the values indicated by the installation instructions for the machine.
- Remove all packaging materials inside the machine.
- Set the water softener.
- Add 1 kg salt into the salt compartment and fill with water up to a level at which it will almost overflow.
- Fill the rinse aid compartment.

### PREPARING THE MACHINE FOR USE

#### The importance of water decalcification

For a good washing function, the dishwasher needs soft, i.e. less calcareous water. Otherwise, white lime residues will remain on the dishes and the interior equipment. This will negatively affect your machine's washing, drying and shining performance. For this reason, a softener system used on dishwashers. The softener system has to be refreshed so that it operates with the same performance also during the next wash. For this purpose, dishwasher salt is used.













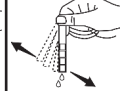









#### Filling with salt (IF AVAILABLE)

Use softener salt specifically produced for use in dishwashers. To add softener salt, first remove the lower basket and then open the salt compartment cap by turning it counter clockwise. (1) (2) At first use fill the compartment with 1kg salt and water (3) at overflowing level if available. Using a funnel (4) will make filling easier. Refill the cap and close it. After every 20th-30th wash, add salt into your machine until it fills up (approx. 1 kg) Fill the salt compartment with water at first use only. We recommend to use smallgrained or powder softener salt. Do not put table salt into your machine. Otherwise, the function of the softener compartment may decrease over time. When you start machine, the salt compartment gets filled with water. There fore, put the softener salt prior to starting your machine. This way, overflowing salt gets immediately cleaned up through the wash operation. If you will not wash any dishes immediately after putting salt, then run a short washing program with an empty machine in order to avoid corrosion on your machine due to the salt overflow while filling in the salt container. In order to understand whether or not the amount of

softener salt in machine is sufficient, check the transparent section on the salt compartment cap. There is sufficient salt if the transparent section is green. Salt has to be added if it is not green.

#### Testing strip

The washing effectiveness of your machine depends on the softness of the tap water. For this reason, your machine is equipped with a system that reduces the hardness in mains water supply. The washing effectiveness will increase when the system is correctly set. To find out the water hardness level of water in your area, contact your local water board or determine water hardness level by using the test strip(if available).

Open the testing strip	Run water through your tap for 1 min.	Keep the testing strip in water for 1.sec.	Shake the testing strip after taking it out of water	Water for 1 min.	Make your machine's water hardness setting according to the result obtained through the testing strip.																		
					<table border="1"> <tr> <td>Level 1</td> <td></td> <td>No Lime</td> </tr> <tr> <td>Level 2</td> <td></td> <td>Very low lime content</td> </tr> <tr> <td>Level 3</td> <td></td> <td>Low lime content</td> </tr> <tr> <td>Level 4</td> <td></td> <td>Medium lime content</td> </tr> <tr> <td>Level 5</td> <td></td> <td>Lime content</td> </tr> <tr> <td>Level 6</td> <td></td> <td>High lime content</td> </tr> </table>	Level 1		No Lime	Level 2		Very low lime content	Level 3		Low lime content	Level 4		Medium lime content	Level 5		Lime content	Level 6		High lime content
Level 1		No Lime																					
Level 2		Very low lime content																					
Level 3		Low lime content																					
Level 4		Medium lime content																					
Level 5		Lime content																					
Level 6		High lime content																					

## CHAPTER -4: PREPARING THE MACHINE FOR USE

### Adjusting salt consumption

Water hardness level	German hardness level dH	French hardness level dF	British hardness level dE	Hardness Level Indicator
1	0-5	0-9	0-6	L1 is seen on display.
2	6-11	10-20	7-14	L2 is seen on display.
3	12-17	21-30	15-21	L3 is seen on display.
4	18-22	31-40	22-28	L4 is seen on display.
5	23-34	41-60	29-42	L5 is seen on display.
6	35-50	61-90	43-63	L6 is seen on display.

Adjust the water softener according to how hard your tap water.



After resetting your machine, press the program selection button and keep it pressed down (3).

Meanwhile, energise the machine by pressing the Power On/Off button (1).

Keep the program selection button pressed until the leds "P1-P2-P3" are on and off (3)

After the leds " P1-P2-P3." have flashed (2) , release the program selector button (3).

Your machine displays the latest entered water hardness setting.

You can adjust the levels by program selector button (3) according to Table of Water Hardness Level Settings.

After adjusting the water hardness level , press on/off button to save the settings in memory (3).

### Detergent usage

Use a detergent specifically designed for use in domestic dishwashers.

You can find powder, gel, and tablet detergents that have been designed for household dishwashers.

Detergent should be put into the compartment prior to starting the machine. Keep your detergents in cool, dry places out of reach of your children.

Do not overfill the detergent compartment; otherwise it may cause scratches on your glasses as well as lead to a poorly dissolved detergent.

Should you need more information concerning the detergent you will use, contact the detergent manufacturers directly.

### Filling the detergent compartment

Push the latch to open the detergent container as shown in the image. 1 The Detergent pod has level lines inside. The Detergent pod can take a total of 40 cm<sup>3</sup> of detergent. Open the dishwasher detergent and pour into the larger compartment **b** 25 cm<sup>3</sup> if dishes are heavily soiled or less 15 cm<sup>3</sup>. 2 If dishes have been kept dirty for a very long time with, dried food waste on them or the dishwasher has been overloaded pour **a** 5cm<sup>3</sup> of detergent into the prewash compartment and start the machine. You may have to add more detergent into your machine, depending on the degree of soil and on the water hardness level in your area.

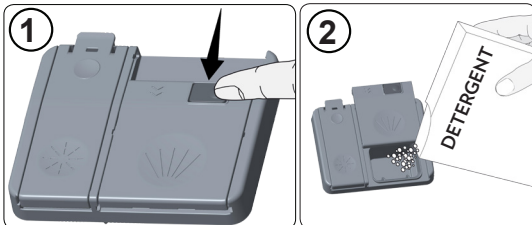

## CHAPTER -4: PREPARING THE MACHINE FOR USE

### Combined detergents

Combined detergents may include various properties. Before using the detergent, read the instructions carefully. Generally combined detergents produce sufficient results under certain conditions only.

### Points to consider when using this type of products:

- Check the specifications of the product whether it is combined or not.
- Check if the detergent used is appropriate for the hardness of mains water.
- Observe the instructions of products on the packaging.
- Always put the tablets into the detergent compartment in the detergent dispenser.
- You need to contact the manufacturers and find out about the suitable conditions of use.
- If you use appropriate products, they ensure savings in salt and/or rinse aid consumption.
- The scope of warranty for your machine does not cover any complaints caused by the use of these types of detergents.

**Recommended usage:** If you want to obtain better results while using combined detergents, add salt and rinse aid into your machine and adjust the water hardness setting and the rinse aid setting to the lowest position.



Solubility of the tablet detergents produced by different companies can vary depending on the temperature and time. Therefore, it is not recommended to use such detergents in short programs. It is more suitable to use powder detergents.

**Warning:** Should any problem, which you have not encountered before arise with the use of this type of detergent, contact the detergent manufacturer directly.

### When you stop using combined detergents

- Fill the salt and rinse aid compartments.
- Adjust the water hardness setting to the highest position and run an empty-wash.
- Adjust the water hardness level.
- Make the suitable rinse aid setting.

### Filling with rinse aid and making the setting

To fill the rinse aid compartment, open the rinse-aid compartment cap. Fill the compartment with rinse aid until the MAX level and then close the cap. Be careful not to overfill the rinse aid compartment and wipe up any spills.

**In order to change the rinse aid level, follow the below steps before turning on the machine:**

- Push the programme button and hold it down.
- Turn on the machine.
- Hold down the programme button until all leds blink twice. Rinse aid setting follows water hardness setting.
- The machine will display the current setting.
- Change the level by pushing the programme button.
- Switch off the machine to save the setting.

The factory setting is "4".

If the dishes are not drying properly or are spotted, increase the level. If blue stains form on your dishes, decrease the level.

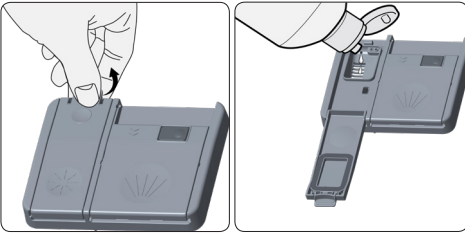

Level	Brightener Dose	Indicator
1	Rinse-aid not dispensed	P1 LED is on
2	1 dose is dispensed	P2 LED is on
3	2 doses are dispensed	P3 LED is on
4	3 doses are dispensed	P1-P3 LEDs are on
5	4 doses are dispensed	P2-P3 LEDs are on

## CHAPTER-5: LOADING YOUR DISHWASHER

### LOADING YOUR DISHWASHER

Place dishes properly into the machine.

There are two separate baskets to load dishes into your machine. The lower basket is for round and deep items. The upper basket is for thin and narrow items. You are recommended to use the cutlery basket in order to obtain the best result.

To avoid any possible injuries, place long-handle and sharp-pointed knives with their sharp points facing down or horizontally on the baskets.

**Warning:** Place your dishes into your machine in a way that they will not prevent the upper and lower spray arms from spinning.

### Dish rack

There are dish racks on the upper basket of your machine.

**a b** You can use these dish racks in open or closed position. When they are in open position **a** you can place your cups on them; and when in closed position **b** you can place long glasses on the basket. Also, you can use these racks by placing long forks, knives and spoons on them laterally.

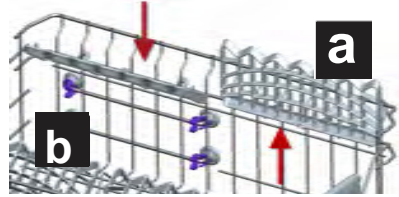

### Folding Racks

Foldable racks on the upper basket are designed in order to let you place big items easier such as pots, pans, etc. If requested, each part can be folded separately, or all of them can be folded and larger spaces can be obtained. You can use foldable racks by raise them upwards, or by folding down.

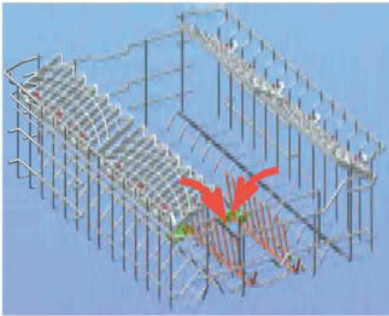

### Top basket height adjustment

Top basket of your machine is in upper position. When it is in this position, you can place big items such as pans, etc. on lower basket. When you take top basket to lower position, you can place and wash big sized plates on the top basket. Use wheels in order to change the basket height. Open the basket retaining parts at the end of top basket rails by turning them to the sides, and take the basket out. Change the position of the wheels; re-install the basket to the rail, and close basket retainer parts. In this way, you take the top basket to lower position.

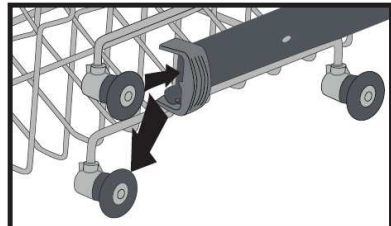
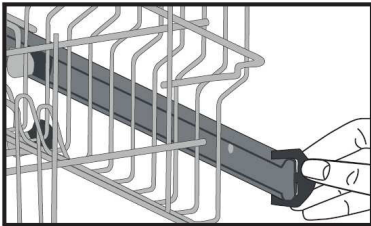

## CHAPTER-5: LOADING YOUR DISHWASHER

### Lower Basket

#### Folding Racks

Folding racks consisting of two parts that are located on the lower basket of your machine are designed in order to let you place big items easier such as pots, pans, etc. If requested, each part can be folded separately, or all of them can be folded and larger spaces can be obtained. You can use folding racks by raising them upwards, or by folding them down.



## CHAPTER-5: LOADING YOUR DISHWASHER

### Alternative basket loads Lower Basket



### Top basket

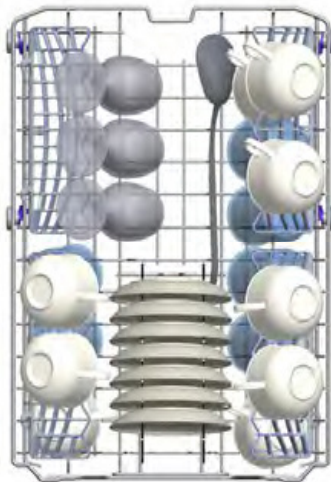



## CHAPTER-5: LOADING YOUR DISHWASHER

### Faulty loads

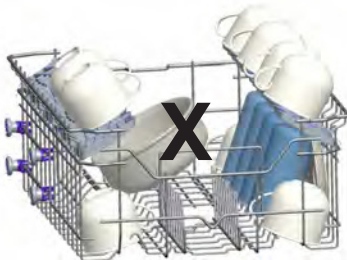
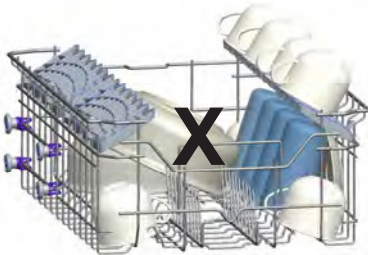
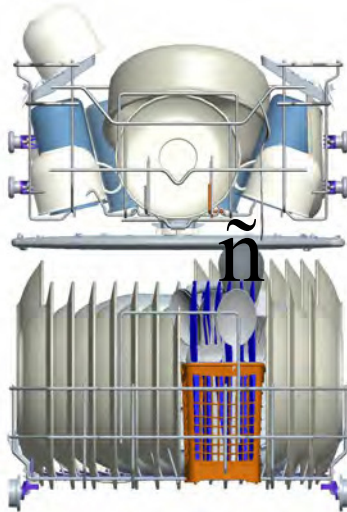

### Important Note for Test Laboratories

For detailed information on performance tests, please contact following address: "dishwasher@standardtest.info". In your email, please provide the model name and serial number (20 digits) which you can find on the appliance door.

## CHAPTER -6: PROGRAMME DESCRIPTIONS

### PROGRAMME DESCRIPTIONS

#### Programme items

Programme No.		Reference	
Programme names and temperatures	Intensive (P1) 65°C	Eco (P2)	Prewash (P3) No Heat
Type of food waste	soups, sauces, pasta, eggs, pilaf, potato and oven dishes, fried foods	coffee, milk, tea, cold meats, vegetables, not kept for long	Pre-wash to rinse and loosen residue-awaiting full load-then select a programme
Level of soil	high	medium	-
Detergent amount B: 25 cm <sup>3</sup> / 15 cm <sup>3</sup> A: 5 cm <sup>3</sup>	A+B	A+B	-
	Prewash	Prewash	Prewash
	65°C wash	50°C wash	End
	Cold rinse	Cold rinse	
	Hot rinse	Hot rinse	
	Dry	Dry	
	End	End	
Programme duration (min.)	115	198	15
Electricity consumption (kW hours)	1,33	0,73	0,02
Water consumption (litres)	17,6	11,0	3,5

**Warning:** Short programs do not include a drying step.

The values declared above are the values obtained under laboratory conditions according to relevant standards. These values can change depending on conditions of product's use and environment (network tension, water pressure, water input temperature and environment temperature).

# CHAPTER -7: SWITCHING ON THE MACHINE AND SELECTING A PROGRAMME

## Switching on the machine

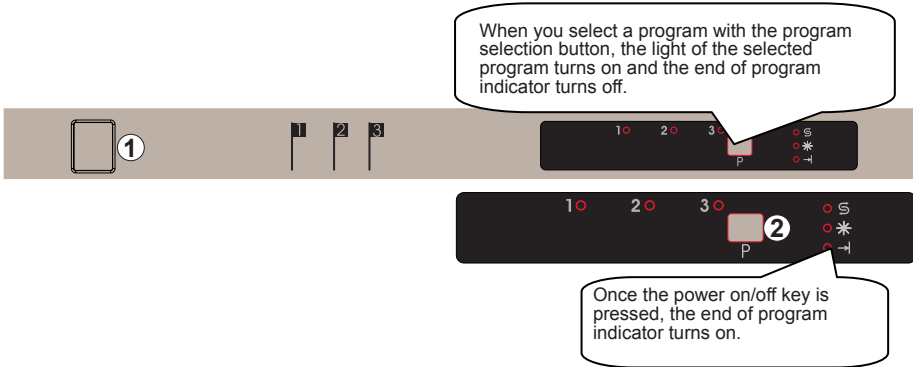

1. Press the Power On/Off key.
2. Select the programme suiting your dishes via the Programme Selection button.
3. Close the door. The programme starts automatically.

**Please note:** If you decide not to start machine after selecting the programme, just press the on/off button. Your machine will become ready for the new programme selection when you press on/off button again. You can select the new programme by pressing the programme selection button.

### Programme follow-up

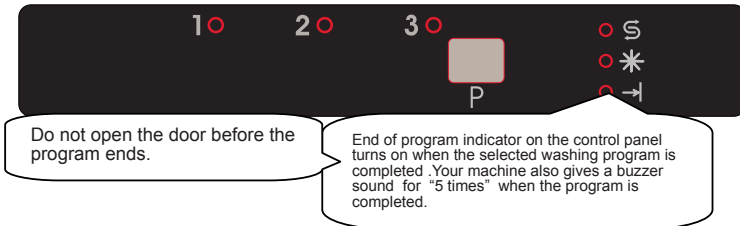

### Changing a programme

If you would like to change programmes while a washing programme is running.

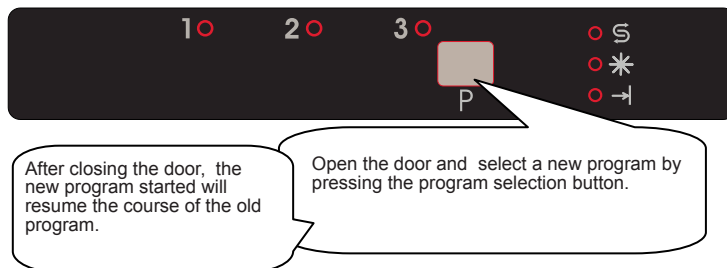

**Please note:** When the door of the machine is opened in order to stop the washing programme before it is completed, first open the door slightly to avoid water spillage.

## CHAPTER -7: SWITCHING ON THE MACHINE AND SELECTING A PROGRAMME

### Changing a programme with resetting

If you would like to cancel a programme while a washing programme is resumed.

Open the door of your machine. Light of the last selected program will turn on.



Keep the program selection button pressed for 3 seconds. (End of program indicator flashes and program light turns off)

Discharge process starts after closing the door of the machine. The machine discharges the water in it for about 30 seconds. When the program is cancelled, your machine gives a buzzer sound for "5 times" and the "end of program indicator" turns on.

**Please note:** When the door of the machine is opened in order to stop the washing program before it is completed, first open the door slightly to avoid water spillage.

### Switching the machine off

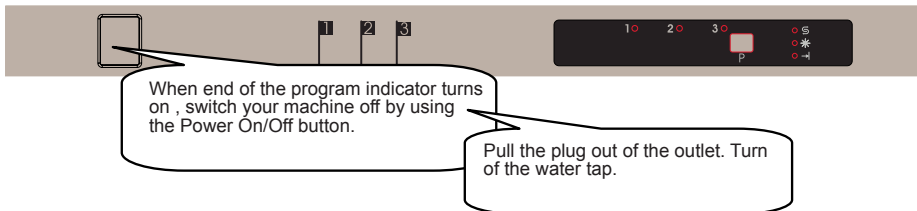

**Please note:** After the buzzer sound which indicates the end of the programme when the washing programme comes to an end (end indicator light is on), you can leave the door of your machine ajar to speed up the drying.

**Please note:** If the machine door opens during washing or the power is cut off, the machine will go back to the programme once the door is shut or the power is back.

**Please note:** If the power supply is cut or the machine door is opened during the drying process, the programme is terminated. Your machine becomes ready for a new programme selection.

## CHAPTER -8: MAINTENANCE AND CLEANING

**Cleaning the machine regularly prolongs the machine's service life.**

**Oil and limescale may accumulate in the machine's washing section. In case of such accumulation;**

-Fill the detergent compartment without loading any dishes into the machine, run the machine at high temperature. If this does not work, use special cleansing materials.

**Cleaning the seals in the machine door,**

-Wipe the seals regularly by using a dampened cloth.

**Cleaning machine,**

Clean the filters and spray arms at least once a week.

Unplug your machine and turn off its tap before starting the cleaning.

Wipe with a fine cleaning material and a dampened cloth.

**Filters**

If any food wastes have remained on the coarse and fine filters, remove the filters and clean them thoroughly under the water tap.

**a. Micro Filter**

**b. Coarse Filter**

**c. Metal/Plastic Filter**

To remove and clean the filter combination, turn it counter clockwise and take it out by lifting upwards. **1**

Pull and remove the metal/plastic filter. **3** Then pull the coarse filter out of the micro filter. **2** Rinse it with lots of water under the tap. Refit the metal/plastic filter. Insert the coarse filter into the micro filter in a way that the marks will correspond to one another. Attach micro filter into the metal/plastic filter and turn to the direction of arrow and it is locked when the arrow on micro filter can be seen from across. **4**

- Never use your dishwasher without a filter.
- Incorrect fitting of the filter will reduce the washing effectiveness.
- Clean filters are very important in terms of the proper running of the machine.

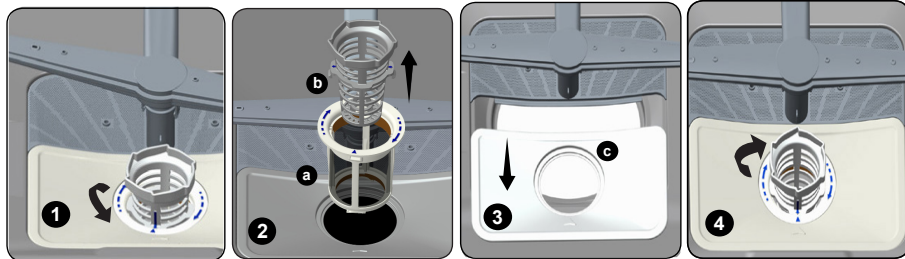

### Spray arms

Check the holes for the upper and lower spray arms. If there is any clogging, remove the spray arms and clean them under water.



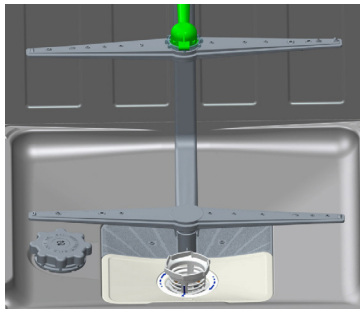











You can remove the lower spray arm by pulling it upwards, while the upper spray arm nut can be removed by turning the nut to the left. Be sure that the nut is perfectly tightened when refitting the upper spray arm.



### Hose filter

Check the filter and the hose from time to time and clean them to prevent yellowing and formation of deposits after washing. To clean the filter, first turn off your tap and then remove the hose. After removing the filter from the hose, clean it under the tap. Insert the cleaned filter back into its place inside the hose. Refit the hose.

## CHAPTER -9: FAILURE CODES AND WHAT TO DO IN CASE OF FAILURE

ERROR CODE				ERROR DESCRIPTION	CONTROL
P1	P2	P3	P4		
				Inadequate water supply	<ul style="list-style-type: none"> <li>• Make sure the water input tap is totally open and that there is no water cut.</li> <li>• Close the water input tap, separate the water input hose from the tap and clean the filter at the connection end of the hose.</li> <li>• Restart your machine, contact the service if the error resumes.</li> </ul>
				Error of continuous water input	<ul style="list-style-type: none"> <li>• Close the tap.</li> <li>• Contact service.</li> </ul>
				The waste water in the machine cannot be discharged.	<ul style="list-style-type: none"> <li>• Water discharge hose is clogged.</li> <li>• The filters of your machine might be clogged.</li> <li>• Power off-on your machine and activate the program cancellation command.</li> <li>• If the error continues, contact the service.</li> </ul>
				Heater error	<ul style="list-style-type: none"> <li>• Contact service.</li> </ul>
				Alarm is active against water overflow	<ul style="list-style-type: none"> <li>• Power off your machine and close the tap.</li> <li>• Contact service.</li> </ul>
				Faulty electronic card	<ul style="list-style-type: none"> <li>• Contact service.</li> </ul>

### If one of the program monitor lights is on and start/Pause light is on and off,

Your machine's door is open, shut the door.

### If the programme won't start

- Check if the plug is connected.
- Check your indoor fuses.
- Be sure that the water inlet tap is turned on.
- Be sure that you have closed the machine door.
- Be sure that you switched off the machine by pressing the Power On / Off button.
- Be sure that the water inlet filter and the machine filters are not clogged.

### If the lamps "Wash/Dry" and "End" keep flashing

- The water overflow alarm is active
- Turn off your tap and contact the Sharp helpdesk.

### If the control lamps won't go out after a wash operation

Check if the Power On/Off button is released.

### If detergent residues are left in the detergent compartment

Detergent has been added when the detergent compartment was wet.

### If water is left inside the machine at the end of the programme

- The water drain hose is clogged or twisted.
- The filters are clogged.
- The programme is not finished yet.

### If the machine stops during a wash operation

- Power failure.
- Water inlet failure.
- Program can be on standby mode.

### If shaking and hitting noises are heard during a wash operation

- Dishes placed incorrectly.
- Spray arm hitting the dishes.

## CHAPTER -10: PRACTICAL AND USEFUL INFORMATION

### **If there are partial food wastes left on the dishes**

- Dishes placed incorrectly into the machine, sprayed water did not reach related places.
- Basket overly loaded.
- Dishes leaning against one another.
- Small amount of detergent added.
- An unsuitable, rather weak wash programme selected.
- Spray arm clogged with food wastes.
- Filters clogged.
- Filters incorrectly fitted.
- Water drain pump clogged.

### **If there are whitish stains on the dishes**

- insufficient detergent is being used
- Rinse aid dosage setting at a very low level.
- No special salt is being used despite the high degree of water hardness.
- Water softener system setting is at a very low level.
- Salt compartment cap not closed well.

### **Won't dry no need for dry**

- A programme without a dry operation has been selected.
- Rinse aid dosage set too low
- Dishes unloaded too fast.

### **If there are rust stains on the dishes**

- Stainless-steel quality of the dishes washed is insufficient.
- High rate of salt in the wash water.
- Salt compartment cap not properly closed.
- Too much salt spilt into the sides and into the machine while filling it with salt.
- Poor mains grounding.

**Call an authorised service if the problem still persists after the controls or in case of any malfunction not described above.**

### **PRACTICAL AND USEFUL INFORMATION**

**1-** When you won't be using your machine for an extended period

- Unplug the machine and then turn the water off.
- Leave the door slightly ajar in order to prevent the formation of unpleasant smells.
- Keep the machine interior clean.

**2-** Eliminating water droplets

- Wash the dishes with the intensive programme.
- Take all of the metal containers in the machine out.
- Do not add detergent.

**3-** If you properly place your dishes into the machine, you will be using it in the best way in terms of energy consumption, washing and drying performance.

**4-** Clean all rough waste before you place dirty dishes to the machine.

**5-** Operate the machine after it is completely full.

**6-** Use pre-washing program only when necessary.

**7-** Observe program information and average consumption values table when selecting a program.

**8-** Since the machine will reach high temperatures, it should not be placed near a refrigerator.

**9-** If the appliance is located in a place where the risk of freezing exists, you must completely drain the water that has remained in the machine. Turn off the water tap, disconnect the water inlet hose from the tap and allow the interior water to drain.

The dishwasher contains biocidal product in the PP sump filter to prevent bacterial growth.  
Active Substance: zinc pyrithione (CAS No: 13463-41-7)

## DISPOSAL OF YOUR OLD MACHINE

This symbol on the product or package implies that the product should not be treated as domestic waste. Instead, it should be delivered to waste collection places recycling electrical and electronic equipment. You will help avoid damage to the environment and risks to public health. Recycling materials will help natural resources to be preserved. For more detailed information regarding recycling of this product, please contact your local authority or the shop where you purchased the product from.





Register your product here  
[WWW.SHARPHOMEAPPLIANCES.COM](http://WWW.SHARPHOMEAPPLIANCES.COM),  
by registering with Sharp you become part of  
our For Life promise to always be there for you  
and your appliance.



Service  
& Support

Visit our website:

[www.sharphomeappliances.com](http://www.sharphomeappliances.com)

Or contact us:



You Tube

%100 recycleable paper

52248035 R36