



Dishwashing

EN User Manual



Fullsize Dishwasher

QW-S24F443I-FR

CONTENTS

CHAPTER-1: EXPLANATION OF PRODUCT	
Technical specifications	5
Conformity with the standards and test data	5
CHAPTER-2: SAFETY INFORMATION AND RECOMMENDATIONS	
Recycling	6
Safety information	6
Recommendations	8
Items not suitable for dishwashing	8
CHAPTER-3: INSTALLING THE MACHINE	
Positioning the machine	8
Water connections	9
Water inlet hose	9
Water outlet hose	9
Electrical connection	10
Fitting the machine undercounter	11
Prior to using the machine	13
CHAPTER-4: PREPARING THE MACHINE FOR USE	
The importance of water decalcification	13
Filling with salt	13
Testing strip	13
Adjusting salt consumption	14
Detergent usage	14
Filling the detergent compartment	14
Combined detergent	15
Filling with rinse aid and making the setting	15
CHAPTER-5: LOADING YOUR DISHWASHER	
Dish rack	16
Alternative basket loads	19
CHAPTER -6: PROGRAMME DESCRIPTIONS	
Programme items	21
CHAPTER -7: SWITCHING ON THE MACHINE AND SELECTING A PROGRAMME	
Switching on the machine	25
Programme follow-up	25
Changing a programme	25
Changing a programme with resetting	26
Switching the machine off	26
CHAPTER-8: MAINTENANCE AND CLEANING	
Filters	27
Spray arms	27
Hose filter	27
CHAPTER-9: FAILURE CODES AND WHAT TO DO IN CASE OF FAILURE	28
CHAPTER-10: PRACTICAL AND USEFUL INFORMATION	29

Dear Customer, our goal is to offer you, high quality products that exceed your expectations. Your appliance is produced in modern facilities and is carefully tested for quality.

Before using your appliance, carefully read this guide which includes basic information for safe installation, maintenance and use.

The operating instructions apply to several models. Differences may therefore occur.

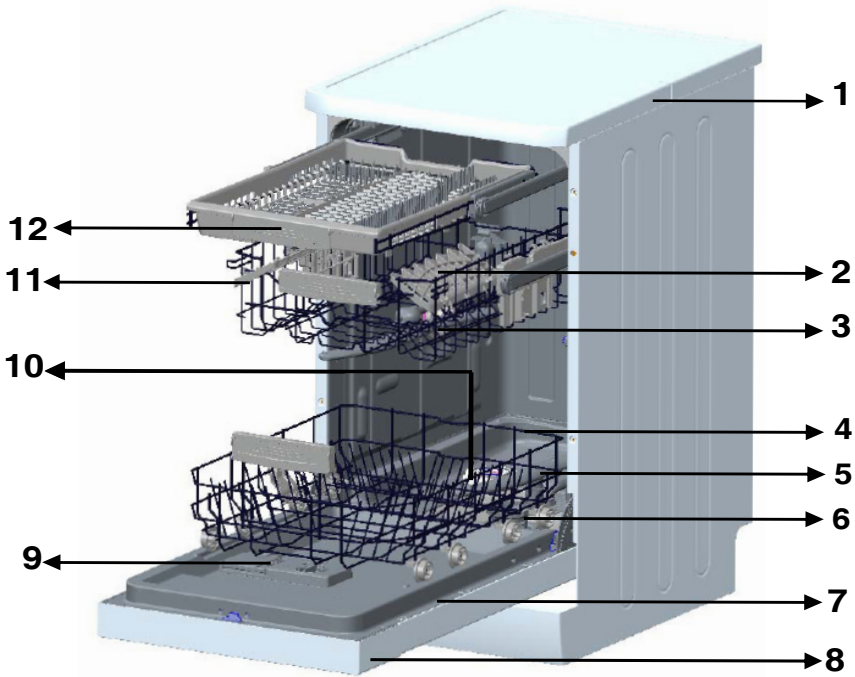

- 1. Worktop
- 2. Upper basket with racks
- 3. Upper spray arm
- 4. Lower basket
- 5. Lower spray arm
- 6. Filters

- 7. Rating plate
- 8. Control Panel
- 9. Detergent and rinse-aid dispenser
- 10. Salt dispenser
- 11. Upper basket track latch
- 12. Upper Cutlery Basket



Turbo Drying Unit:

This system provides better drying performance for your dishes.



Ceiling Spray Arm:

It provides better washing for the dishes at upper basket.

CHAPTER -1: TECHNICAL SPECIFICATIONS

Technical specifications

Capacity	10 place settings
Height	850 mm
Height (without worktop)	820 mm
Width	450 mm
Depth	598 mm
Net Weight	40 kg
Electricity input	220-240 V, 50 Hz
Total Power	1900 W
Heating Power	1800 W
Pump Power	100 W
Drain Pump Power	30 W
Water supply pressure	0.03 MPa (0,3 bar)-1 MPa (10 bar)
Current	10 A

Conformity with the standards and Test data / EU Declaration of Conformity

This product meets the requirements of all applicable EU directives with the corresponding harmonised standards, which provide for CE marking.

Please visit www.sharphomeappliances.com for an electronic copy of this user manual.

SAFETY INFORMATION AND RECOMMENDATIONS

Recycling

- The recyclable materials are used in certain components and packaging.
- Plastic parts are marked with international abbreviations: (>PE< , >PS< , >POM< , >PP< ,)
- Cardboard parts have been produced from recycled paper which should be disposed of into waste paper collection containers for recycling.
- Such materials are not suitable for garbage bins. They should be delivered to recycling centres instead.
- Contact relevant centres in order to obtain information on methods and points of disposal.

Safety Information

When you take delivery of your machine

- If you see any damage on your machine's packaging, please contact the authorised service.
- Unwrap the packaging materials as indicated and dispose of them in accordance with the rules in force.

Points to pay attention during machine installation

- Choose a suitable, safe and level place to install your machine.
- Carry out the installation and connection of your machine by following the instructions.
- This machine should only be installed and repaired by an authorised service technician.
- Only original spare parts should be used with the machine.
- Before installing, be sure that the machine is unplugged.
- Check whether the indoor electrical fuse system is connected according to the regulations.
- All electrical connections must match the values on the rating plate.
- Be sure that the machine does not stand on the electricity supply cable.
- Never use an extension cord or a multiple socket for making a connection. The plug should be comfortably accessible after installation.
- After installation, run it unloaded for the first time.

In daily use

- This machine is for household use; do not use it for any other purpose. Commercial usage of the dishwasher will void the warranty.
- Do not get up, sit or place a load when the door is open, it may fall over.
- Never use a detergent and rinse agent which is not produced specifically for dishwashers. Our company will not be liable for this.
- The water in the machine's washing section is not drinking water. Do not drink it.

CHAPTER -2: SAFETY INFORMATION AND RECOMMENDATIONS

- Due to danger of explosion, do not put any chemical dissolving agents such as solvents into the machine's washing section.
- Check whether plastic items are heat-resistant before washing.
- This appliance can be used by children aged 8 years and over and persons with reduced physical, sensory or mental capabilities or lack of experience and knowledge if they have been given supervision or instruction concerning use of the appliance in a safe way and understand the hazards involved. Children shall not play with the appliance. Cleaning and user maintenance should not be carried out by children without supervision.
- Do not put unsuitable and heavy items above the basket's capacity into your machine. Our company will not be liable for any damage on the internal parts.
- The door must not open while the machine is operating. In any case, the safety device ensures that the machine stops if the door is opened.
- Do not leave the door open, to avoid accidents.
- Place knives and other sharp-ended objects in the cutlery basket in blade-down position.
- If the supply cord is damaged, it must be replaced by the manufacturer, its service agent or competent technician in order to prevent a hazard.
- If the Energy Save option is selected as "Yes", The door will be opened at the end of the programme. Do not force the door shut to avoid harm to the auto door mechanism for 1 minute. The door must be open for 30 minutes for effective drying.(in models with an auto door opening system)

Warning: Do not stand in front of the door after the signal for the auto-open sounds.

For your children's safety

- After removing the machine's packaging, make sure that the packaging material is out of reach of children.
- Do not allow children to play with or start the machine.
- Keep children away from detergents and rinse agents.
- Keep children away from the machine while it is open as there may still be cleaning substance residues inside the machine.
- Be sure that your old machine does not pose any threat to your children. Children are known to have gotten themselves locked in old machines. To forestall such a situation, break your machine's door lock and tear off the electrical cables.

In case of malfunctioning

- Any repairs performed by anyone other than authorized service staff will result out of scope warranty to your machine.
- Prior to any repair work on the machine, be sure that the machine is cut off from the power supply. Switch off the fuse or unplug the machine. Do not pull by the cable when unplugging. Make sure to turn off the water tap.

Recommendations

- For energy and water saving, remove coarse residues on your dishes before placing the dishes into the machine. Start your machine after having fully loaded it.
- Use the pre-wash programme only whenever necessary.
- Place such hollow items as bowls, glasses and pots into the machine in such a way so they face down.
- You are recommended not to load into your machine any dishes different or more than indicated.

Items not suitable for dish washing:

- Cigarette ashes, candle wax, polish, paint, chemical substances, iron-alloy materials;
- Forks, spoons and knives with wooden, bone, ivory or nacre-coated handles; glued items, items soiled with abrasive, acidic or base chemicals.
- Plastic items that are not heat-resistant, copper or tin-coated containers.
- Aluminium and silver objects (they may discolour, become dull).
- Certain delicate glass types, porcelains with ornamental printed patterns as they fade even after the first wash; certain crystal items as they lose their transparency over time, adhered cutlery that is not heat-resistant, lead crystal glasses, cutting boards, items manufactured with synthetic fibres;
- Absorbent items such as sponges or kitchen rags are not suitable for dishwashing.

Warning: Make sure to purchase dishwasher-safe sets in your future purchases.

INSTALLING THE MACHINE

Positioning the machine

When determining the installation place, ensure an accessible place for easy loading and unloading of dishes.

Do not put your machine in any location where there is a probability of the room temperature falling below 0°C.

Before positioning, take the machine out of its packaging by following the warnings located on the packaging.

Position the machine close to a water tap or drain. You need to site your machine, taking into consideration that its connections cannot be altered once they are made.

Do not grip the machine by its door or panel in order to move it.

Take care to leave sufficient clearance from all sides of the machine to comfortably move it back and forth during cleaning. Make sure that the water inlet and outlet hoses do not get squeezed while positioning the machine.

Also, make sure that the machine does not stand on the electrical cable.

Adjust the machine's adjustable feet so that it can stand level and balanced.

The proper positioning of the machine ensures problem-free opening and closing of the door.

CHAPTER -3: INSTALLING THE MACHINE

If the door of the machine does not close properly, check if the machine is stable on the floor on which it stands; if not, adjust the feet and ensure its stable position.

Water connection

Indoor plumbing must be suitable for installing a dishwasher. We also recommend that you fit a filter at the entrance of your house or apartment so as to avoid any damage to your machine as a result of any contamination (sand, clay, rust etc.) that might be occasionally carried in through the main water supply or the indoor plumbing, and to forestall such complaints as yellowing and the formation of deposits after washing.

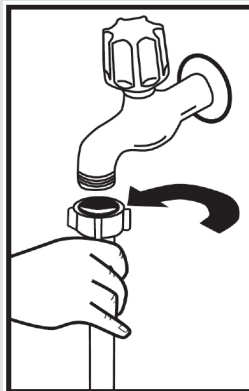

Water inlet hose

Do not use the water inlet hose of your old machine. Use the new hose supplied with your machine. If you connect a new or long - unused water inlet hose to your machine, run water through it for a while before making the connection. Connect the water inlet hose directly to the water inlet tap. The pressure supplied by the tap should be at a minimum of 0.03 Mpa and at a maximum of 1 Mpa. If the water pressure is above 1 Mpa, a pressure-relief valve should be fitted in between.

After making connections, the tap should be turned on fully and checked for water tightness. For the safety of machine, turn off the water inlet tap after finishing each wash programme.

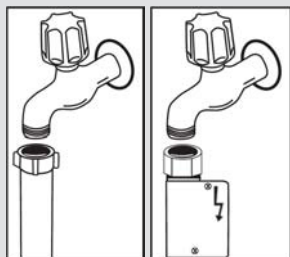

NOTE: An aquastop water spout is used in some models. In the event of using Aquastop, a dangerous tension exists. Do not cut Aquastop water spout. Do not let it get folded or twisted.

Water outlet hose

The water drain hose can be connected either directly to the water drain hole or to the sink outlet spigot. Using a special bent pipe (if available), the water can be drained directly into the sink via hooking the bent pipe over the edge of the sink. This connection should be between 50 and 110 cm from the floor plane.

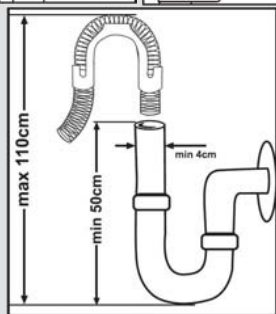

CHAPTER -3: INSTALLING THE MACHINE

Warning: When a drain hose longer than 4 m is used, the dishes may remain dirty. In such a case, our company will not accept liability.

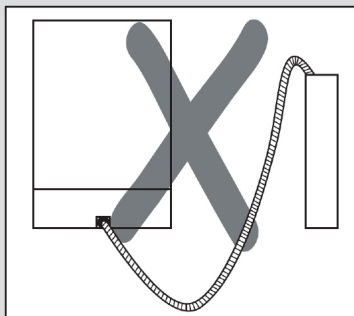
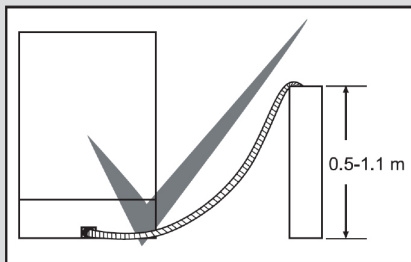

Electrical connection

The grounded plug of your machine should be connected to an grounded outlet supplied by a suitable voltage and current. If there is no grounding installation, have a competent electrician carry one out. In the event of usage without installed grounding, our company will not be liable for any loss of usage that may occur.

The indoor fuse current value should be 10-16 A.

Your machine is set to 220-240 V. If the power supply voltage in your location is 110 V, connect a transformer of 110/220 V and 3000 W in between. The machine should not be plugged in during positioning.

Always use the coated plug supplied with your machine.

Operation in low voltage will cause a decline in washing quality.

The machine's electrical cable should be replaced by an authorised service or an authorised electrician only. Failure to do so may lead to accidents.

For safety purposes, always make sure to disconnect the plug when a wash programme is finished.

In order to avoid an electric shock, do not unplug when your hands are wet. When disconnecting your machine from the main supply, always remove by the plug. Never pull on the cord itself.

Fitting the machine undercounter

If you wish to fit your machine undercounter, check whether you have sufficient space under your countertop and whether the wiring-plumbing is suitable to do so. **1** If you decide that the space under the countertop is suitable for fitting your machine, remove the worktop as shown in the illustration. **2**

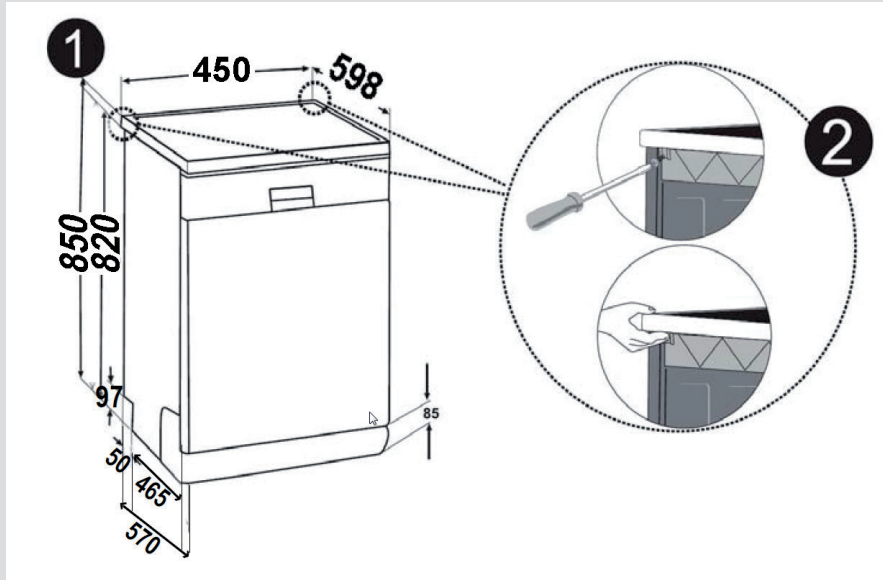

Warning: The surface which you place the machine under when removing its worktop has to be stable to avoid balance problems.

To remove the worktop, remove the screws that hold the worktop which are located at the rear of the machine; then push the front panel 1 cm from the front side towards the rear and lift it.

CHAPTER -3: INSTALLING THE MACHINE

Adjust the machine's feet according to the slope of the floor. **3** Fit your machine by pushing it undercounter without letting the hoses get crushed or bent. **4**

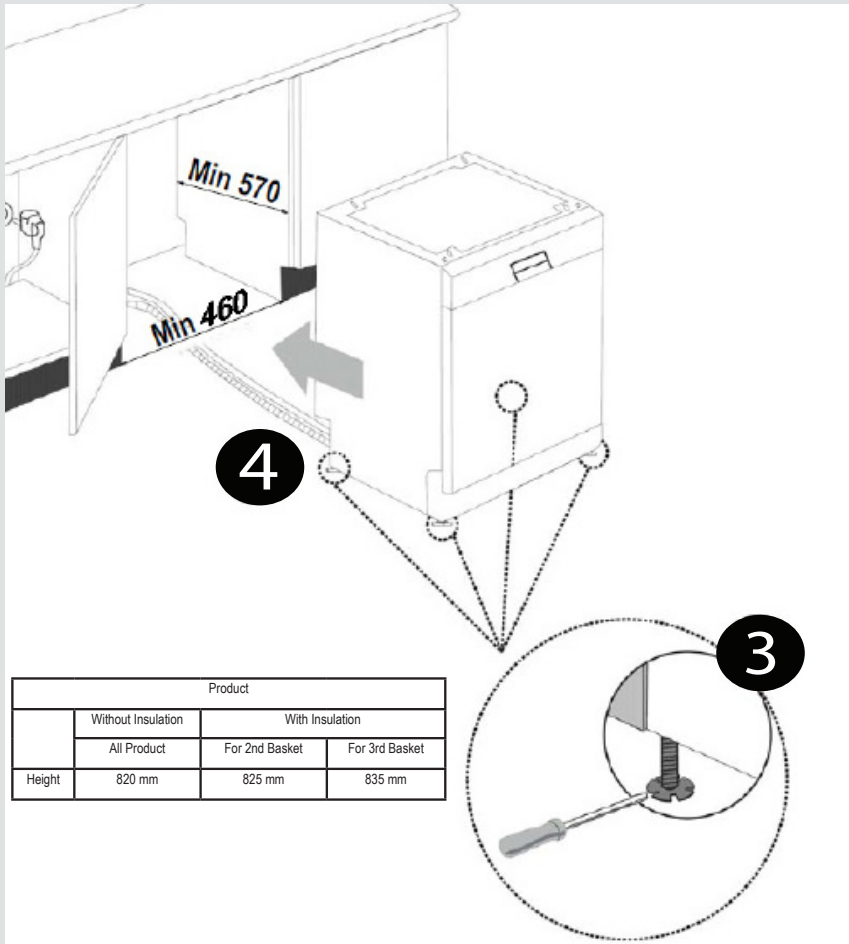

Warning: After removal of the worktop, the machine should be placed in such a closed place of which dimensions are shown at fig.

CHAPTER -4: PREPARING THE MACHINE FOR USE

Prior to using the machine for the first time

- Check whether the electricity and supply water specifications match the values indicated by the installation instructions for the machine.
- Remove all packaging materials inside the machine.
- Set the water softener.
- Add 1 kg salt into the salt compartment and fill with water up to a level at which it will almost overflow.
- Fill the rinse aid compartment.

PREPARING THE MACHINE FOR USE

The importance of water decalcification

For a good washing function, the dishwasher needs soft, i.e. less calcareous water. Otherwise, white lime residues will remain on the dishes and the interior equipment. This will negatively affect your machines' washing, drying and shining performance. For this reason, a softener system used on dishwashers. The softener system has to be refreshed so that it operates with the same performance also during the next wash. For this purpose, dishwasher salt is used.

Filling with salt

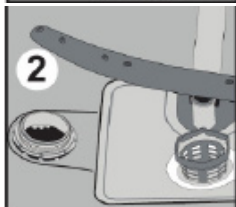
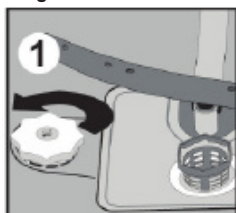

Use softener salt specifically produced for use in dishwashers. To add softener salt, first remove the lower basket and then open the salt compartment cap by turning it counter clockwise. (1) (2) At first use fill the compartment with 1 kg salt and water (3) at overflowing level. If available. Using a funnel (4) will make filling easier. After every 20th-30th wash, add salt into your machine until it fills up (approx. 1 kg). Fill the salt compartment with water at first use only. We recommend to use small grained or powder softener salt. Do not put table salt into your machine, otherwise the function of the softener compartment may decrease over time. When you start the machine, the salt compartment gets filled with water. Therefore, put the softener salt prior to starting your machine. This way, overflowing salt gets immediately cleaned up through the wash operation. If you will not wash any dishes immediately after putting salt, then run a short washing program with an empty machine in order to avoid corrosion on your machine due to the salt overflow while filling in the salt container. In order to understand whether or not the amount of

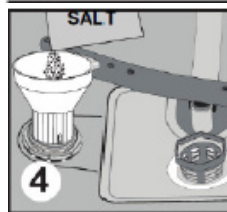

softener salt in machine is sufficient, check the transparent section on the salt compartment cap. There is sufficient salt if the transparent section is green. Salt has to be added if it is not green.

Testing strip

The washing effectiveness of your machine depends on the softness of the tap water. For this reason, your machine is equipped with a system that reduces the hardness in mains water supply. The washing effectiveness will increase when the system is correctly set. To find out the water hardness level of water in your area, contact your local water board or determine water hardness level by using the test strip (if available).

Open the testing strip	Run water through your tap for 1 min.	Keep the testing strip in water for 1.sec.	Shake the testing strip after taking it out of water	Water for 1 min.	Make your machine's water hardness setting according to the result obtained through the testing strip.	
					Level 1	No Lime
					Level 2	Very low lime content
					Level 3	Low lime content
					Level 4	Medium lime content
					Level 5	Lime content
					Level 6	High lime content

CHAPTER -4: PREPARING THE MACHINE FOR USE

Adjusting salt consumption

Water hardness level	German hardness level dH	French hardness level dF	British hardness level dE	Hardness Level Indicator
1	0-5	0-9	0-6	L1 is seen on display.
2	6-11	10-20	7-14	L2 is seen on display.
3	12-17	21-30	15-21	L3 is seen on display.
4	18-22	31-40	22-28	L4 is seen on display.
5	23-31	41-55	29-39	L5 is seen on display.
6	32-50	56-90	40-63	L6 is seen on display.

Adjust the water hardness setting of your machine according to the level specified on the test strip.

NOTE: Hardness level is adjusted to level 3 as a factory setting.

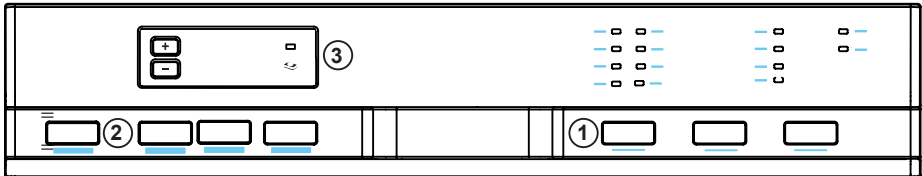

Push the Programme selection button and hold down. (1)

In the meantime, energize the machine by pushing ON/OFF button. (2)

Hold down the programme selection button until "SL" on the screen goes off. After "SL" goes off, release the programme button. (1)

The machine will show the last water softening setting carried out.

You can make water hardness setting by pressing on "+" and "-" buttons on the display. (3)

After making water hardness setting, memorize the chosen setting by pushing ON/OFF button.(2)

Detergent usage

Use a detergent specifically designed for use in domestic dishwashers.

You can find powder, gel, and tablet detergents that have been designed for household dishwashers.

Detergent should be put into the compartment prior to starting the machine. Keep your detergents in cool, dry places out of reach of your children.

Do not overfill the detergent compartment; otherwise it may cause scratches on your glasses as well as lead to a poorly dissolved detergent.

Should you need more information concerning the detergent you will use, contact the detergent manufacturers directly.

Filling the detergent compartment

Push the latch to open the detergent container as shown in the image. 1 The Detergent pod has level lines inside. The Detergent pod can take a total of 40 cm³ of detergent. Open the dishwasher detergent and pour into the larger compartment **b** 25 cm³ if dishes are heavily soiled or less 15 cm³. 2 If dishes have been kept dirty for a very long time with, dried food waste on them or the dishwasher has been overloaded pour **a** 5cm³ of detergent into the prewash compartment and start the machine. You may have to add more detergent into your machine, depending on the degree of soil and on the water hardness level in your area.

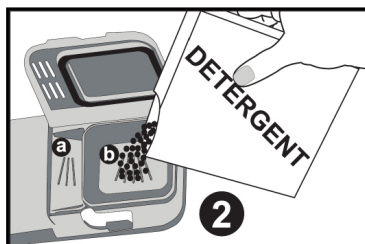
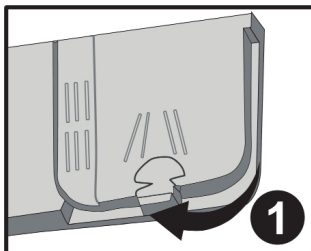

CHAPTER -4: PREPARING THE MACHINE FOR USE

Combined detergents

Combined detergents may include various properties in them. Before using a detergent, please read and follow the instructions well. Generally, combined detergents produce sufficient results only under certain conditions.

Points to consider when using these types of products:

- Check the specifications of the product whether it is combined or not.
- Check if the detergent used is appropriate for the hardness of the main water supply.
- Read the instructions of the products on the packagings.
- Always put the tablets into the detergent compartment in the detergent dispenser.
- You need to contact the manufacturers and find out about the suitable conditions of use.
- If you use appropriate products, they can ensure savings in salt and/or rinse agent consumption.
- The scope of the warranty for your machine does not cover any complaints caused by the use of these types of detergents.

Recommended usage: If you want to obtain better results while using combined detergents, add salt and rinse agent into your machine and adjust the water hardness setting and the rinse aid setting to the lowest position.



The solubility of the tablet detergents produced by different companies can vary depending on the temperature and time. Therefore, the use of such detergents in short programmes is not recommended. It is more suitable to use powder detergents for such programmes.

Warning: Should any problem, which you have not encountered before arise with the use of this type of detergents, contact the detergent manufacturers directly.

When you give up using combined detergents

- Fill the salt and rinse agent compartments.
- Adjust the water hardness setting to the highest position and run an empty-wash.
- Adjust the water hardness level.
- Set the suitable rinse agent setting.

Filling with rinse agent and making the setting

An adequate amount of rinse aid prevents white water drops, lime stains and white film strips. It also increases drying performance.

To add the rinse agent, remove the rinse agent compartment cap by turning it. **1** Fill the rinse agent compartment with rinse agent until the rinse agent level indicator becomes dark; **2** refit the cap and close it by turning it in a way that the nails correspond to one another. By checking the rinse agent level indicator on the detergent dispenser, you can check to see whether your machine needs rinse aid or not. A dark indicator **b** means that there is rinse agent in the compartment, while a light indicator **a** shows that you need to fill the compartment with rinse agent.

The rinse aid level adjuster can be set to a position between 1 and 6. The factory setting for rinse aid is the position **3**.

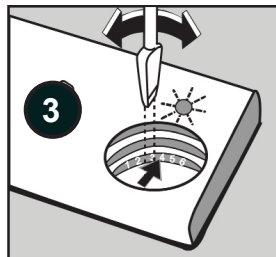
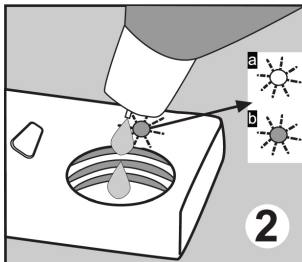
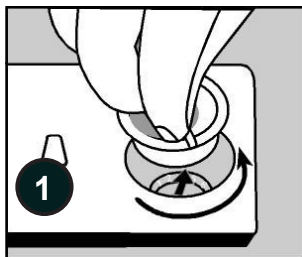

You need to increase the degree of the adjuster if water stains form on your dishes after a wash, whereas you need to decrease the degree if a blue stain is left when wiped by hand. 3

Warning: Use only those rinse agent materials which are allowed for use in the machine. As rinse agent residues left as a result of overflowing will create extremely high amounts of foam and thus reduce the washing performance, remove the excess amount of the rinse agent by wiping it with a rag.

CHAPTER-5: LOADING YOUR DISHWASHER

LOADING YOUR DISHWASHER

Place dishes properly into the machine.

There are two separate baskets to load dishes into your machine. The lower basket is for round and deep items. The upper basket is for thin and narrow items. You are recommended to use the cutlery basket in order to obtain the best result.

To avoid any possible injuries, place long-handle and sharp-pointed knives with their sharp points facing down or horizontally on the baskets.

Warning: Place your dishes into your machine in a way that they will not prevent the upper and lower spray arms from spinning.

Dish rack

There are dish racks on the upper basket of your machine.

a b You can use these dish racks in open or closed position. When they are in open position **a** you can place your cups on them; and when in closed position **b** you can place long glasses on the basket. Also, you can use these racks by placing long forks, knives and spoons on them laterally.

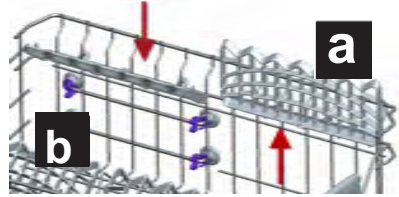

Folding Racks

Foldable racks on the upper basket are designed in order to let you place big items easier such as pots, pans, etc. If requested, each part can be folded separately, or all of them can be folded and larger spaces can be obtained. You can use foldable racks by raise them upwards, or by folding down.

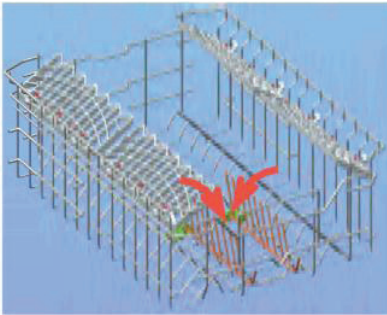

CHAPTER-5: LOADING YOUR DISHWASHER

Top basket height adjustment while it is full

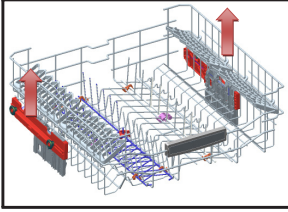

The basket height adjustment mechanism on the top basket of your machine is designed to let you adjust the height of your top basket upwards or downwards, without removing it from your machine when it is full, and create large spaces at the top or bottom area of your machine as needed. The basket of your machine is set to the upper position in factory settings. In order to raise your basket, hold it from both sides and pull it upwards. In order to lower it, hold it from both sides again, and leave it. In the loaded basket adjustment mechanism, make sure that both sides are in the same position (up or down).

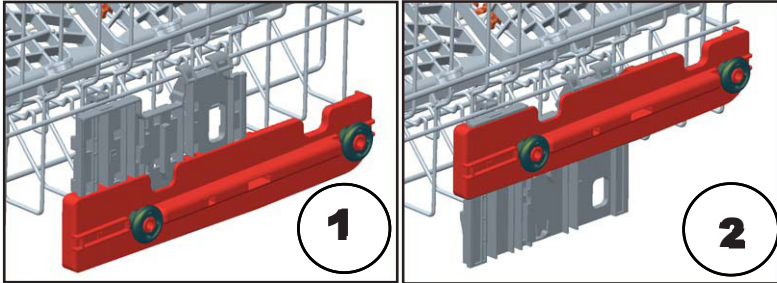

Lower Basket Folding Racks

Folding racks consisting of two parts that are located on the lower basket of your machine are designed in order to let you place big items easier such as pots, pans, etc. If requested, each part can be folded separately, or all of them can be folded and larger spaces can be obtained. You can use folding racks by raising them upwards, or by folding them down.

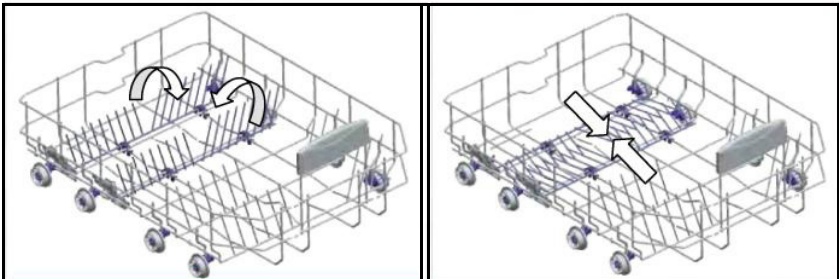

CHAPTER-5: LOADING YOUR DISHWASHER

Upper Cutlery Basket

The upper cutlery basket is designed for you to place forks, spoons and knives, long dippers and small items.

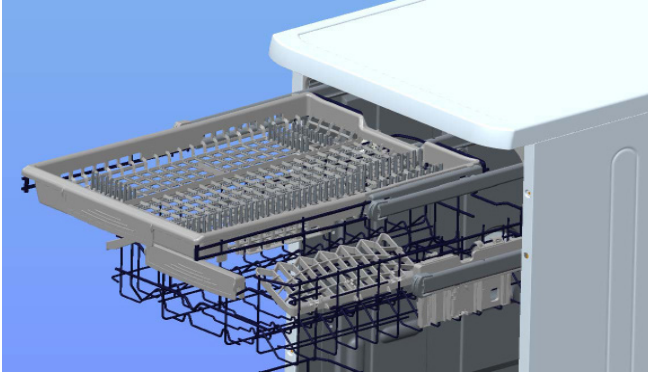

Because it can easily be taken out of the machine, it allows your dishes to be taken out of the machine along with the basket after washing.

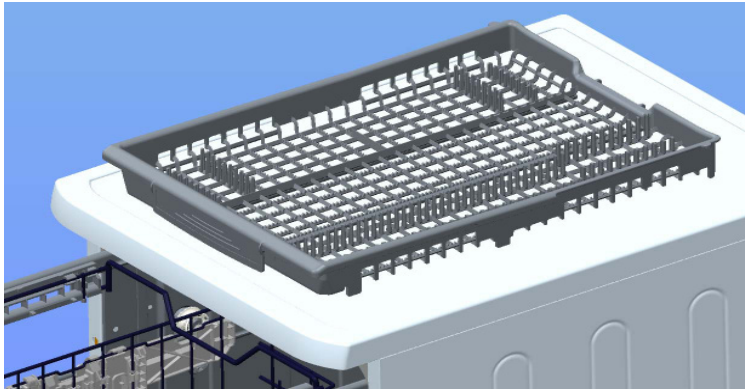

Warning: Knives and other sharp objects must be placed horizontally in the cutlery basket.

CHAPTER-5: LOADING YOUR DISHWASHER

Alternative basket loads
Lower Basket



Top basket

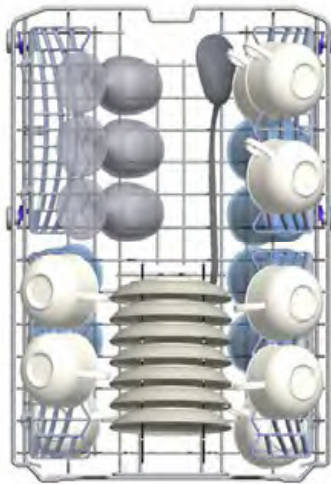

CHAPTER-5: LOADING YOUR DISHWASHER

Faulty loads

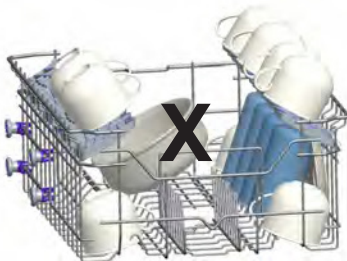
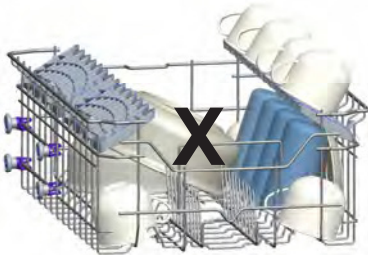
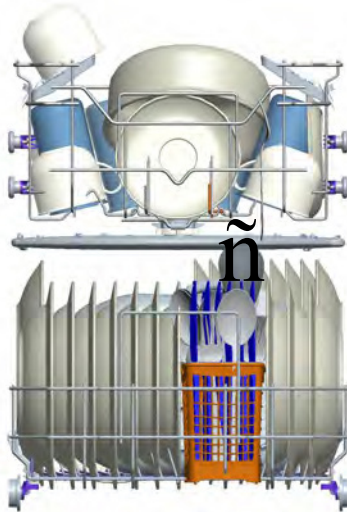

Important Note for Test Laboratories

For detailed information on performance tests, please contact following address: "dishwasher@standardtest.info" . In your email, please provide the model name and serial number (20 digits) which you can find on the appliance door.

CHAPTER -6: PROGRAMME DESCRIPTIONS

PROGRAMME DESCRIPTIONS

Programme items

Name of Program				
	Pre-washing	Auto Delicate	Auto Intense	Dual Wash
Washing Temperature	–	30-50°C	50-70°C	65°C
Type of Food Fragment	Fresh less dirty,cofee,milk, tea	Detects contamination level of dishes and sets temperature and amount of washing water and washing period automatically		soups, sauces,pasta, eggs, pilaf,potato and oven dishes, fried foodskept for long
Level of Contamination	small	small	high	high
Amount of Detergent B: 25 cm ³ / 15 cm ³ A: 5 cm ³	A**	B	B + A	B + A
	Pre-washing	Detects contamination level of dishes and sets temperature and amount of washing water and washing period automatically		40°C Wash
	End			65°C Wash
				45°C Wash
				Hot Rinse
				Dry
			End	
Program Period (minutes)	15	87-74	171-117	106
Power Consumption (kW hour)	0,02	0,75-0,9	1,20-1,85	1,43
Water Consumption (liters)	4,2	10,6-17,7	12,3-24,6	15,4

** Only powder detergent should be used in cycle of prewash programme.

CHAPTER -6: PROGRAMME DESCRIPTIONS

PROGRAMME DESCRIPTIONS

Programme items

Name of Program	Quick 30 min.	Eco	Express 50' min.	Hygiene 70°C
	Washing Temperature	40°C	50°C	65°C
Type of Food Fragment	Fresh coffee, milk, tea, cold meat, vegetables	coffee, milk, tea, cold meats, vegetables, not kept for long	soups, sauces, pasta, eggs, pilaf, potato and oven dishes, fried foods	Dishes with dense dirt waiting for a long time or requiring hygienic washing.
Level of Contamination	small	Medium	Medium	high
Amount of Detergent B: 25 cm ³ / 15 cm ³ A: 5 cm ³	B	B + A	B + A	B + A
	40°C Wash	50°C Wash	65°C Wash	50 °C wash
	Cold Rinse	Cold Rinse	Intermediate rinse	60°C Wash
	Hot Rinse	Hot Rinse	Hot rinse	Cold Rinse
	End	Dry	End	Hot Rinse
		End		Dry
				End
Program Period (minutes)	30	185	50	116
Power Consumption (kW hour)	0,7	0,65	1,31	1,38
Water Consumption (liters)	10,9	9,0	10,9	15,0

Warning: Short programs do not include a drying step.

The values declared above are the values obtained under laboratory conditions according to relevant standards. These values can change depending on conditions of product's use and environment (network tension, water pressure, water input temperature and environment temperature).

CHAPTER -7: SWITCHING ON THE MACHINE AND SELECTING A PROGRAMME

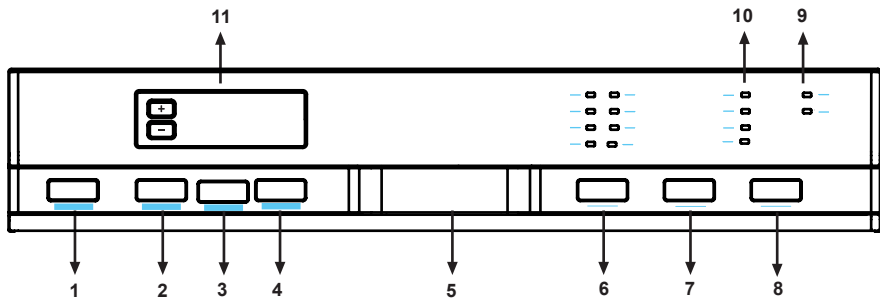

1.) ON/OFF Button

When pressed on ON/OFF button, the machine is energized and the light on Start/Standby button goes on.

2.) Extra Fast / Silent Button

Washes the dishes with more pressure, thus shortens the time of the selected program and provides economical water usage.

3.) Extra Silent Function

Washes the dishes with less pressure, thus provides more sensitive and silent washing.

4.) ½ Half Load Button

Using the function ½, three sorts of washing up can be done those being lower basket, upper basket and both baskets.



If you have little amount of dishes in your machine and if you have to wash them, you can also activate the semi-filling function in some of the programs additionally. If you have dishes in both baskets, press the key ½ and select the position in which both lamps are highlighted.



If you have dishes only in the upper basket, press the key ½ and select the position in which the upper lamp is illuminated. Thus, washing up shall be done only on the upper basket of your machine. No dishes should certainly be available in the lower basket while using this feature.



If you have dishes only in the lower basket, press the key ½ and select the position in which the lower lamp is illuminated.

Thus, washing up shall be done only on the lower basket of your machine. In using this feature, make sure that there are no dishes in the upper basket.

Note : If you have used an extra feature on the latest washing program, this feature will remain active also on the next washing program. If you do not want to use this feature on the newly selected washing program, press the selected feature button again, and check that the lamp on the button goes off.

5.) Door Handle

The door handle is used to open/close the door of your machine.

6.) Programme selector Button

With the program selector button, you can select a suitable program for your dishes.

7.) Energy Save Button

This option supports opening the door at the end of the program. So drying efficiency is increased. In addition, the option decreases temperature at the algorithm of programs to support energy saving.

8.) Start/Pause Button

Once you press the Start/Pause button, the programme you selected with the programme selector button will start running and the status indicator lamp "wash" will light up. In the stop condition while wash led is On, Start/Pause led will blink.

CHAPTER -7: SWITCHING ON THE MACHINE AND SELECTING A PROGRAMME

9.) Salt Lack Warning indicator

In order to see whether softening salt in your machine is sufficient or not, check salt lack warning light on the display. When salt light warning light starts coming on, you need to fill in the salt chamber.

Rinse aid Lack Warning indicator

In order to check that there is sufficient rinse aid in your machine check rinse aid lack warning light on the display. When rinse aid warning light starts coming on, fill in rinse aid chamber.

10.) Program Monitor Lights

Program flow can be monitored via program monitor lights on control panel.

- Wash
- Rinse
- Dry
- End

11.) Remaining Time Indicator

Remaining Time Indicator displays the program times and remaining time during the program is in operation. In addition, you can adjust program delay time by pressing the buttons on the indicator before program starts. If you want to change delay time, you can set the time by pressing Start/Pause button and using buttons on the indicator. Press Start/Pause button again in order to activate.

Child Lock Operation

In order to activate child lock, press "+" and "-" buttons on the indicator for 3 seconds. To deactivate child lock, press "+" and "-" buttons again simultaneously for 3 seconds. "CL" will blink for 1 time.

CHAPTER -7: SWITCHING ON THE MACHINE AND SELECTING A PROGRAMME

Switching on the machine

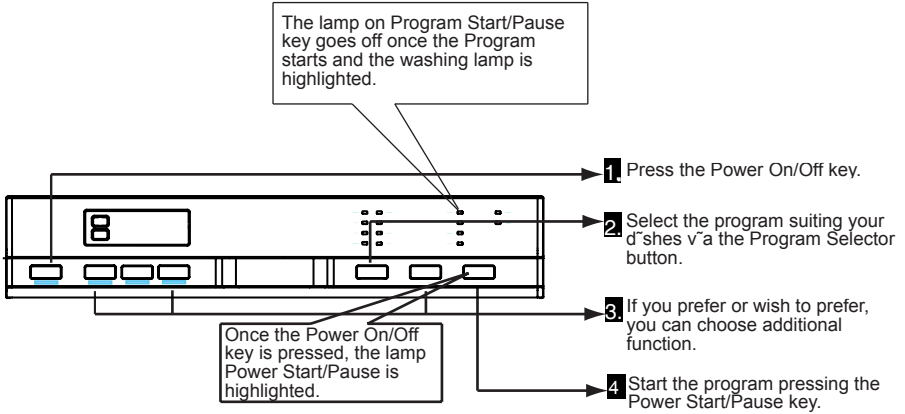

Program follow-up

You can follow the program flow using the program follow-up lamps located on the control panel.

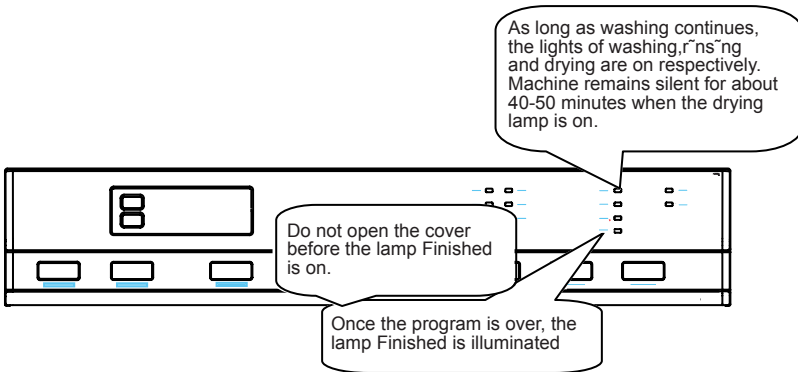

Changing a programme

If you would like to change programs while a washing program is continuing.

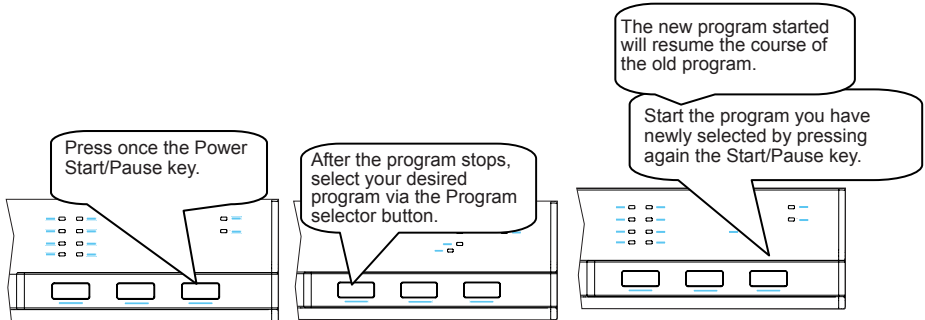

CHAPTER -7: SWITCHING ON THE MACHINE AND SELECTING A PROGRAMME

Changing a programme with resetting

If you would like to cancel a program while a washing program is resumed.

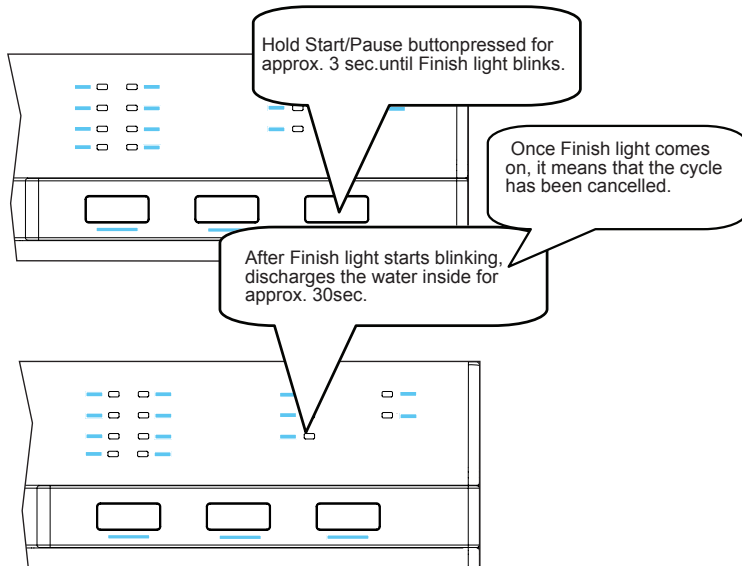

Switching the machine off

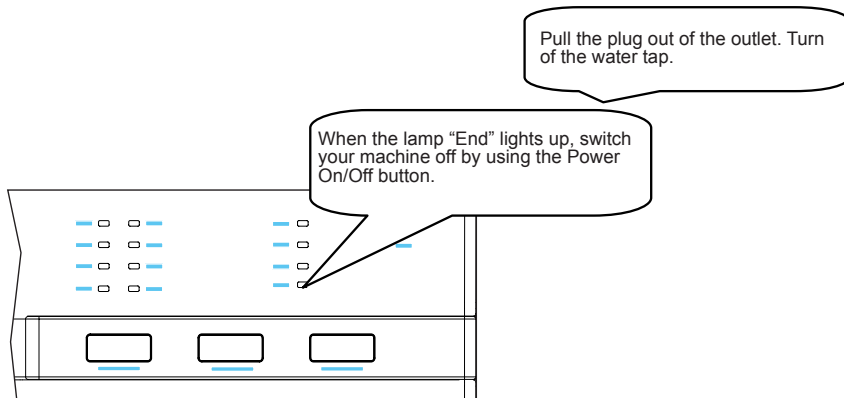

Note: You can slightly open the door in order for the machine to perform a faster dry operation after the wash programme is finished.

Note: If the machine door opens during washing or the power is cut off, the machine will go on to the program in case the door is shut or the power is back.

CHAPTER -8: MAINTENANCE AND CLEANING

Cleaning the machine regularly prolongs the machine's service life.

Oil and limescale may accumulate in the machine's washing section. In case of such accumulation;

-Fill the detergent compartment without loading any dishes into the machine, run the machine at high temperature. If this does not work, use special cleansing materials.

Cleaning the seals in the machine door,

-Wipe the seals regularly by using a dampened cloth.

Cleaning machine,

Clean the filters and spray arms at least once a week.

Unplug your machine and turn off its tap before starting the cleaning.

Wipe with a fine cleaning material and a dampened cloth.

Filters

If any food wastes have remained on the coarse and fine filters, remove the filters and clean them thoroughly under the water tap.

a. Micro Filter

b. Coarse Filter

c. Metal/Plastic Filter

To remove and clean the filter combination, turn it counter clockwise and take it out by lifting upwards. **1**

Pull and remove the metal/plastic filter. **2** Then pull the coarse filter out of the micro filter. **3** Rinse it with lots of water under the tap. Refit the metal/plastic filter. Insert the coarse filter into the micro filter in a way that the marks correspond to one another. Attach micro filter into the metal/plastic filter and turn to the direction of arrow and it is locked when the arrow on micro filter can be seen from across. **4**

• Never use your dishwasher without a filter.

• Incorrect fitting of the filter will reduce the washing effectiveness.

• Clean filters are very important in terms of the proper running of the machine.

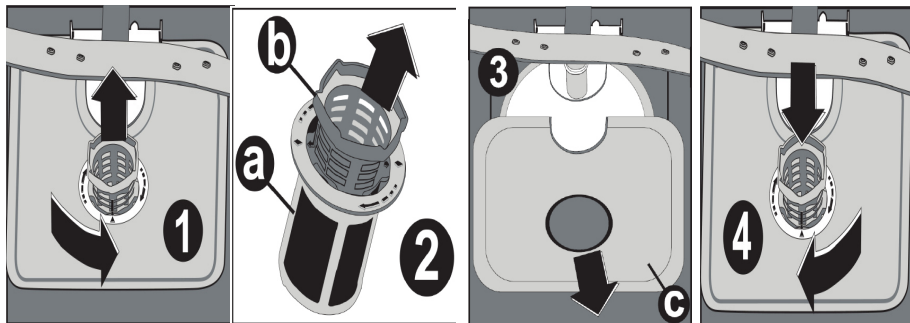

Spray arms

Check the holes for the upper and lower spray arms. If there is any clogging, remove the spray arms and clean them under water.

You can remove the lower spray arm by pulling it upwards, while the upper spray arm nut can be removed by turning the nut to the left. Be sure that the nut is perfectly tightened when refitting the upper spray arm.

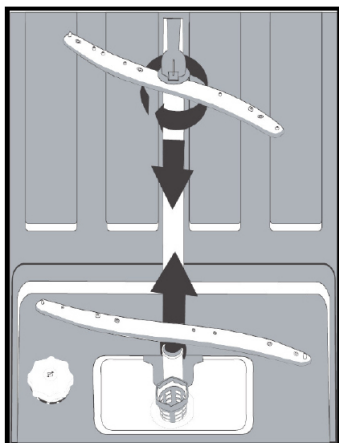

Hose filter

Check the filter and the hose from time to time and clean them to prevent yellowing and formation of deposits after washing. To clean the filter, first turn off your tap and then remove the hose. After removing the filter from the hose, clean it under the tap. Insert the cleaned filter back into its place inside the hose. Refit the hose.

CHAPTER -9: FAILURE CODES AND WHAT TO DO IN CASE OF FAILURE

ERROR CODE	ERROR DESCRIPTION	CONTROL
F5	Inadequate water supply	<ul style="list-style-type: none"> • Make sure the water input tap is totally open and that there is no water cut. • Close the water input tap, separate the water input hose from the tap and clean the filter at the connection end of the hose. • Restart your machine, contact for service if the error resumes.
F3	Error of continuous water input	<ul style="list-style-type: none"> • Close the tap. • Contact service.
F2	The waste water in the machine cannot be discharged.	<ul style="list-style-type: none"> • Water discharge hose is clogged. • The filters of your machine might be clogged. • Power off-on your machine and activate the program cancellation command. • If the error continues, contact for service.
F8	Heater error	<ul style="list-style-type: none"> • Contact for service.
F1	Alarm is active against water overflow	<ul style="list-style-type: none"> • Power off your machine and close the tap. • Contact for service.
FE	Faulty electronic card	<ul style="list-style-type: none"> • Contact for service.
F7	Overheating error (temperature in the machine is too high)	<ul style="list-style-type: none"> • Contact for service.
F9	Divisor position error	<ul style="list-style-type: none"> • Contact for service.
F6	Faulty heater sensor	<ul style="list-style-type: none"> • Contact for service.

If one of the program monitor lights is on and start/pause light is on and off,
Your machine's door is open, shut the door.

If the programme won't start

- Check if the plug is connected.
- Check your indoor fuses.
- Be sure that the water inlet tap is turned on.
- Be sure that you have closed the machine door.
- Be sure that you switched off the machine by pressing the Power On / Off button.
- Be sure that the water inlet filter and the machine filters are not clogged.

If the lamps "Wash/Dry" and "End" keep flashing

- The water overflow alarm is active
- Turn off your tap and contact the Sharp helpdesk.

If the control lamps won't go out after a wash operation

Check if the Power On/Off button is released.

If detergent residues are left in the detergent compartment

Detergent has been added when the detergent compartment was wet.

If water is left inside the machine at the end of the programme

- The water drain hose is clogged or twisted.
- The filters are clogged.
- The programme is not finished yet.

If the machine stops during a wash operation

- Power failure.
- Water inlet failure.
- Program can be on standby mode.

If shaking and hitting noises are heard during a wash operation

- Dishes placed incorrectly.
- Spray arm hitting the dishes.

If there are partial food wastes left on the dishes

- Dishes placed incorrectly into the machine, sprayed water did not reach related places.
- Basket overly loaded.
- Dishes leaning against one another.
- Small amount of detergent added.
- An unsuitable, rather weak wash programme selected.
- Spray arm clogged with food wastes.
- Filters clogged.
- Filters incorrectly fitted.
- Water drain pump clogged.

CHAPTER -10: PRACTICAL AND USEFUL INFORMATION

If there are whitish stains on the dishes

- insufficient detergent is being used
- Rinse aid dosage setting at a very low level.
- No special salt is being used despite the high degree of water hardness.
- Water softener system setting is at a very low level.
- Salt compartment cap not closed well.

Won't dry no need for dry

- A programme without a dry operation has been selected.
- Rinse aid dosage set too low
- Dishes unloaded too fast.

If there are rust stains on the dishes

- Stainless-steel quality of the dishes washed is insufficient.
- High rate of salt in the wash water.
- Salt compartment cap not properly closed.
- Too much salt spilt into the sides and into the machine while filling it with salt.
- Poor mains grounding.

Call an authorised service if the problem still persists after the controls or in case of any malfunction not described above.

PRACTICAL AND USEFUL INFORMATION

- 1- When you won't be using your machine for an extended period
 - Unplug the machine and then turn the water off.
 - Leave the door slightly ajar in order to prevent the formation of unpleasant smells.
 - Keep the machine interior clean.
- 2- Eliminating water droplets
 - Wash the dishes with the intensive programme.
 - Take all of the metal containers in the machine out.
 - Do not add detergent.
- 3- If you properly place your dishes into the machine, you will be using it in the best way in terms of energy consumption, washing and drying performance.
- 4- Clean all rough waste before you place dirty dishes to the machine.
- 5- Operate the machine after it is completely full.
- 6- Use a pre-washing program only when necessary.
- 7- Observe program information and average consumption values table when selecting a program.
- 8- Since the machine will reach high temperatures, it should not be placed near a refrigerator.
- 9- If the appliance is located in a place where the risk of freezing exists, you must completely drain the water that has remained in the machine. Turn off the water tap, disconnect the water inlet hose from the tap and allow the interior water to drain.

The dishwasher contains biocidal product in the PP sump filter to prevent bacterial growth.
Active Substance: zinc pyrithione (CAS No: 13463-41-7)

DISPOSAL OF YOUR OLD MACHINE

This symbol on the product or package implies that the product should not be treated as domestic waste. Instead, it should be delivered to waste collection places recycling electrical and electronic equipment. You will help avoid damage to the environment and risks to public health. Recycling materials will help natural resources to be preserved. For more detailed information regarding recycling of this product, please contact your local authority or the shop where you purchased the product from.



Register your product here
WWW.SHARPHOMEAPPLIANCES.COM,
by registering with Sharp you become part of
our For Life promise to always be there for you
and your appliance.



Service
& Support

Visit our website:

www.sharphomeappliances.com

Or contact us:



You **Tube**

%100 recycleable paper

52221975 R25