



QW-HS24F472I-FR  
QW-HS24F472S-FR  
QW-HS24F472W-FR

Dishwasher

EN User Manual



# CONTENTS

<b>CHAPTER-1: EXPLANATION OF PRODUCT</b>	
Technical specifications .....	5
Conformity with the standards and test data .....	5
<b>CHAPTER-2: SAFETY INFORMATION AND RECOMMENDATIONS</b>	
Recycling .....	6
Safety information .....	6
Recommendations .....	8
Items not suitable for dishwashing .....	8
<b>CHAPTER-3: INSTALLING THE MACHINE</b>	
Positioning the machine .....	8
Water connections .....	9
Water inlet hose .....	9
Water outlet hose .....	9
Electrical connection .....	10
Fitting the machine undercounter .....	11
Prior to using the machine .....	13
<b>CHAPTER-4: PREPARING THE MACHINE FOR USE</b>	
The importance of water decalcification .....	13
Filling with salt .....	13
Testing strip .....	13
Adjusting salt consumption .....	14
Detergent usage .....	14
Filling the detergent compartment .....	14
Combined detergent .....	15
Filling with rinse aid and making the setting .....	15
<b>CHAPTER-5: LOADING YOUR DISHWASHER</b>	
Height Adjustable Rack .....	16
Alternative basket loads .....	18
<b>CHAPTER -6: PROGRAMME DESCRIPTIONS</b>	
Programme items .....	20
<b>CHAPTER -7: SWITCHING ON THE MACHINE AND SELECTING A PROGRAMME</b>	
Programme Selection and Operating the Machine .....	22
Changing a programme .....	23
Cancelling a programme .....	23
Switching the Machine Off .....	24
<b>CHAPTER-8: MAINTENANCE AND CLEANING</b>	
Filters .....	25
Spray arms .....	25
Hose filter .....	25
<b>CHAPTER-9: FAILURE CODES AND WHAT TO DO IN CASE OF FAILURE</b>	26
<b>CHAPTER-10: PRACTICAL AND USEFUL INFORMATION</b>	27

Dear Customer, our goal is to offer you, high quality products that exceed your expectations. Your appliance is produced in modern facilities and is carefully tested for quality.

Before using your appliance, carefully read this guide which includes basic information for safe installation, maintenance and use.

The operating instructions apply to several models. Differences may therefore occur.

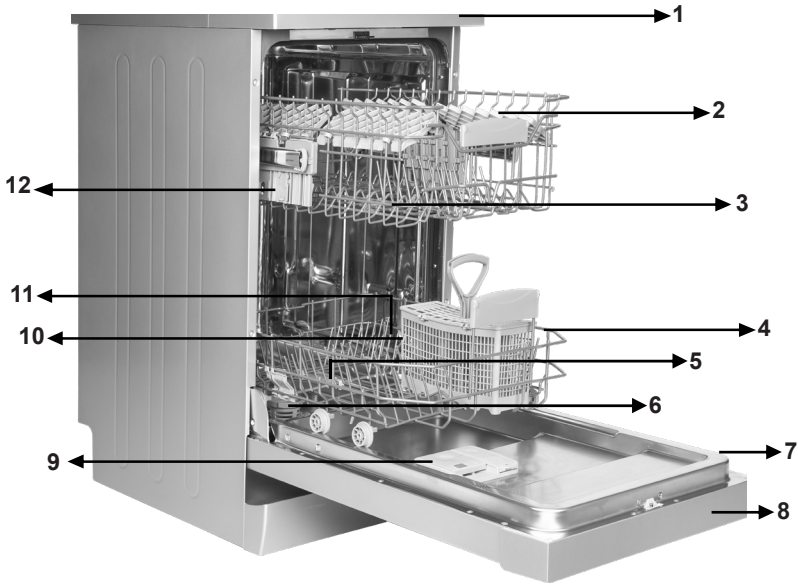

- 1. Worktop
- 2. Upper basket with racks
- 3. Upper spray arm
- 4. Lower basket
- 5. Lower spray arm
- 6. Filters
- 7. Rating plate
- 8. Control Panel
- 9. Detergent and rinse-aid dispenser
- 10. Cutlery basket
- 11. Salt dispenser
- 12. Upper basket track latch



13

**Turbo Drying Unit:**

This system provides better drying performance for your dishes.

## CHAPTER -1: TECHNICAL SPECIFICATIONS

### Technical specifications

Capacity	10 place settings
Height	850 mm
Height (without worktop)	820 mm
Width	450 mm
Depth	598 mm
Net Weight	40 kg
Electricity input	220-240 V, 50 Hz
Total Power	1900 W
Heating Power	1800 W
Pump Power	100 W
Drain Pump Power	30 W
Water supply pressure	0.03 MPa (0,3 bar)-1 MPa (10 bar)
Current	10 A

### Conformity with the standards and Test data / EU Declaration of Conformity

This product meets the requirements of all applicable EU directives with the corresponding harmonised standards, which provide for CE marking.

Please visit [www.sharphomeappliances.com](http://www.sharphomeappliances.com) for an electronic copy of this user manual.

### SAFETY INFORMATION AND RECOMMENDATIONS

#### Recycling

- The recyclable materials are used in certain components and packaging.
- Plastic parts are marked with international abbreviations: (>PE< , >PS< , >POM<, >PP<, )
- Cardboard parts have been produced from recycled paper which should be disposed of into waste paper collection containers for recycling.
- Such materials are not suitable for garbage bins. They should be delivered to recycling centres instead.
- Contact relevant centres in order to obtain information on methods and points of disposal.

#### Safety Information

##### When you take delivery of your machine

- If you see any damage on your machine's packaging, please contact the authorised service.
- Unwrap the packaging materials as indicated and dispose of them in accordance with the rules in force.

##### Points to pay attention during machine installation

- Choose a suitable, safe and level place to install your machine.
- Carry out the installation and connection of your machine by following the instructions.
- This machine should only be installed and repaired by an authorised service technician.
- Only original spare parts should be used with the machine.
- Before installing, be sure that the machine is unplugged.
- Check whether the indoor electrical fuse system is connected according to the regulations.
- All electrical connections must match the values on the rating plate.
- Be sure that the machine does not stand on the electricity supply cable.
- Never use an extension cord or a multiple socket for making a connection. The plug should be comfortably accessible after installation.
- After installation, run it unloaded for the first time.

##### In daily use

- This machine is for household use; do not use it for any other purpose. Commercial usage of the dishwasher will void the warranty.
- Do not get up, sit or place a load when the door is open, it may fall over.
- Never use a detergent and rinse agent which is not produced specifically for dishwashers. Our company will not be liable for this.
- The water in the machine's washing section is not drinking water. Do not drink it.

## CHAPTER -2: SAFETY INFORMATION AND RECOMMENDATIONS

- Due to danger of explosion, do not put any chemical dissolving agents such as solvents into the machine's washing section.
- Check whether plastic items are heat-resistant before washing.
- This appliance can be used by children aged 8 years and over and persons with reduced physical, sensory or mental capabilities or lack of experience and knowledge if they have been given supervision or instruction concerning use of the appliance in a safe way and understand the hazards involved. Children shall not play with the appliance. Cleaning and user maintenance should not be carried out by children without supervision.
- Do not put unsuitable and heavy items above the basket's capacity into your machine. Our company will not be liable for any damage on the internal parts.
- The door must not open while the machine is operating. In any case, the safety device ensures that the machine stops if the door is opened.
- Do not leave the door open, to avoid accidents.
- Place knives and other sharp-ended objects in the cutlery basket in blade-down position.
- If the supply cord is damaged, it must be replaced by the manufacturer, its service agent or competent technician in order to prevent a hazard.
- If the Energy Save option is selected as "Yes", The door will be opened at the end of the programme. Do not force the door shut to avoid harm to the auto door mechanism for 1 minute. The door must be open for 30 minutes for effective drying.(in models with an auto door opening system)

**Warning:** Do not stand in front of the door after the signal for the auto-open sounds.

### **For your children's safety**

- After removing the machine's packaging, make sure that the packaging material is out of reach of children.
- Do not allow children to play with or start the machine.
- Keep children away from detergents and rinse agents.
- Keep children away from the machine while it is open as there may still be cleaning substance residues inside the machine.
- Be sure that your old machine does not pose any threat to your children. Children are known to have gotten themselves locked in old machines. To forestall such a situation, break your machine's door lock and tear off the electrical cables.

### **In case of malfunctioning**

- Any repairs performed by anyone other than authorized service staff will result out of scope warranty to your machine.
- Prior to any repair work on the machine, be sure that the machine is cut off from the power supply. Switch off the fuse or unplug the machine. Do not pull by the cable when unplugging. Make sure to turn off the water tap.

### Recommendations

- For energy and water saving, remove coarse residues on your dishes before placing the dishes into the machine. Start your machine after having fully loaded it.
- Use the pre-wash programme only whenever necessary.
- Place such hollow items as bowls, glasses and pots into the machine in such a way so they face down.
- You are recommended not to load into your machine any dishes different or more than indicated.

### Items not suitable for dish washing:

- Cigarette ashes, candle wax, polish, paint, chemical substances, iron-alloy materials;
- Forks, spoons and knives with wooden, bone, ivory or nacre-coated handles; glued items, items soiled with abrasive, acidic or base chemicals.
- Plastic items that are not heat-resistant, copper or tin-coated containers.
- Aluminium and silver objects (they may discolour, become dull).
- Certain delicate glass types, porcelains with ornamental printed patterns as they fade even after the first wash; certain crystal items as they lose their transparency over time, adhered cutlery that is not heat-resistant, lead crystal glasses, cutting boards, items manufactured with synthetic fibres;
- Absorbent items such as sponges or kitchen rags are not suitable for dishwashing.

**Warning:** Make sure to purchase dishwasher-safe sets in your future purchases.

## INSTALLING THE MACHINE

### Positioning the machine

When determining the installation place, ensure an accessible place for easy loading and unloading of dishes.

Do not put your machine in any location where there is a probability of the room temperature falling below 0°C.

Before positioning, take the machine out of its packaging by following the warnings located on the packaging.

Position the machine close to a water tap or drain. You need to site your machine, taking into consideration that its connections cannot be altered once they are made.

Do not grip the machine by its door or panel in order to move it.

Take care to leave sufficient clearance from all sides of the machine to comfortably move it back and forth during cleaning. Make sure that the water inlet and outlet hoses do not get squeezed while positioning the machine.

Also, make sure that the machine does not stand on the electrical cable.

Adjust the machine's adjustable feet so that it can stand level and balanced.

The proper positioning of the machine ensures problem-free opening and closing of the door.



## CHAPTER -3: INSTALLING THE MACHINE

If the door of the machine does not close properly, check if the machine is stable on the floor on which it stands; if not, adjust the feet and ensure its stable position.

### Water connection

Indoor plumbing must be suitable for installing a dishwasher. We also recommend that you fit a filter at the entrance of your house or apartment so as to avoid any damage to your machine as a result of any contamination (sand, clay, rust etc.) that might be occasionally carried in through the main water supply or the indoor plumbing, and to forestall such complaints as yellowing and the formation of deposits after washing.

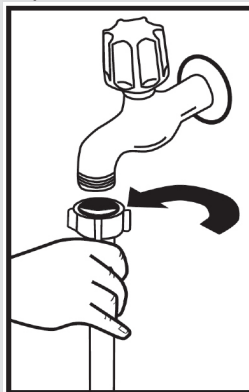

### Water inlet hose

Do not use the water inlet hose of your old machine. Use the new hose supplied with your machine. If you connect a new or long - unused water inlet hose to your machine, run water through it for a while before making the connection. Connect the water inlet hose directly to the water inlet tap. The pressure supplied by the tap should be at a minimum of 0.03 Mpa and at a maximum of 1 Mpa. If the water pressure is above 1 Mpa, a pressure-relief valve should be fitted in between.

After making connections, the tap should be turned on fully and checked for water tightness. For the safety of machine, turn off the water inlet tap after finishing each wash programme.

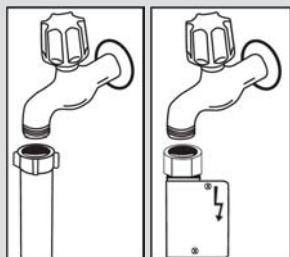

**NOTE:** An aquastop water spout is used in some models. In the event of using Aquastop, a dangerous tension exists. Do not cut Aquastop water spout. Do not let it get folded or twisted.

### Water outlet hose

The water drain hose can be connected either directly to the water drain hole or to the sink outlet spigot. Using a special bent pipe (if available), the water can be drained directly into the sink via hooking the bent pipe over the edge of the sink. This connection should be between 50 and 110 cm from the floor plane.

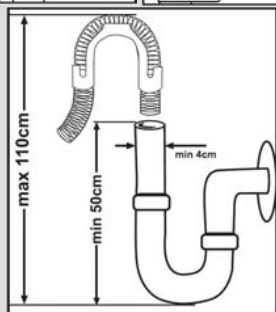

## CHAPTER -3: INSTALLING THE MACHINE

**Warning:** When a drain hose longer than 4 m is used, the dishes may remain dirty. In such a case, our company will not accept liability.

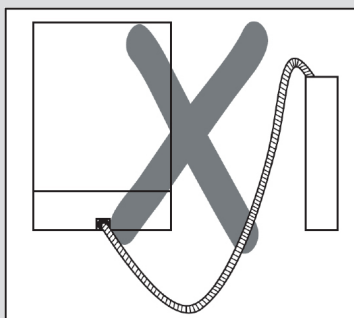
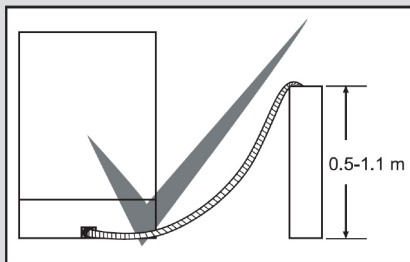

### Electrical connection

The grounded plug of your machine should be connected to an grounded outlet supplied by a suitable voltage and current. If there is no grounding installation, have a competent electrician carry one out. In the event of usage without installed grounding, our company will not be liable for any loss of usage that may occur.

The indoor fuse current value should be 10-16 A.

Your machine is set to 220-240 V. If the power supply voltage in your location is 110 V, connect a transformer of 110/220 V and 3000 W in between. The machine should not be plugged in during positioning.

Always use the coated plug supplied with your machine.

Operation in low voltage will cause a decline in washing quality.

The machine's electrical cable should be replaced by an authorised service or an authorised electrician only. Failure to do so may lead to accidents.

For safety purposes, always make sure to disconnect the plug when a wash programme is finished.

In order to avoid an electric shock, do not unplug when your hands are wet. When disconnecting your machine from the main supply, always remove by the plug. Never pull on the cord itself.

## CHAPTER -3: INSTALLING THE MACHINE

### Fitting the machine undercounter

If you wish to fit your machine undercounter, check whether you have sufficient space under your countertop and whether the wiring-plumbing is suitable to do so. **1** If you decide that the space under the countertop is suitable for fitting your machine, remove the worktop as shown in the illustration. **2**

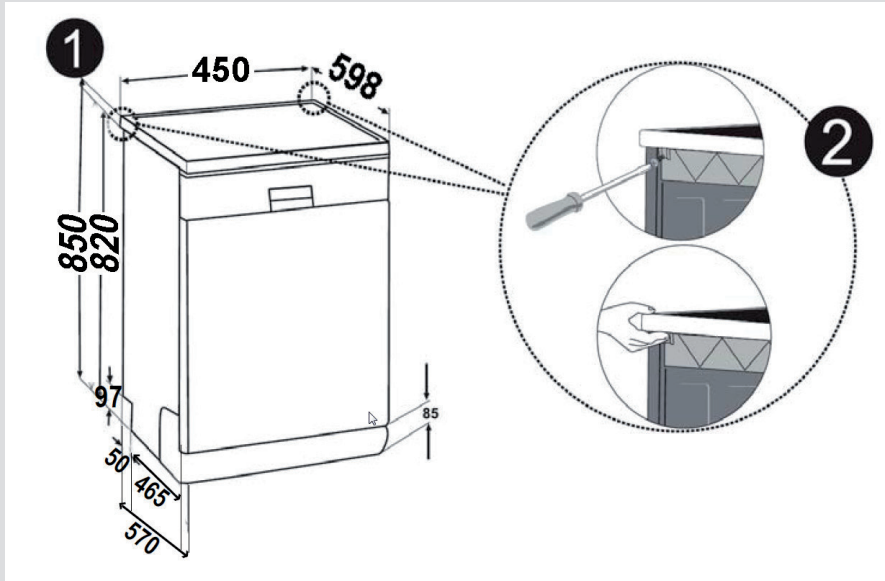

**Warning:** The surface which you place the machine under when removing its worktop has to be stable to avoid balance problems.

To remove the worktop, remove the screws that hold the worktop which are located at the rear of the machine; then push the front panel 1 cm from the front side towards the rear and lift it.

## CHAPTER -3: INSTALLING THE MACHINE

Adjust the machine's feet according to the slope of the floor. **3** Fit your machine by pushing it undercounter without letting the hoses get crushed or bent. **4**

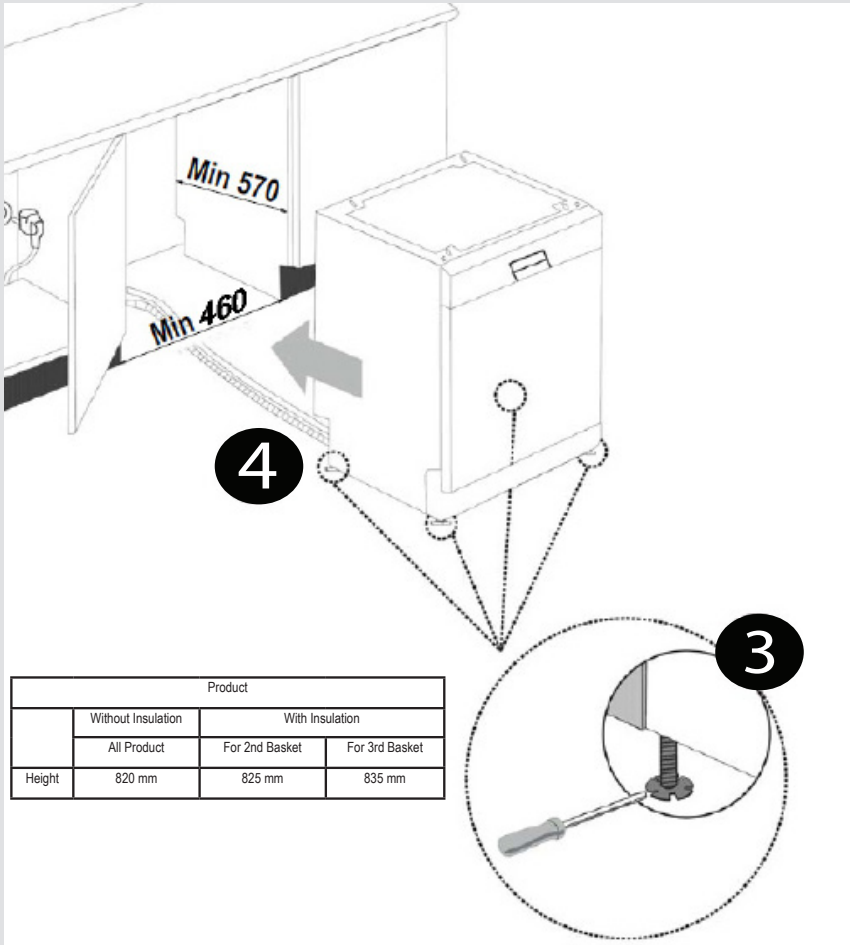

**Warning:** After removal of the worktop, the machine should be placed in such a closed place of which dimensions are shown at fig.

## CHAPTER -4: PREPARING THE MACHINE FOR USE

### Prior to using the machine for the first time

- Check whether the electricity and supply water specifications match the values indicated by the installation instructions for the machine.
- Remove all packaging materials inside the machine.
- Set the water softener.
- Add 1 kg salt into the salt compartment and fill with water up to a level at which it will almost overflow.
- Fill the rinse aid compartment.

### PREPARING THE MACHINE FOR USE

#### The importance of water decalcification

For a good washing function, the dishwasher needs soft, i.e. less calcareous water. Otherwise, white lime residues will remain on the dishes and the interior equipment. This will negatively affect your machine's washing, drying and shining performance. For this reason, a softener system used on dishwashers. The softener system has to be refreshed so that it operates with the same performance also during the next wash. For this purpose, dishwasher salt is used.

#### Filling with salt (IF AVAILABLE)



Use softener salt specifically produced for use in dishwashers. To add softener salt, first remove the lower basket and then open the salt compartment cap by turning it counter clockwise.

(1) (2) At first use fill the compartment with 1kg salt and water (3) at overflowing level If available. Using a funnel (4) will make filling easier. Refit the cap and close it. After every 20th-30th wash, add salt into your machine until it fills up (approx. 1 kg) Fill the salt compartment with water at first use only. We recommend to use smallgrained or powder softener salt. Do not put table salt into your machine. Otherwise, the function of the softener compartment may decrease over time. When you start machine, the salt compartment gets filled with water. There fore, put the softener salt prior to starting your machine. This way, overflowing salt gets immediately cleaned up through the wash operation. If you will not wash any dishes immediately after putting salt, then run a short washing program with an empty machine in order to avoid corrosion on your machine due to the salt overflow while filling in the salt container. In order to understand whether or not the amount of

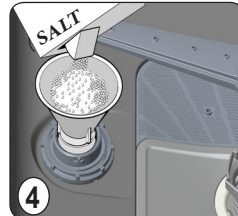
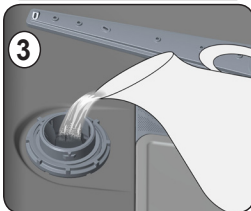
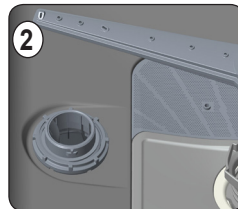

softener salt in machine is sufficient, check the transparent section on the salt compartment cap. There is sufficient salt if the transparent section is green. Salt has to be added if it is not green.

### Testing strip

The washing effectiveness of your machine depends on the softness of the tap water. For this reason, your machine is equipped with a system that reduces the hardness in mains water supply. The washing effectiveness will increase when the system is correctly set. To find out the water hardness level of water in your area, contact your local water board or determine water hardness level by using the test strip(if available).

Open the testing strip	Run water through your tap for 1 min.	Keep the testing strip in water for 1.sec.	Shake the testing strip after taking it out of water	Water for 1 min.	Make your machine's water hardness setting according to the result obtained through the testing strip.																		
					<table border="1"> <tr> <td>Level 1</td> <td></td> <td>No Lime</td> </tr> <tr> <td>Level 2</td> <td></td> <td>Very low lime content</td> </tr> <tr> <td>Level 3</td> <td></td> <td>Low lime content</td> </tr> <tr> <td>Level 4</td> <td></td> <td>Medium lime content</td> </tr> <tr> <td>Level 5</td> <td></td> <td>Lime content</td> </tr> <tr> <td>Level 6</td> <td></td> <td>High lime content</td> </tr> </table>	Level 1		No Lime	Level 2		Very low lime content	Level 3		Low lime content	Level 4		Medium lime content	Level 5		Lime content	Level 6		High lime content
Level 1		No Lime																					
Level 2		Very low lime content																					
Level 3		Low lime content																					
Level 4		Medium lime content																					
Level 5		Lime content																					
Level 6		High lime content																					

## CHAPTER -4: PREPARING THE MACHINE FOR USE

### Adjusting salt consumption

Water hardness level	German hardness dH	French hardness dH	British hardness dH	Water hardness indicator
1	0-5	0-9	0-6	L1 is seen on display.
2	6-11	10-20	7-14	L2 is seen on display.
3	12-17	21-30	15-21	L3 is seen on display.
4	18-22	31-40	22-28	L4 is seen on display.
5	23-31	41-55	29-39	L5 is seen on display.
6	32-50	56-90	40-63	L6 is seen on display.

If the hardness of the water you use is above 90 dF (French hardness) or if you are using well water; you are recommended to use filter and water refinement devices.

**NOTE:** Hardness level is adjusted to level 3(L3) as a factory setting. Adjust the water softener according to how hard your tap water is. .

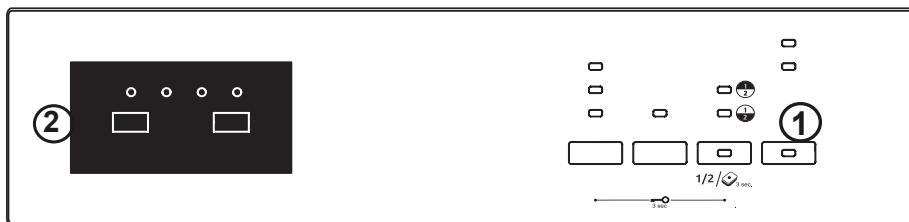

- Press program button(2) when the machine is off position.
- Turn on the machine by pressing On/Off button(1) and continue to press program button(2) at least for 3 seconds.
- If "Hardness set" is recognized "SL" is shown for 2 seconds.
- Release program button(2). The last setting level is viewed.
- Press program button(2) to set the desired level. At any pressure of program button hardness level is incremented. Hardness level 1 returns after hardness level 6.
- The last selected water hardness level is stored in the memory by turning the machine off with On/Off button(1).

### Detergent usage

Use a detergent specifically designed for use in domestic dishwashers.

You can find powder, gel, and tablet detergents that have been designed for household dishwashers.

Detergent should be put into the compartment prior to starting the machine. Keep your detergents in cool, dry places out of reach of your children.

Do not overfill the detergent compartment; otherwise it may cause scratches on your glasses as well as lead to a poorly dissolved detergent.

Should you need more information concerning the detergent you will use, contact the detergent manufacturers directly.

### Filling the detergent compartment

Push the latch to open the detergent container as shown in the image. 1 The Detergent pod has level lines inside. The Detergent pod can take a total of 40 cm<sup>3</sup> of detergent. Open the dishwasher detergent and pour into the larger compartment **b** 25 cm<sup>3</sup> if dishes are heavily soiled or less 15 cm<sup>3</sup>. 2 If dishes have been kept dirty for a very long time with, dried food waste on them or the dishwasher has been overloaded pour **a** 5cm<sup>3</sup> of detergent into the prewash compartment and start the machine. You may have to add more detergent into your machine, depending on the degree of soil and on the water hardness level in your area.

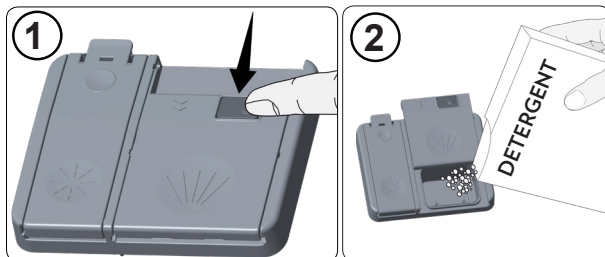

## CHAPTER -4: PREPARING THE MACHINE FOR USE

### Combined detergents

Combined detergents may include various properties in them. Before using a detergent, please read and follow the instructions well. Generally, combined detergents produce sufficient results only under certain conditions.

### Points to consider when using these types of products:

- Check the specifications of the product whether it is combined or not.
- Check if the detergent used is appropriate for the hardness of the main water supply.
- Read the instructions of the products on the packagings.
- Always put the tablets into the detergent compartment in the detergent dispenser.
- You need to contact the manufacturers and find out about the suitable conditions of use.
- If you use appropriate products, they can ensure savings in salt and/or rinse agent consumption.
- The scope of the warranty for your machine does not cover any complaints caused by the use of these types of detergents.

**Recommended usage:** If you want to obtain better results while using combined detergents, add salt and rinse agent into your machine and adjust the water hardness setting and the rinse aid setting to the lowest position.



The solubility of the tablet detergents produced by different companies can vary depending on the temperature and time. Therefore, the use of such detergents in short programmes is not recommended. It is more suitable to use powder detergents for such programmes.

**Warning:** Should any problem, which you have not encountered before arise with the use of this type of detergents, contact the detergent manufacturers directly.

### When you give up using combined detergents

- Fill the salt and rinse agent compartments.
- Adjust the water hardness setting to the highest position and run an empty-wash.
- Adjust the water hardness level.
- Set the suitable rinse agent setting.

### Filling with rinse agent and making the setting

To fill the rinse aid compartment, open the rinse-aid compartment cap. Fill the compartment with rinse aid to the MAX level and then close the cap. Be careful not to overfill the rinse aid compartment and wipe up any spills.

**In order to change the rinse aid level, follow the below steps before turning on the machine:**

- Push the programme button and hold it down.
- Turn on the machine.
- Hold down the programme button until “rA” disappears from the display. Rinse aid setting follows water hardness setting.
- The machine will display the last setting.
- Set the level by pushing the programme button.
- Switch off the machine to save the setting.
- The factory setting is “4”.

If the dishes are not drying properly or are spotted, increase the level. If blue stains form on your dishes, decrease level.

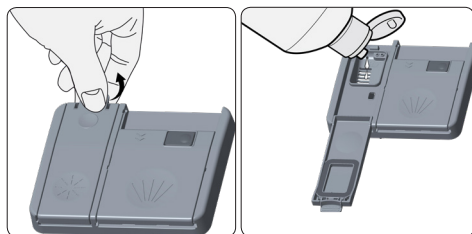

Level	Brightener Dose	Indicator
1	Rinse-aid not dispensed	r1 is shown on the display.
2	1 dose is dispensed	r2 is shown on the display.
3	2 doses are dispensed	r3 is shown on the display.
4	3 doses are dispensed	r4 is shown on the display.
5	4 doses are dispensed	r5 is shown on the display.

## CHAPTER-5: LOADING YOUR DISHWASHER

### LOADING YOUR DISHWASHER

Place dishes properly into the machine.

There are two separate baskets to load dishes into your machine. The lower basket is for round and deep items. The upper basket is for thin and narrow items. You are recommended to use the cutlery basket in order to obtain the best result.

To avoid any possible injuries, place long-handle and sharp-pointed knives with their sharp points facing down or horizontally on the baskets.

**Warning:** Place your dishes into your machine in a way that they will not prevent the upper and lower spray arms from spinning.

### SOFT TOUCH

#### Height Adjustable Rack

These racks are designed to increase the capacity of the top basket. You can place your glasses and cups on the racks. You can adjust the height of these racks. Thanks to this feature, you can place different sizes of glasses under these racks. Thanks to height adjustment plastics mounted on the basket, you can use your racks in 2 different heights. In addition, you can place long forks, knives and spoons on these racks laterally, so that they do not block the revolution of propeller. The soft touch feature on the racks serves to place the fine stemmed glass. The wineglass is placed in the area shown at the picture.

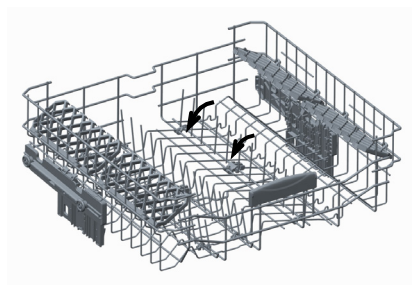
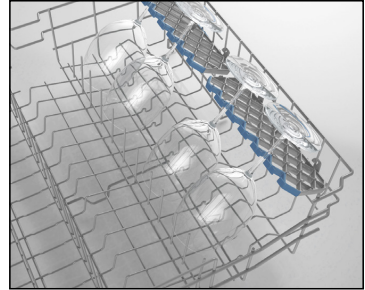

#### Foldable racks

Foldable racks on the upper basket are designed in order to let you place big items easier such as pots, pans, etc. If requested, each part can be folded separately, or all of them can be folded and larger spaces can be obtained. You can use foldable racks by raising them upwards, or by folding down.



## CHAPTER-5: LOADING YOUR DISHWASHER

### Top basket height adjustment while it is full

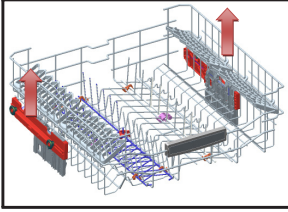

The basket height adjustment mechanism on the top basket of your machine is designed to let you adjust the height of your top basket upwards or downwards, without removing it from your machine when it is full, and create large spaces at the top or bottom area of your machine as needed. The basket of your machine is set to the upper position in factory settings. In order to raise your basket, hold it from both sides and pull it upwards. In order to lower it, hold it from both sides again, and leave it. In the loaded basket adjustment mechanism, make sure that both sides are in the same position (up or down).

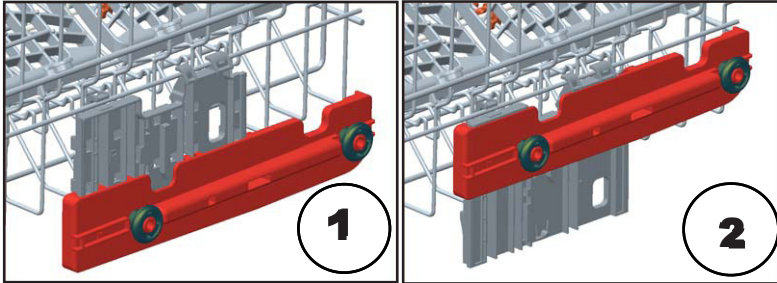

### Lower Basket Folding Racks

Folding racks consisting of two parts that are located on the lower basket of your machine are designed in order to let you place big items easier such as pots, pans, etc. If requested, each part can be folded separately, or all of them can be folded and larger spaces can be obtained. You can use folding racks by raising them upwards, or by folding them down.

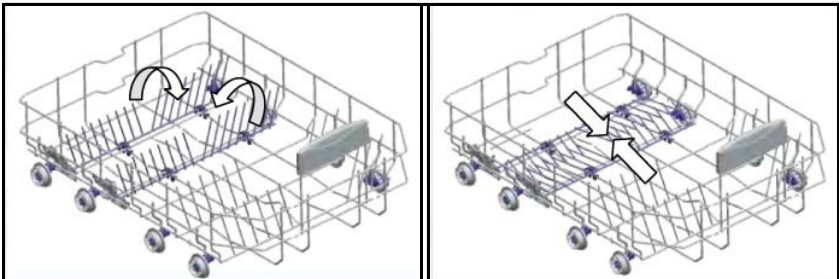

## CHAPTER-5: LOADING YOUR DISHWASHER

### Alternative basket loads Lower Basket



### Top basket

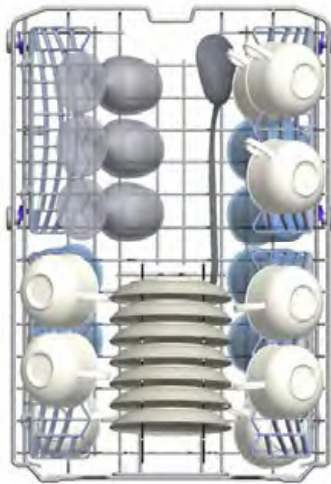

## CHAPTER-5: LOADING YOUR DISHWASHER

### Faulty loads

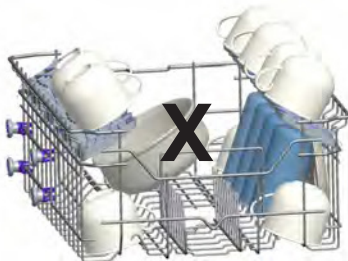
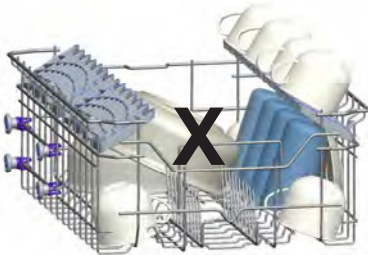
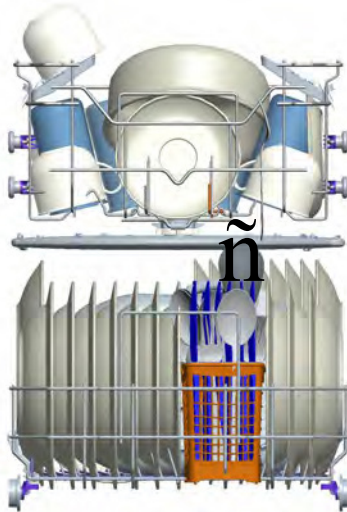

### Important Note for Test Laboratories

For detailed information on performance tests, please contact following address: "dishwasher@standardtest.info" . In your email, please provide the model name and serial number (20 digits) which you can find on the appliance door.

## CHAPTER -6: PROGRAMME DESCRIPTIONS

### Programme items

Programme No	1	2	3 Reference	4
Programme names	Prewash	Quick 30'	Eco	Daily
Temperatures	No Heat	40°C	50°C	60°C
Type of food waste	Prewash to rinse and loosen residues on the soiled dishes that will be waited for a few days	coffee, milk, tea, cold meats, vegetables, not kept for long	coffee, milk, tea, cold meats, vegetables, not kept for long	Fresh coffee, milk, tea, cold meat, vegetables
Level of soil	-	Small	Medium	Medium
Detergent amount B: 25 cm <sup>3</sup> / 15 cm <sup>3</sup> A: 5 cm <sup>3</sup>	-	B	A+B	A+B
	Prewash	40°C wash	Prewash	Prewash
	End	Cold rinse	50°C wash	60°C Wash
		Hot rinse	Hot rinse	Cold Rinse
		End	Dry	Hot Rinse
			End	Dry
			End	
Programme duration(min.)	15	30	198	94
Electricity consumption (kW hours)	0,02	0,67	0,73	13,1
Water Consumption (liters)	4,2	9,9	9,0	14.4

**Warning:** Short programs do not include a drying step. The values declared above are the values obtained under laboratory conditions according to relevant standards. These values can change depending on conditions of product's use and environment (network tension, water pressure, water input temperature and environment temperature).

## CHAPTER -6: PROGRAMME DESCRIPTIONS

### Programme items

Programme No	5	6	7	8	9
Programme names	Express 50 min.	Delicate	Normal	Intensive	Steamwash
Temperatures	65°C	40°C	55°C	65°C	65°C
Type of food waste	soups, sauces, pasta, eggs, pilaf, potato and oven dishes, fried foods	Detects contamination level of dishes and sets temperature and amount of washing water and washing period automatically.			soups, sauces, pasta, eggs, pilaf, potato and oven dishes, fried foods
Level of soil	Medium	Small	Small	Medium	Medium
Detergent amount B: 25 cm <sup>3</sup> / 15 cm <sup>3</sup> A: 5 cm <sup>3</sup>	A+-B	A+-B	B	A+-B	A+-B
	65°C wash	Washing steps are determined automatically according to the level of soil.			Prewash
	Intermediate rinse				65°C wash
	Hot rinse				Cold rinse
	End				Intermediate rinse
					Hot rinse
					Dry
					End
Programme duration(min.)	50	66-80	88-104	106-152	161
Electricity consumption (kW hours)	1,35	0.80 - 0.99	1.13 - 1.46	1.30 - 1.95	30
Water Consumption (liters)	9,9	9.7-16	9.6-16.1	10-20	17

## CHAPTER -7: SWITCHING ON THE MACHINE AND SELECTING A PROGRAMME

### Programme Selection and Operating the Machine

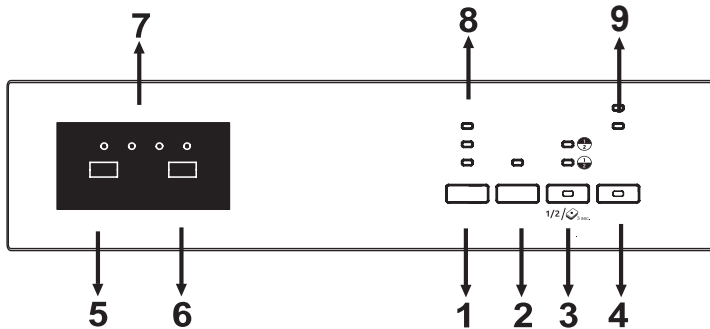

By pressing On/Off button(4), energise the machine. On/Off lamp lights as long as the machine is on.

Select the suitable programme by pressing Program button(5).

Press Start/Pause button (6) to start the program. Next, Wash lamp turns on and Remaining Time Indicator(7) shows the program duration. It also indicates the remaining time during the program flow.

If you open the door of your machine while program is continuing, duration of program pauses, program number and program duration are shown alternately.

Program flow can be monitored via Wash, Rinse Dry and End lamps on the Remaining Time Indicator(7). Machine remains silent for about 40-50 minutes when the drying lamp is on.

**NOTE:** By pressing half load button(3), three sorts of washing can be executed that are in both baskets, upper basket and lower basket. Press until the lamp of basket containing dishes to be washed is on. No dishes certainly exist in the basket which will not be washed.

**NOTE:** Press Half load button for 3 seconds to activate Tablet option when using combined detergent that contains salt, rinse aid and extra functions.

**NOTE:** You may select Hygiene in order to obtain hygienic and a cleaner washing process by altering the water temperature and washing time of the program you have selected.

**NOTE:** If Rinse option is selected, washing-rinsing steps will be added into the selected program, so you can ensure that your dishes will be extracted cleaner and glossier.

**NOTE:** If Drying lamp is on, extra heating and drying steps will be added into the selected program, so you can ensure that your dishes will be extracted dryer.

**NOTE:** If you have used an extra feature on the latest washing program, this feature will remain active also on the next washing program. If you want to cancel this feature on the newly selected washing program, press Extra(1), Delay(2) or Half load button(3) until related lamps are off or turn the machine off with On/Off button(4). If you would like to use extra feature with newly selected program, select the desired functions.

**NOTE:** Child lock is activated/deactivated by pressing both "Extra"(1) and "Half Load"(3) buttons for about 3 seconds. When it is activated, all leds blink and "CL" is shown on Remaining Time Indicator(7) once. When it is deactivated, all lamps and "CL" blink twice.

**NOTE:** You can delay start time of the program for 1-2...19 hours by pressing delay button(2) before program starts. If you want to change delay time, first press Start/Pause button and then delay button to select new delay time. To activate new delay time, press Start/Pause button. To cancel the delay, you need to switch to 0 hour by using the delay button.

**NOTE:** If user switches the machine to off position after selecting the delay time and the programme has started, delayed time is cancelled.

**NOTE:** When softening salt is not enough, salt lack warning indicator (9) turns on and you need to fill in the salt chamber.

**NOTE:** When rinse aid is not enough, rinse aid lack warning indicator (9) turns on and you need to fill in rinse aid chamber.

## CHAPTER -7: SWITCHING ON THE MACHINE AND SELECTING A PROGRAMME

### Changing a programme

If you would like to change the program while washing is continuing.

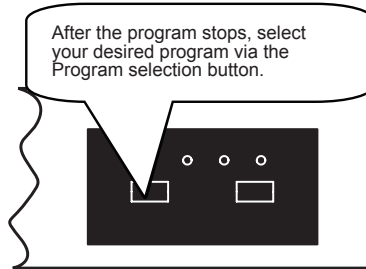
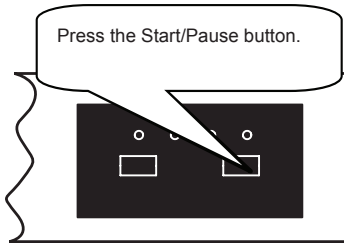

Start newly selected program by pressing Start/Pause button.

The new program started will resume the course of the old program.

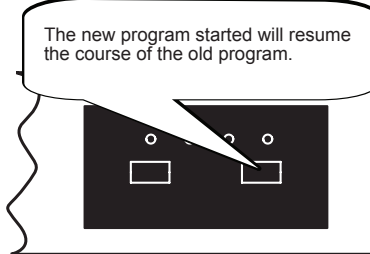

### Cancelling a programme

If you would like to cancel a program while washing is continuing.

Press Start/Pause button for 3 seconds.

During cancellation, End light blinks. The machine discharges the water inside it about 30 seconds.

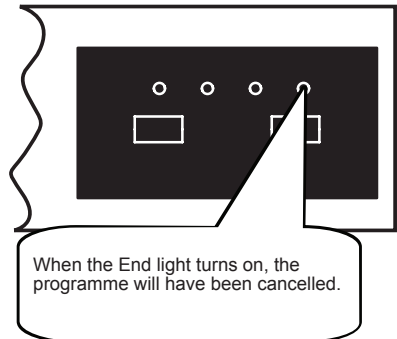
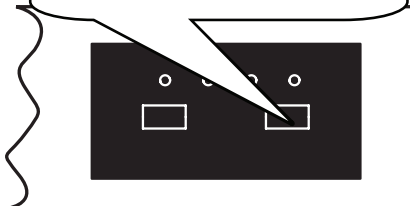

## CHAPTER -7: SWITCHING ON THE MACHINE AND SELECTING A PROGRAMME

### Switching the Machine Off

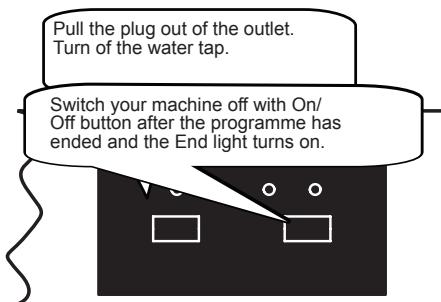

**NOTE:** Do not open the door before the program ends.

**NOTE:** At the end of washing program, you can leave the door of your machine ajar to fasten the drying.

**NOTE:** If the door of machine is opened or power is cut off during washing, program will continue when the door is closed or the power is back.



## CHAPTER -8: MAINTENANCE AND CLEANING

Cleaning the machine regularly prolongs the machine's service life.

**Oil and limescale may accumulate in the machine's washing section. In case of such accumulation;**

-Fill the detergent compartment without loading any dishes into the machine, run the machine at high temperature. If this does not work, use special cleansing materials.

**Cleaning the seals in the machine door,**

-Wipe the seals regularly by using a dampened cloth.

**Cleaning machine,**

Clean the filters and spray arms at least once a week.

Unplug your machine and turn off its tap before starting the cleaning.

Wipe with a fine cleaning material and a dampened cloth.

**Filters**

If any food wastes have remained on the coarse and fine filters, remove the filters and clean them thoroughly under the water tap.

a. Micro Filter

b. Coarse Filter

c. Metal/Plastic Filter

To remove and clean the filter combination, turn it counter clockwise and take it out by lifting upwards. **1**

Pull and remove the metal/plastic filter. **2** Then pull the coarse filter out of the micro filter. **3** Rinse it with lots of water under the tap. Refit the metal/plastic filter. Insert the coarse filter into the micro filter in a way that the marks correspond to one another. Attach micro filter into the metal/plastic filter and turn to the direction of arrow and it is locked when the arrow on micro filter can be seen from across. **4**

• Never use your dishwasher without a filter.

• Incorrect fitting of the filter will reduce the washing effectiveness.

• Clean filters are very important in terms of the proper running of the machine.

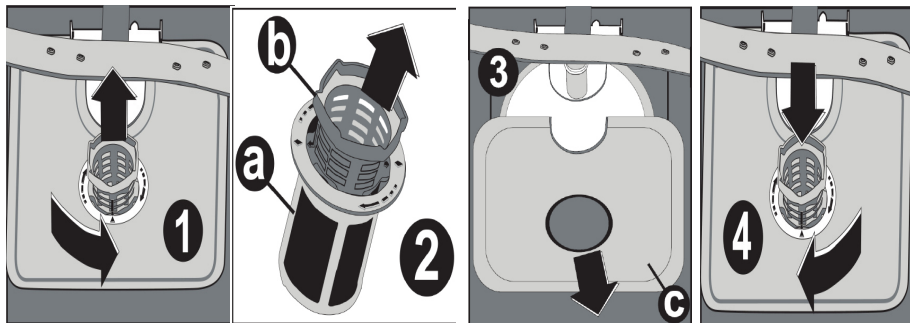

**Spray arms**

Check the holes for the upper and lower spray arms. If there is any clogging, remove the spray arms and clean them under water.

You can remove the lower spray arm by pulling it upwards, while the upper spray arm nut can be removed by turning the nut to the left. Be sure that the nut is perfectly tightened when refitting the upper spray arm.

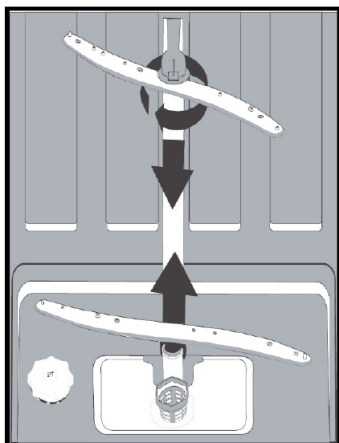

**Hose filter**

Check the filter and the hose from time to time and clean them to prevent yellowing and formation of deposits after washing. To clean the filter, first turn off your tap and then remove the hose. After removing the filter from the hose, clean it under the tap. Insert the cleaned filter back into its place inside the hose. Refit the hose.

## CHAPTER -9: FAILURE CODES AND WHAT TO DO IN CASE OF FAILURE

ERROR CODE	ERROR DESCRIPTION	CONTROL
F5	Inadequate water supply	<ul style="list-style-type: none"> <li>• Make sure the water input tap is totally open and that there is no water cut.</li> <li>• Close the water input tap, separate the water input hose from the tap and clean the filter at the connection end of the hose.</li> <li>• Restart your machine, contact for service if the error resumes.</li> </ul>
F3	Error of continuous water input	<ul style="list-style-type: none"> <li>• Close the tap.</li> <li>• Contact service.</li> </ul>
F2	The waste water in the machine cannot be discharged.	<ul style="list-style-type: none"> <li>• Water discharge hose is clogged.</li> <li>• The filters of your machine might be clogged.</li> <li>• Power off-on your machine and activate the program cancellation command.</li> <li>• If the error continues, contact for service.</li> </ul>
F8	Heater error	<ul style="list-style-type: none"> <li>• Contact for service.</li> </ul>
F1	Alarm is active against water overflow	<ul style="list-style-type: none"> <li>• Power off your machine and close the tap.</li> <li>• Contact for service.</li> </ul>
FE	Faulty electronic card	<ul style="list-style-type: none"> <li>• Contact for service.</li> </ul>
F7	Overheating error (temperature in the machine is too high)	<ul style="list-style-type: none"> <li>• Contact for service.</li> </ul>
F9	Divisor position error	<ul style="list-style-type: none"> <li>• Contact for service.</li> </ul>
F6	Faulty heater sensor	<ul style="list-style-type: none"> <li>• Contact for service.</li> </ul>

**If one of the program monitor lights is on and start/pause light is on and off,**  
Your machine's door is open, shut the door.

**If the programme won't start**

- Check if the plug is connected.
- Check your indoor fuses.
- Be sure that the water inlet tap is turned on.
- Be sure that you have closed the machine door.
- Be sure that you switched off the machine by pressing the Power On / Off button.
- Be sure that the water inlet filter and the machine filters are not clogged.

**If the lamps "Wash/Dry" and "End" keep flashing**

- The water overflow alarm is active
- Turn off your tap and contact the Sharp helpdesk.

**If the control lamps won't go out after a wash operation**

Check if the Power On/Off button is released.

**If detergent residues are left in the detergent compartment**

Detergent has been added when the detergent compartment was wet.

**If water is left inside the machine at the end of the programme**

- The water drain hose is clogged or twisted.
- The filters are clogged.
- The programme is not finished yet.

**If the machine stops during a wash operation**

- Power failure.
- Water inlet failure.
- Program can be on standby mode.

**If shaking and hitting noises are heard during a wash operation**

- Dishes placed incorrectly.
- Spray arm hitting the dishes.

**If there are partial food wastes left on the dishes**

- Dishes placed incorrectly into the machine, sprayed water did not reach related places.
- Basket overly loaded.
- Dishes leaning against one another.
- Small amount of detergent added.
- An unsuitable, rather weak wash programme selected.
- Spray arm clogged with food wastes.
- Filters clogged.
- Filters incorrectly fitted.
- Water drain pump clogged.

## CHAPTER -10: PRACTICAL AND USEFUL INFORMATION

### **If there are whitish stains on the dishes**

- insufficient detergent is being used
- Rinse aid dosage setting at a very low level.
- No special salt is being used despite the high degree of water hardness.
- Water softener system setting is at a very low level.
- Salt compartment cap not closed well.

### **Won't dry no need for dry**

- A programme without a dry operation has been selected.
- Rinse aid dosage set too low
- Dishes unloaded too fast.

### **If there are rust stains on the dishes**

- Stainless-steel quality of the dishes washed is insufficient.
- High rate of salt in the wash water.
- Salt compartment cap not properly closed.
- Too much salt spilt into the sides and into the machine while filling it with salt.
- Poor mains grounding.

**Call an authorised service if the problem still persists after the controls or in case of any malfunction not described above.**

### **PRACTICAL AND USEFUL INFORMATION**

- 1- When you won't be using your machine for an extended period
  - Unplug the machine and then turn the water off.
  - Leave the door slightly ajar in order to prevent the formation of unpleasant smells.
  - Keep the machine interior clean.
- 2- Eliminating water droplets
  - Wash the dishes with the intensive programme.
  - Take all of the metal containers in the machine out.
  - Do not add detergent.
- 3- If you properly place your dishes into the machine, you will be using it in the best way in terms of energy consumption, washing and drying performance.
- 4- Clean all rough waste before you place dirty dishes to the machine.
- 5- Operate the machine after it is completely full.
- 6- Use a pre-washing program only when necessary.
- 7- Observe program information and average consumption values table when selecting a program.
- 8- Since the machine will reach high temperatures, it should not be placed near a refrigerator.
- 9- If the appliance is located in a place where the risk of freezing exists, you must completely drain the water that has remained in the machine. Turn off the water tap, disconnect the water inlet hose from the tap and allow the interior water to drain.

The dishwasher contains biocidal product in the PP sump filter to prevent bacterial growth.  
Active Substance: zinc pyrithione (CAS No: 13463-41-7)

## DISPOSAL OF YOUR OLD MACHINE

This symbol on the product or package implies that the product should not be treated as domestic waste. Instead, it should be delivered to waste collection places recycling electrical and electronic equipment. You will help avoid damage to the environment and risks to public health. Recycling materials will help natural resources to be preserved. For more detailed information regarding recycling of this product, please contact your local authority or the shop where you purchased the product from.





# Service & Support

Visit Our Website  
[sharphomeappliances.com](http://sharphomeappliances.com)

**SHARP**

Be Original.

52267931 R36